

# THE AUTONOMY-ORIENTED APPROACH AS A WAY TO DEVELOP HIGHER MEDICAL EDUCATION

O.A. Gavrilyuk<sup>1</sup>

<sup>1</sup>*Department of Latin and Foreign Languages, V.F. Voino-Yasenetsky Krasnoyarsk State Medical University, Krasnoyarsk, Russian Federation*

## Abstract

The paper emphasises the potential of the autonomy-oriented approach as a scientific basis for the development of innovative training practices in medical universities of Russia. Based on a review of research, theory, and current teaching practices in Professor V.F. Voino-Yasenetsky Krasnoyarsk State Medical University, the paper considers both theoretical and practical aspects of the autonomy-oriented approach implementation in higher medical education. The benefits of the autonomy-oriented approach for both undergraduate and postgraduate medical students are demonstrated from the perspective of the Self-Determination Theory. Our findings indicate that the autonomy-oriented approach in higher medical education is associated with a more “personalised” teaching style through supporting students’ self-determination, engagement and autonomy. The summative evaluation of the results of the study with participation of 54 medical students and 33 medical university teachers suggests that the use of the autonomy-oriented approach in higher medical education leads to effective implementation of creative, innovative, contextual and problem-based training techniques as well as students’ and teachers’ personal and professional self-development.

## Keywords

*higher education • autonomy • autonomy-oriented approach • training process • university teachers • medical students*

## Introduction

The current Russian system of higher medical education is undergoing a variety of progressive changes. Among these, of special note is implementation of new methods and forms of training organisation (workshops, case-studies, video-conferences, academic exchanges, counselling, various types of distance learning courses and networking cooperation, etc.). Nevertheless, this system remains insufficient in view of some factors.

First, despite the presence of positive educational initiatives in contemporary Russian theory and practice of higher medical education, there is lack of a holistic and comprehensive approach to teachers’ and students’ personal and professional development problem;

Second, most of training courses are organised on the basis of the formal approach and are oriented toward formal transition (using traditional forms and methods of training) of a certain volume of information to students but not toward achievement and development of students’ competences and their professional growth;

Third, the present level of knowledge, the student’s personal potential are not always considered when medical training is organised;

Fourth, there are many university teachers who are not ready

to face the modern challenges of higher medical education, completely rethink traditional study goals and strategies of teaching in order to provide optimal challenges for students, ensure a diversity of learning experiences, built in accordance with the possibilities and the needs of all student categories, making students feel competent, supporting their autonomy [1-2] and internationalising the content of higher education [3]. Fifth, despite proclaimed transformation of the whole healthcare system from one-size-fits-all approach into a subject-oriented one [4], in the current situation of basic values revision scientific achievements in the practice of healthcare often lead to the dehumanisation of medicine and, consequently, medical education [5]. Accordingly, it is vital to find relevant scientific basis for new training practices to develop future doctors’ humanistic and values-based attitude to patients and their health.

Another concern regarding contemporary medical education is the problem of medical students’ readiness for self-directed lifelong learning which is reported to be an integral part of medical professionalism [6].

To make higher medical education more responsive to the changes taking place in the medical community, it is critical to completely rethink traditional study goals and strategies and

follow the ideas of a humanistic education model, based on student-centred approach and “transformational pedagogy” [7, 8]. Prioritising innovative, proactive and creative human nature, this model puts emphasis on interests of the students with consideration for their personal experience, inclinations, abilities, and ensures practice-based and personality-oriented implementation of new educational technology [9] to develop future doctors’ humanistic qualities and their professional autonomy [10].

Therefore, an acute necessity is emerging today to develop scientifically grounded personality-oriented training practices that may be used in higher medical education. Following the presented statements, *the aim of this article* is to explore the autonomy-oriented approach as a scientific basis for the development of innovative training practices in medical universities of Russia.

## Methods

Taking into account that teaching is suggested to be an important factor influencing students’ motivation and performance [11-13] and teacher’s personal qualities are reported to be more important in motivating students than the teaching methods and classroom management practices [14-15], we studied the potential of students and teachers’ autonomy in the context of higher education [16-18] using analytical and descriptive methods of the literature review. Modern approaches and technologies for organisation of student-centred training in higher education have been explored as well [7, 8, 19]. The study problem required a more detailed exploration of R. Ryan & E. Deci’s self-determination theory (SDT), in which self-determination is considered as feeling and realisation of freedom in person’s choice of behaviour and existence in the world independently from external environment and inner-personal processes effects [20].

In addition to psychological and pedagogical theory studying, this research included analysis of modern higher medical education practice, which was conducted within the framework of open discussions in pedagogical conference workshops and round-table discussions with participation of the university faculty (10 teachers of medical English – members of the Linguistic Centre of Professor V.F. Voino-Yasenetsky Krasnoyarsk State Medical University (KrasSMU) and medical students – members of the KrasSMU Centre for Intercultural Communication (54 medical students, including 44 first- and second-year students and 10 postgraduates) in 2013-2017.

The practical aspects of the autonomy-oriented approach were also investigated through applying the ideas of autonomy-oriented education to the introduction of the “School of the young teacher” course for 23 young medical university

teachers (2015-2016) and advanced training programme for 10 teachers of Medical English – members of the KrasSMU Linguistic Centre (2016-2017).

## Results

Our research results make it possible to suggest that the autonomy-oriented approach in higher education represents a methodological approach to the training process organisation that fosters both students’ and teachers’ autonomy through supporting their personal involvement into the training process as well as their personal responsibility for its results.

In view of this, the choice of the autonomy-oriented approach as a scientific basis for the development of innovative training practices in medical universities is first of all determined by the content of the “autonomy” notion.

Autonomy in healthcare practice is reported to allow junior doctors to feel ready for more senior, unsupervised roles, to work more in difficult scenarios involving team leadership and risk acceptance [10]. Autonomy in the educational context is associated with creation of a new, subject-oriented type of education [21], growth of one’s independence, personal empowerment, ability to make decisions and choices [22, 23]. A lot of modern conceptions of autonomy in education emphasise teachers’ or/and students’ capacity to take control of their own activities through planning, making choices and taking responsible decisions. As it was revealed, perceived autonomy represents a high-level competence, which allows teachers and students to take control of their activities and to develop as self-determined and socially responsible educational actors.

Autonomy is associated with a set of personal characteristics, including intrinsic motivation to professional achievement and personal and professional development, internal locus of control, responsibility, creativity, ability to set goals make decisions and to make choices, ambiguity tolerance and critical mindfulness. Within the framework of medical education, it makes processes of learning and teaching inner-directed, and, consequently, desirable and enjoyable both for students and teachers [24].

In terms of theory, implementation of the autonomy-oriented approach is based on personalisation of the educational process within the framework of personality-oriented paradigm of higher education. Such personalisation requires the use of novel educational techniques in students’ training as well as in advanced training for teachers. These new techniques should be aimed at formation of students and teachers’ personal attitude towards the educational process and based on the mechanisms of dialogue, reflexivity and cooperation, providing educational actors’ personal involvement into the training process and their personal responsibility for its results.

Applying the ideas outlined above to teaching practice at a medical university and based on the literature review, we specified the core characteristics of the autonomy-oriented approach compared to the traditional approach to teaching in Table 1.

Analysing the revealed characteristics of the autonomy-oriented approach within the modern educational context allowed us to assume that using the autonomy-oriented approach in medical universities can stimulate certain changes in both teachers and students. The most important of these changes is the transformation of their external locus of control into the internal one.

To achieve this transformation, the following conditions are to be provided in the university educational environment:

1. Ensuring teachers' and students' awareness and a deep understanding of the educational process characteristics based on maximal accessibility of information about aims, goals, processes, methods of learning outcomes evaluation, etc.;
2. Providing opportunities for students' and teachers' personal and professional development by means of organisation of their access to a wide range of data resources;
3. Empowering teachers and students to actively participate and succeed in different aspects of educational, scientific and other types of activity and thus stimulating their responsibility (in contrast to accountability) for educational outcomes;
4. Organisation of an effective system of feedback between the administration of the university, the teaching staff, and the students;

5. Providing both students and teachers with opportunities for making choices of forms and types of activities, as well as opportunities for self-expression and creative work, including their participation in the development of the university educational environment;

6. Supporting teachers' and students' self-esteem and stimulating their positive professional competition by means of a rating (portfolio) system implementation;

7. Stimulation of interaction between teachers and students both inside the university educational environment and outside of it and their involvement in innovative activities.

The autonomy-oriented approach to the organisation of training in medical universities was seen as beneficial by all the study participants who emphasised the great value of students' and teachers' autonomy support in the educational setting of medical universities.

The summative evaluation of the study results suggests that the autonomy-oriented approach to the organisation of training in medical universities is potentially valuable in a number of ways.

First, it involves creation of autonomy-oriented informational-educational environment that comprises intellectual, cultural, methodological, technological resources and communication technology tools providing access to a wide range of educational resources and allowing for innovative and creative activity.

Second, it allows both teachers and students to take ownership of their sustainable personal and professional

**Table 1.** Characteristics of the traditional and the autonomy-oriented teaching

TRADITIONAL TEACHING	AUTONOMY-ORIENTED TEACHING
Theorised syllabus	Practice-oriented syllabus
Overview of some language phenomena	Emphasis on profession, interdisciplinarity: and on students' ability to apply new knowledge to their actual contexts of learning
Emphasis on transmission of information to the audience	Emphasis on students' involvement into the educational process, their active participation in making sense of a new practice using their own metacognitive skills to create their multi-dimensional awareness of the educational context Teacher functioning as a facilitator Provided opportunity for experiential, collaborative learning
Beaming down of a generic course content Adherence to a fixed curriculum	Provided opportunity to select what students would like to learn. Critical review and use of students' personal experience
Emphasis on quantitative equipment of students with new learning techniques	Emphasis on both qualitative innovational self-development of learners and their creativity
Token approach to teaching	Teaching as a stimulus for students' lifelong personal and professional development Provided opportunities for students to coach one another and work together to analyse new learning techniques
Summative evaluation of students by teachers	Multi-dimensional evaluation (fostering self-evaluation and peer-evaluation practices)
Use of old (or new) methods that may be not relevant for the students and may not relate to their specific demands	Relevant content, reflecting actual challenges faced by students in their learning (professional) activity
Non- problematic, non-diversified content Providing basic knowledge	Content construction on the basis of interdisciplinary problems topical in the in the broad context of a medical profession

development [25] as well as to stay current in their fields through constant reevaluation of their own experience and reflective development in and beyond the university educational environment.

## Discussion

Our overall findings, based on the literature review results and the results of the practical part of our investigation, allowed us to prove our theoretical ideas concerning the benefits of the autonomy-oriented approach for the development of innovative training practices in medical universities of Russia.

Creation of the described complex of conditions will make it possible to implement the autonomy-oriented approach through stimulating recognition by teachers and students of their own leading role in the development of university educational environment as well as their personal responsibility and volition to overcome difficulties and develop their abilities and potential. These changes in turn will provide the transformations of teachers' and students' external locus of control into the internal one.

Providing an autonomous type of teacher's behaviour, this approach will ensure teachers' support of students' autonomy, teachers' role as facilitators and coordinators of the students' discovery and creative learning. This will allow teachers to stimulate medical students' intrinsic motivation to learn through making them know why to learn (demonstrating connections between learning and emotions or the practical application of knowledge and encouraging their initiative and curiosity), how to learn, and creating a relevant feedback system during training.

The autonomy-oriented approach makes both students and teachers active, reflective and critical educational environment actors who try to understand, rather than memorise the educational content. This benefit of the autonomy-oriented approach makes it close to the ideas of social constructivist philosophy and constructivism-based teaching [26-27] and emphasises its holistic character.

The conducted research made it possible to draw the conclusion that application of the autonomy-oriented approach to the process of training in a medical school allows for transition from formal training to self-determined continuous personal and professional development of both students and teachers. Consequently, this makes higher education system responsive to the changes taking place in the modern Russian society and contributing to an accelerating paradigm shift toward personalised medicine.

Practical relevance of the study has been ensured through specifying the autonomy-oriented approach in higher education and defining a set of conditions, which are suggested to guide the implementation of this approach within the university educational environment. Outlining the characteristics of autonomy-oriented teaching in a medical university setting, the study allows for possible application of the autonomy-oriented approach in other educational contexts.

Several important study limitations need to be considered. First, this study used self-reported data, which may pose concerns around social desirability bias. However, various forms of training and communication allowed the study participants to respond using the full range of response options, yielding evidence against social desirability bias.

Second, the analysis of autonomy-oriented approach application in medical education presented in this paper is largely qualitative and is limited to the results of literature review as well as teaching and discussion practices among a small sample size of the study participants inside the university educational environment of KrasSMU. Studies targeting the broader higher medical education community might be able to provide quantitative analytics that could be used to reveal other possible aspects of autonomy-oriented approach implementation and its benefits for innovative development of higher medical education.

## Conflict of interest statement

The author has no conflicts of interest to disclose.

## References

1. Niemiec CP, Ryan RM. Autonomy, competence, and relatedness in the classroom: Applying self-determination theory to educational practice. *Theory Res Educ.* 2009;7(2):133–44. <https://doi.org/10.1177/1477878509104318>
2. Kusurkar RA, Croiset G, Ten Cate TJ. Twelve tips to stimulate intrinsic motivation in students through autonomy-supportive classroom teaching derived from self-determination theory. *Med Teach.* 2011;33(12):978–82. <https://doi.org/10.3109/0142159X.2011.599896>
3. Svensson L, Wihlborg M. Internationalising the content of higher education: the need for a curriculum perspective. *High Educ.* 2010;60(6):595–613. <https://doi.org/10.1007/s10734-010-9318-6>



4. Pritchard DE, Moeckel F, Villa MS, Housman LT, McCarty CA, McLeod HL. Strategies for integrating personalized medicine into healthcare practice. *Personal Med.* 2017;14(2). <https://doi.org/10.2217/pme-2016-0064>
5. Bates V. Yesterday's Doctors: The Human Aspects of Medical Education in Britain, 1957–93. *Med Hist.* 2017;61(1):48–65. <https://doi.org/10.1017/mdh.2016.100>
6. Li CT, Paterniti DA, Co JP, West DC. Successful self-directed lifelong learning in medicine: a conceptual model derived from qualitative analysis of a national survey of pediatric residents. *Acad Med.* 2010;85(7):1229–36. <https://doi.org/10.1097/ACM.0b013e3181e1931c>
7. Rogers CR. *Freedom to Learn for the 80's.* Columbus, OH: Charles E. Merrill Publishing Company; 1983.
8. O'Hara M. Cultivating Consciousness. Carl R. Rogers's Person-Centered Group Process as Transformative Androgogy. *JTED.* 2003;1(1):64–79. <https://doi.org/10.1177/0095399703251646>
9. Forzani FM. Understanding “core practices” and “practice-based” teacher education: Learning from the past. *J Teach Educ.* 2014;65(4):357–68. <https://doi.org/10.1177/0022487114533800>
10. Oliver D. Supervision and clinical autonomy for junior doctors – have we gone too far? *BMJ.* 2017; 359:j4659. <https://doi.org/10.1136/bmj.j4659>
11. Noels KA, Clement R, Pelletier LG. Perceptions of teachers' communicative style and students intrinsic and extrinsic motivation. *Mod Lang J.* 1999;83(1):23–34.
12. Davies B, Leung A, Dunne S. So how do you see our teaching? Some observations received from past and present students at the Maurice Wohl Dental Centre. *Eur J Dent Educ.* 2012;16(3):138–43. <https://doi.org/10.1111/j.1600-0579.2012.00733.x>
13. Jahangiri L, McAndrew M, Muzaffar A, Mucciolo TW. Characteristics of effective clinical teachers identified by dental students: a qualitative study. *Eur J Dent Educ.* 2013;17(1):10–18. <https://doi.org/10.1111/eje.12012>
14. Brewer EW, Burgess DN. Professor's role in motivating students to attend class [Internet]. *J Ind Teach Educ.* 2005 [cited 2018 Jan 5];42(3):23–47. Available from: <https://ir.library.illinoisstate.edu/jste/vol42/iss3/3>
15. Han L. Teacher's Role in Developing Learner Autonomy: A Literature Review. *Int J Eng Lang Teach.* 2014;1(2):21–7. <https://doi.org/10.5430/ijelt.v1n2p21>
16. Reinders H, White C. 20 years of autonomy and technology: how far have we come and where to next? [Internet]. *Lang Learn Technol.* 2016 [cited 2018 Jan 5];20(2):143–54. Available from: <http://llt.msu.edu/issues/june2016/reinderswhite.pdf>
17. Núñez JL, Fernández C, León J, Grijalvo F. The relationship between teacher's autonomy support and students' autonomy and vitality. *Teach Teach.* 2015; 21(2):191–202. <https://doi.org/10.1080/13540602.2014.928127>
18. Hyungshim J, Reeve J, Halusic M. A New Autonomy-Supportive Way of Teaching That Increases Conceptual Learning: Teaching in Students' Preferred Ways. *J Exp Educ.* 2016;84(4):686–701. <https://doi.org/10.1080/00220973.2015.1083522>
19. Temiz T. Problem solving, creativity and constructivist-based teaching practice of preservice mathematics teachers [Internet]. *J Educ Instr Stud World.* 2013 [cited 2018 Jan 5];3(1). Available from: [http://www.wjeis.org/FileUpload/ds217232/File/20\\_tugba\\_temiz.pdf](http://www.wjeis.org/FileUpload/ds217232/File/20_tugba_temiz.pdf)
20. Deci EL, Ryan RM. Self-determination theory: A macrotheory of human motivation, development and health. *Can Psychol.* 2008;49(3):182–5. <https://doi.org/10.1037/a0012801>
21. Marandi SS, Sadaghian S. A Shift into Autonomous Education [Internet]. *Journal of English Language Teaching and Learning.* 2016 [cited 2018 Jan 5];17:75–92. Available from: [http://elt.tabrizu.ac.ir/article\\_4961\\_d6d88774bfbcb2866cf2b97f58c8e2038.pdf](http://elt.tabrizu.ac.ir/article_4961_d6d88774bfbcb2866cf2b97f58c8e2038.pdf)
22. Little D. Learning as dialogue: The dependence of learner autonomy on teacher autonomy [Internet]. *System.* 1995 [cited 2018 Jan 5];23(2):175–81. Available from: <http://eprints.teachingandlearning.ie/2753/1/Little%201995.pdf>
23. Cakici D. An Investigation of Learner Autonomy in Turkish EFL Context. *Int J High Educ.* 2017;6(2):89–99. <https://doi.org/10.5430/ijhe.v6n2p89>
24. Gavriyuk OA. Autonomy as a core value of lifelong learning. *Journal of Siberian Federal University. Humanit Soc Sci.* 2015;8(11):2283–90. <https://doi.org/10.17516/1997-1370-2015-8-11-2283-2290>
25. Mohammadi M, Moradi K. Exploring Change in EFL Teachers' Perceptions of Professional Development. *J Teach Educ Sustain.* 2017; 19(1):22–42. <https://doi.org/10.1515/jtes-2017-0002>
26. Aviram A. Beyond constructivism: Autonomy-Oriented Education. *Stud Philos Educ.* 2000;19(5-6):465–89. <https://doi.org/10.1023/A:1005267111741>
27. Dagar V, Yadav A. Constructivism: A Paradigm for Teaching and Learning. *Arts Social Sci J.* 2016;7:200. <https://doi.org/10.4172/2151-6200.1000200>

# LESCH-NYHAN DISEASE: A RARE DISORDER WITH MANY UNRESOLVED ASPECTS

V. Micheli<sup>1,2</sup>, M. Bertelli<sup>3</sup>, G. Jacomelli<sup>1</sup>, A. Santucci<sup>1</sup>, G. Bernardini<sup>1</sup>

<sup>1</sup>Dpt. Biotechnology, Chemistry and Pharmacy, University of Siena, Via A. Moro 2, 53100 Siena, Italy

<sup>2</sup>LND Famiglie Italiane ONLUS, Via Giovanetti 15-20, 16149 Genova, Italy

<sup>3</sup>MAGI non-profit organization, Via delle Maioliche 57/D, 38068 Rovereto (TN) - Italy

## Abstract

Lesch-Nyhan Disease (LND) is a rare X-linked recessive metabolic and neurological syndrome due to the deficiency of hypoxanthine-guanine phosphoribosyltransferase (HPRT). Besides its well known “housekeeping” function this purine salvage enzyme has revealed an unexpected role in neurodevelopment, unveiled by the peculiar neurological symptoms flanking hyperuricemia in LND: dystonia, choreoathetosis, compulsive self-injurious behaviour. Several lines of research have tried to find the molecular basis for the neurological phenotype after the disease was first described in 1964. Dopaminergic deficit was then found to underlie the neurologic symptoms but the aetiology for such alteration seemed inexplicable. A number of detailed studies in the last 50 years addressed the genetic, metabolic, cognitive, behavioral and anatomical features of this disease. Initial investigations sought for accumulation of toxic metabolites or depletion of essential molecules to disclose potential connections between purine recycling and neuronal dysfunction. In the last two decades sophisticated biotechnological methods were used for a deeper insight in the genetic and molecular aspects, unveiling a network of combined gene dysregulations in neuronal development and differentiation producing neurotransmission defects. These studies, conducted with several different approaches, allowed consistent steps forward, demonstrating transcriptional aberrations affecting different metabolic pathways in HPRT deficiency, yet leaving many questions still unsolved.

## Keywords

Lesch-Nyhan disease • neurological syndrome • hyperuricemia • therapies

## Introduction

A “bizarre” metabolic and neurological syndrome, characterized by marked hyperuricemia and hyperuricuria, was identified as an X-linked recessive disease and named “Lesch-Nyhan Disease” (LND) after the two physicians who first described it [1,2]. Later, the biochemical cause was identified as a single enzyme deficiency: hypoxanthine-guanine phosphoribosyltransferase (HPRT; EC 2.4.2.8) [3]. HPRT catalyzes the salvage of the purine bases hypoxanthine and guanine converting them into their respective monophosphate nucleosides (IMP and GMP) by a PRPP-dependent phosphoribosyl transfer reaction (Fig. 1). It is a cytoplasmic enzyme ubiquitously expressed in human tissues, displaying different specific activity in different tissues and during development, with highest activities in testis and brain [4-6]. The human enzyme is encoded by a single structural gene (*HPRT1*) located at Xq26-27. The gene has been sequenced and more than 400 different mutations in the coding region have been described causing different degrees of deficiency [7]. HPRT aminoacid sequence has been determined and various alterations of the physical and kinetic properties of the enzyme have been reported in

patients bearing different mutations [8,9], leading to complete or partial deficiency. In few cases deficiency of HPRT activity in intact cultured fibroblasts was reported not to be related to any mutation in the HPRT coding sequence but to markedly decreased HPRT expression of mRNA [10-12]. In these cases deficiency was attributed to a defect in gene regulation of unknown cause.

Megaloblastic anaemia unresponsive to folate therapy is also common in LND patients [13].

The basic diagnostic criterion for LND and its variants is HPRT activity assay in lysates or intact erythrocytes or fibroblasts; diagnostic suspect can be raised by grossly increased uric acid amount in plasma and urine, accompanied by increased hypoxanthine and xanthine [13].

## Genetic aspects of LND

The prevalence of LND is approximately estimated to be 1/380,000 live births. It appears to occur in all populations

with equal frequency and is the less rare disease among those described for purine metabolism.

Since HPRT deficiency is inherited as a recessive X-linked trait, males are generally affected and women may be asymptomatic carriers. Nevertheless at least five females with complete HPRT deficiency and full LND [14-17] and one with partial deficiency [18] have been reported. In female LND a variety of molecular mechanisms causing the deficiency have been described, affecting the second allele or X-inactivation ratio [16].

### Hyperuricemia in LND

HPRT deficiency, either partial or complete, causes marked overproduction of uric acid with consequent nephrolithiasis, renal failure and juvenile gout. Several mechanisms contribute to uric acid overproduction resulting in hyperuricemia: the ready conversion of unrecycled guanine and hypoxanthine into uric acid by means of guanase and xanthine oxidase (Fig. 1), and the consistent increase of *de novo* purine synthesis. The latter is likely due to raised availability of PRPP and to decreased amounts of IMP, AMP and GMP, feedback inhibitors of phosphoribosylpyrophosphate-amidotransferase (the first and rate-limiting enzyme of *de novo* synthesis, Fig.1) [19]. Elevated adenine phosphoribosyltransferase (APRT; E.C. 2.4.2.7) activity is a common finding and may also contribute to purine overproduction [20].

Hyperuricemia, often leading to renal failure, is a serious problem in LND and its variants. Usual treatment is based on inhibitors of xanthine oxidoreductase (XOR: XDH, E.C. 1.17.1.4; XO, E.C. 1.17.3.22) such as allopurinol and febuxostat, effectively lowering UA, but accumulating hypoxanthine and xanthine. The latter may form stones with frequent renal failure [21,22]; moreover, the increased hypoxanthine and xanthine concentrations occurring in LND cerebrospinal fluid have been related to the neurological manifestation (reviewed below). Despite the use of allopurinol to control hyperuricemia, some patients still succumb to the consequences of persistent nephrolithiasis, such as renal failure or urosepsis. Rasburicase, a recombinant urate oxidase converting uric acid into allantoin, is also sporadically used for rapid prevention of renal failure. Alternative treatments avoiding hypoxanthine accumulation have been recently proposed, based on recombinant enzyme therapy restoring the uricolytic pathway, lost in humans [23], or on upstream PNP inhibition to slower purine breakdown [24].

### Neurological aspects in LND

LND patients present severe neurological and motor disability, and most of them are confined to wheelchair. The

neurological picture, closely resembling athetoid cerebral palsy, encompasses a spectrum of extrapyramidal signs including dystonia, choreoathetosis, dysarthria, dysphagia, opisthotonos, and occasionally ballismus. Some patients also develop pyramidal signs, such as spasticity and hyperreflexia. The most striking aspect of the disease concerns behavioral problems: a peculiar severe sort of compulsive self-injurious behavior is common, with self mutilation (lip, tongue or finger biting), and other occasional different means of self-harm. Self-injury is not the result of a lack of sensation (the patients feel pain and are relieved when protected from themselves) but can be ascribed to an obsessive-compulsive behavior often revealing new and unexpected forms [25] and still under study. Without restrictions, most patients can develop important auto-mutilating lesions [26]. Difficult behaviours such as impulsivity, striking or spitting at others, or use of socially unacceptable language is also rather frequent. Despite their periodic aggressive behavior, LND patients are frequently happy and engaging children when they are restrained. Affected individuals have often been described as cognitively impaired, but such feature is difficult to assess and is often misdiagnosed due to the behavioral disturbances, motor deficits, and attention problems [27]. Individuals with LND usually have a normal prenatal and perinatal course and psychomotor delay may become evident within 3 to 6 months. Self mutilation can appear as soon as teeth are present or later [28,29]. Few patients live beyond 40 years, death occurring due to different causes, including pneumonia and sudden, unexpected death with respiratory origin [30].

Depending on the amount of residual HPRT activity the neurological syndrome can be full-spectrum (LND, virtually no residual activity), or less severe, with mild or no neurological impairment [28]. The term "Lesch-Nyhan variants" has been introduced to describe a continuous spectrum of neurological involvement present in HPRT-deficient patients, with some degree of cognitive impairment, spasticity, dystonia, but without the complete syndrome. It is general opinion that genotype-phenotype correlations are based on HPRT residual activity, the severity of neurological symptoms being inversely proportional to enzyme activity [31-33]. Site-directed mutagenesis and *in vitro* expression of mutant HPRT (44 mutations associated with a wide spectrum of clinical phenotypes) was used to confirm correlation between disease severity and residual catalytic activity of the enzyme [34]. The deficiency of HPRT activity on guanine was described to correlate more strictly with clinical aspects of LND phenotype than that on hypoxanthine, suggesting different direct roles for guanine and hypoxanthine in the pathogenesis [35]. In some cases members of affected families bearing identical mutations have been described to present surprisingly different range of phenotype [36,37].

## Investigations on the pathogenesis of neurological and behavioral alterations in LND

The connection between the neurological syndrome described in LND patients and HPRT deficiency appeared inexplicable: the role of HPRT in purine metabolism was well known and no connection with neurotransmitters was evident. A number of detailed studies in the last decades addressed the genetic, metabolic [25,28,38], cognitive [26,39], behavioral [26,27,40] and anatomical [6,29,41] features of the disease. Initial investigations sought for the possible accumulation of toxic metabolites or depletion of essential molecules to disclose potential connections between purine recycling and neuronal dysfunction. Further on sophisticated methods were used to have a deeper insight in the genetic and molecular aspects, unveiling a network of combined dysregulations in cell development and differentiation producing neurotransmission defects (Fig. 2).

The biochemical aspects of LND were extensively explored in patient cells (erythrocytes, lymphoblasts, fibroblasts), in patient autopsied brain specimens, in different HPRT-deficient cultured cell lines and in animal models. The results are often inconsistent, suggesting significant differences depending upon cell types and tissue source [42]. Several metabolic abnormalities are known to accompany HPRT deficiency, including the above mentioned grossly increased *de novo* purine synthesis. Peculiar features have been reported in erythrocytes, such as GTP depletion, increased UDP-glucose and PRPP concentration [43] (also found in lymphoblasts and fibroblasts) and appreciable levels of ZTP (5-amino-4-imidazole carboxamide ribotide triphosphate), a phosphorylated intermediate of *de novo* synthesis normally undetectable [44,45]. Some enzyme activities have also been reported to be abnormally increased in HPRT-deficient erythrocytes, namely APRT, IMP dehydrogenase (E.C. 1.1.1.205) [20] and cN-II (E.C. 3.1.3.5) [46]. Grossly increased NAD concentration was reported [47,43] with normal or lower NADH/NAD<sup>+</sup> ratio in LND erythrocytes [48]. Increased utilization of exogenous NAD precursor nicotinic acid by intact erythrocytes [49,50], with increased or normal erythrocyte activities of the enzymes committed to its synthesis were reported in LND patients [51, 52], and low NAD glycohydrolase activity [53] (Fig. 1). Decreased activity of PARP (Poly-ADP-ribose polymerase) was found in LND lymphoblasts [54], possibly accounting for the high levels of NAD and also suggesting defective DNA repair mechanisms. By contrast decreased NAD, ATP and GTP concentrations and increased NAD production from nicotinic acid were measured in LND fibroblasts [38]. NAD concentration and related enzyme activities were found to be significantly increased in liver, but not in brain or blood, of

HPRT- knockout mice, animal models of LND [55]. Together these findings suggested that disturbed pyridine metabolism may accompany the purine perturbation associated to HPRT deficiency in different cell types and possibly be involved in LND neurological symptoms.

*Post mortem* studies of brains from LND patients had not disclosed any characteristic morphological abnormality [6, 29]; but later on magnetic resonance imaging (MRI) studies revealed marked and widespread reductions of brain white matter volume [41].

Neurochemical analysis of *post mortem* tissues revealed dysfunction of brain neurotransmitters, with decreased dopaminergic neuron terminals in the striatum and increased amount of serotonin and 5-hydroxyindolacetate [56]. Decreased levels of the dopamine (DA) metabolite homovanillic acid, together with increased hypoxanthine and xanthine concentrations were found in LND patient's cerebrospinal fluid [57]. PET neurochemical and neuroimaging *in vivo* studies performed in LND patients demonstrated significant abnormalities of DA neuron function in the basal ganglia: decreased dopaminergic production and storage [58] and decreased binding to dopamine transporters [59], that might account for the abnormal extrapyramidal neurological signs and many behavioral anomalies. Nevertheless, the widespread reductions of brain white matter volume reported above [41] could reflect abnormalities of brain connectivity, pointing at the involvement of pathways beyond the basal ganglia.

## Investigations on the pathogenesis of neurological and behavioral alterations in LND: animal and cell models of LND

Two animal models have been developed and employed in the study of LND pathogenesis. A pharmacological model, the 6-hydroxydopamine-treated rat, in which catecholamine-containing neurons were destroyed, showed self-injurious behavior in response to DOPA-agonist administration, supporting the connection between self-injurious behaviour and DA deficit [60]. The already mentioned genetic model (the HPRT-knockout mouse) [55] did not show neurobehavioral alterations but presented an age-related decreased content of DA in the brain [61].

Various HPRT-deficient cell cultures were developed to study the effects of the enzyme deficit and of purine alterations [62, 63, 64] and confirmed DA deficit. Since HPRT has no direct relationships with the dopaminergic pathways, the mechanisms whereby its deficiency affects them appeared inexplicable [62,65]. Variations in other neurotransmitter systems have also been implicated in patients with LND and in animal models of the disease, such as serotonin [62, 66] and adenosine neurotransmitter systems [67,68].

### Investigations on the pathogenesis of neurological and behavioral alterations in LND: role of hypoxanthine

Hypoxanthine excess is a prominent biochemical feature described in the central nervous system of LND patients, and its role has been extensively investigated. Hypoxanthine has been reported to alter adenosine transport [68] and to decrease sensitivity at the post-synaptic DA receptors [69]. Studies conducted in LND peripheral blood lymphocytes exposed to hypoxanthine revealed increased expression of DRD5 dopamine receptor, variably aberrant expression of ADORA2A adenosine receptor and decreased expression and protein level of 5-HT1A serotonin receptor. This would support the hypothesis that the pathogenesis of neurological manifestations of LND patients may be related to an imbalance of neurotransmitters, rather than to the isolated disturbance of one of them. In fact, adenosine, DA and serotonin receptors, belonging to the G-protein-coupled superfamily, seem to be integrated through intermembrane receptor–receptor interactions [70,71]. Hypoxanthine excess has also been reported to alter Na<sup>+</sup>/K<sup>+</sup> ATPase activity [72] in isolated cells, thus suggesting its implication in the pathogenesis of the neurological dysfunction. Implication of hypoxanthine in the morphogenesis impairment and proliferation enhancement in cultured HPRT deficient neuroblastoma cells, a neuronal model of LND, has also been proposed [73]. Intrastratial hypoxanthine administration to 60-day-old rats altered neuroenergetic parameters, resulting in ATP depletion and mitochondrial dysfunction and cell death by apoptosis, suggesting that these processes may be associated, at least in part, with neurological symptoms found in LND patients [74].

Deficit of other purine compounds due to HPRT defect is controversial, and altered nucleotide concentrations have been postulated as a possible cause of changes in G-protein-mediated signal transduction [75]. This hypothesis was supported by the finding of changes in the expression and function of adenylate cyclase C isoform as a result of HPRT deficiency in B103 neuroblastoma cells [76]. Another line of research hypothesized that GTP depletion in HPRT deficiency may affect tetrahydrobiopterin (BH<sub>4</sub>) synthesis through GTP cyclohydrolase, but BH<sub>4</sub> limitation was not demonstrated to be responsible for the dopamine loss in patients or animal models [77].

### Investigations on the pathogenesis of neurological and behavioral alterations in LND: gene transcription and expression aberrations

Transcriptional aberrations in a number of genes were described in the HPRT knockout mice, suggesting a role of

genes other than HPRT in the HPRT-deficiency phenotype. In this hypothesis HPRT deficiency would induce secondary transcriptional aberrations in other genes, that could play an important role in the development of some aspects of the HPRT-deficiency phenotype, especially the neurological deficits [78]. Such hypothesis was confirmed by several studies conducted in the last decade in HPRT-deficient cell models [79,80] and in HPRT-deficient human neural stem cells [81]. Aberrant expression of several vital transcription factors involved in DA-neuron development and in pan-neuronal differentiation has been demonstrated in cultured HPRT-deficient human teratocarcinoma NT cells (NT2). Such studies provided direct experimental evidence for aberrant neurogenesis in HPRT deficiency and suggested impaired upregulation of tyrosine hydroxylase (TH, the rate-limiting enzyme in DA production) and of aromatic L-amino-acid decarboxylase, the final step in DA synthesis [79]. Investigations conducted by microarray and quantitative PCR in 10 different HPRT-deficient mouse cell sublines also demonstrated that HPRT deficiency influences early developmental processes controlling the dopaminergic phenotype by increasing transcription factors which play a key role in the specification and survival of DA neurons [80]. Altered expression of several transcription factors and DA markers was found in human neural stem cells (hNSCs) isolated from human LND fetal brain, providing direct experimental evidence for aberrant neurogenesis [82]. Studies in SH-SY5Y neuroblastoma cells made HPRT-deficient by shRNA revealed broad pleiotropic neuro-regulatory defects, demonstrating dysregulated Wnt signaling and presenilin-1 expression together with impaired expression of dopaminergic transcription factors [83]. Other authors found that hypoxanthine excess influences the Wnt/β-catenin pathway by both increasing WNT11 and WNT4 expression and reinforcing the WNT4 and EN1 expression induced by retinoic acid in NT2/D1 cells, thus deregulating early neuronal differentiation [84]. Aberrant over-expression of miR181a was found in HPRT-deficient human dopaminergic SH-SY5Y neuroblastoma cells, which significantly reduced endogenous expression of genes known to be required for neural development, including EN1, EN2, LMX1a and BRN2, and suggested that miRNAs may play a role in the pathogenesis of LND [85]. Dysregulated microRNAs from the miR-17 family cluster and guanine-based cellular functions were found in differentiating HPRT-deficient human neuron-like cell lines by microRNA array and gene ontology analysis. In the same study, dysregulated expression of exchange protein activated by cAMP (EPAC) in the cortex, the midbrain and the striatum of HPRT ko mice and in HPRT-deficient human neuron-like cell lines and fibroblast cells from LND patients were found, and also a marked impairment in the activation of small GTPases. Collectively these aberrations were hypothesized to contribute to the complex LND neurological phenotype [86]. Another



line of research demonstrated that HPRT-deficient neuronal cell lines have reduced CREB (cAMP response element-binding protein) expression and lower intracellular cyclic AMP (cAMP), which correlates with attenuated CREB-dependent transcriptional activity and reduced phosphorylation of protein kinase A (PKA) substrates such as synapsin (p-syn I). Increased expression of phosphodiesterase 10A (PDE10A) was also found and the overall conclusion was that HPRT-deficiency alters cAMP/PKA signaling pathway [87].

The mechanisms by which HPRT deficiency influences the expression of different genes and leads to transcriptional aberrations might be direct or indirect, the latter following the changes in purine metabolism when HPRT is missing. A general problem in the field of LND research concerns the selection of a suitable model system. Indeed, disruption of purine levels is known to have an important influence on neuronal differentiation [81]. Purine pools and their metabolism were examined in rat PC6-3 cells, a PC12 pheochromocytoma subclone. The loss of HPRT-mediated purine recycling is associated with significant loss of dopamine and related metabolites in the HPRT mutant PC6-3 lines, suggesting an important connection between purine and dopamine pathways [88].

HPRT-deficient pluripotent human stem cells induced by shRNA targeted to the *HPRT* gene showed aberrant purinergic signaling occurring at least partly through aberrant P2Y1-mediated expression and signaling. Such mechanisms may play a role in the neuropathology of HPRT-deficiency LND [89]. A proteomic approach revealed changes in protein expression in HPRT-deficient dopaminergic rat PC6-3 line, before and after differentiation with nerve growth factor, with an unexpectedly broad influence on many biochemical pathways (neurotransmission, protein synthesis and metabolism, mitochondrial function, single methyl donor pathways involving SAM or folate) possibly related to the cell cycle [90]. Transcriptomics studies conducted on LND fibroblasts and on induced pluripotent stem cells (iPS) by microarray based methods together with qPCR also revealed that HPRT deficiency is accompanied by perturbations in specific processes. Twenty-five transcripts were found with significantly altered expression level that are involved in specific processes known to regulate cell cycle and cell-division, metabolic and nucleic acid processes [91]. Global transcriptomic analyses confirmed that several mechanisms are severely affected during neuronal differentiation of HPRT-deficient murine ESD3 embryonic stem cells: beside large number of developmental and cell signaling pathways regulating CNS development, most particularly mechanisms that determine neuronal/glia cell fate decisions during neurogenesis were altered, with a major transcriptional switch away from neuronal almost entirely to a glial gene expression program, though with at least some of the principal molecular properties of dopaminergic neurons [92].

A role for the amyloid precursor protein (APP) has been suggested in the development of LND epigenetic modifications, due to gene-gene interactions (epistasis) between mutated HPRT and APP genes, which could affect the regulation of alternative APP pre-mRNA splicing in favor of APP isoforms responsible for the disease, though no experimental evidence at present proven the direct link between LND and APP [93].

Many combined results deriving from such many different approaches seem to indicate that the housekeeping gene HPRT is a vital neurodevelopmental gene and that it plays a number of important non-“housekeeping” functions in some pathways of mammalian neurogenesis. In summary, various studies have led to understand that the neurological symptoms of LND are related to a dysfunction of the dopaminergic neurotransmitter system in the basal ganglia, and possibly extended beyond this area. The great bulk of recent observations shed a new light on the mysterious relationship between the dopamine deficit and the purine metabolic disorder, though the final step is still lacking.

## Therapy

The lack of precise understanding of the neurological dysfunction in LNS has precluded development of specific therapies, though several attempts have been made in different directions. Treatment with allopurinol has no effect on the neurologic or behavioural manifestations of the disease [62].

Following the hypothesis that deficiency of IMP and GMP might be the cause for LND, treatment with adenine (readily transported and converted to AMP, which in turn can be converted to IMP by AMP deaminase) was tried without effect [94] as well as treatment with AICA or AICAR expected to raise nucleotide levels [95]. Actually no specific decrease in purine level was found in any model studied.

Many pharmaceutical treatments, often useful, but never resolving (e.g.: benzodiazepines, carbamazepines and gamma-aminobutyric acid inhibitors, gabapentin, dopamine replacement) often leading to inconsistent outcomes have been reported and reviewed [29, 13, 96]. Limited studies have been conducted on S-adenosylmethionine (SAM) as a medication for LND with contradictory but promising findings, at least offering an additional therapeutic means to current symptomatic therapy [97- 100].

Dopamine neurons likely fail to mature properly, which is consistent with several gene expression studies of HPRT-cell models showing disruption of molecular pathways for dopamine neuron development. Thus, the loss of dopamine or TH seems to reflect an aspect of a broader developmental defect in these neurons, and restoration of dopamine alone seems insufficient [101, 102].



Therapeutic efforts have often mainly focused on symptom control. Intrathecal baclofen therapy ameliorated the motor and behavioral symptoms [103].

Good results have been obtained by chronic deep brain stimulation of the globus pallidus which may be a promising method to treat self-mutilating behavior and dystonia associated with LND [104-107].

Attempts to develop gene therapy have also been made [108] but could not be applied in patients.

An enzyme replacement approach by TAT transduction domain and by liposome mediated protein transfer into HPRT deficient leukemia T-cells (CEM/HPRT) was also reported in an in vitro study [109].

## Conclusion

The present review aimed to highlight the great deal of research moved by LND, a rare disease displaying many puzzling aspects. First of all, the connection between the deficiency of HPRT activity and the neurological syndrome: no direct link exists between this enzyme and the dopaminergic transmission which has been demonstrated to be impaired, and several molecular pathways are likely involved as a pathogenetic cause. Nevertheless the intimate mechanism is not clear yet. Another unresolved problem is the finding of different phenotypes in patients bearing the

same genetic mutation, which pointed at the involvement of epigenetic mechanisms. On the whole many studies led to the conclusion that the consequences of HPRT deficiency are far beyond the metabolic function of this enzyme, and that the pathogenesis of this monogenic but yet very complex neurodevelopmental disease results from combinatorial and multigenic defects.

Resolutive therapy is the main goal of overall research: the understanding of times and modes of neurological lesion occurrence would suggest times and modes of clinical intervention. The common belief is that any therapeutic action should be very early; times for effective intervention (e.g. dopamine restoration) must be ascertained and new therapeutic molecules investigated. In the meantime symptomatic therapies providing some relief from the invalidating disturbances of LND are under clinical trial.

Research is in continuous progress and accurate reviewing is necessary for frequent update and for an overall vision allowing a deeper insight in the disease.

## Conflict of Interest Statement

V. Micheli, M. Bertelli, G. Jacomelli, A. Santucci, G. Bernardini declare that the submitted work was not carried out in the presence of any personal, professional or financial relationship that could potentially be construed as a conflict of interest.

## References

1. Lesch M, Nyhan WL. A familial disorder of uric acid metabolism and central nervous system function. *Am J Med.* 1964;36:561–70.
2. Nyhan W, Pesek J, Sweetman L, Carpenter D, Carter C. Genetics of an X-linked disorder of uric acid metabolism and cerebral function. *Pediatric Res.* 1967;1:5–13.
3. Kelley WN, Rosenbloom FM, Henderson JF, Seegmiller JE. A specific enzyme defect in gout associated with overproduction of uric acid. *Proc Natl Acad Sci.* 1967;57(6):1735–9.
4. Kelley WN, Greene ML, Rosenbloom FM, Henderson JF, Seegmiller JE. Hypoxanthine-guanine phosphoribosyltransferase deficiency in gout. *Ann Intern Med.* 1969; 70(1):155–206.
5. Adams A, Harkness RA. Developmental changes in purine phosphoribosyltransferases in human and rat tissues. *Biochem J.* 1976;160(3):565–76.
6. Watts RW, Spellacy E, Gibbs DA, Allsop J, McKeran RO, Slavin GE. Clinical, post-mortem, biochemical and therapeutic observations on the Lesch-Nyhan syndrome with particular reference to the neurological manifestations. *Q J Med.* 1982;51(201):43–78.
7. Jinnah HA, De Gregorio L, Harris JC, Nyhan WL, O'Neill JP. The spectrum of inherited mutations causing HPRT deficiency: 75 new cases and a review of 196 previously reported cases. *Mutat Res.* 2000;463(3):309–26.
8. Wilson JM, Baugher BW, Landa L, Kelley WN. Human hypoxanthine-guanine phosphoribosyltransferase - purification and characterization of mutant forms of the enzyme. *J Biol Chem.* 1981;256(20):306–12.
9. Zoref-Shani E, Feinstein S, Frishberg Y, Bromberg Y, Sperling O. Kelley-Seegmiller syndrome due to a unique variant of hypoxanthine-guanine phosphoribosyltransferase: reduced affinity for 5-phosphoribosyl-1-pyrophosphate manifested only at low, physiological substrate concentrations. *Biochem biophys Acta.* 2000;1500(2):197–203.
10. Dawson PA, Gordon RB, Keough DT, Emmerson BT. Normal HPRT coding region in a male with gout due to HPRT deficiency. *Mol Genet Metab.* 2005;85(1):78–80. <https://doi.org/10.1016/j.ymgme.2005.01.005>

11. Garcia MG, Torres RJ, Puig JG. Methylation status of HPRT promoter in HPRT deficiency with normal coding region. *Nucleosides Nucleotides Nucleic Acids*. 2010;29(4-6):301–5. <https://doi.org/10.1080/15257771003738675>
12. Nguyen KV, Naviaux RK, Paik KK, Nyhan WL. Lesch–Nyhan Syndrome: mRNA expression of HPRT in patients with enzyme proven deficiency of HPRT and normal HPRT coding region of the DNA. *Mol Gen Metab*. 2012;106(4):498–501. <https://doi.org/10.1016/j.ymgme.2012.06.003>
13. Torres RJ, Puig JG. Hypoxanthine-guanine phosphoribosyltransferase (HPRT) deficiency: Lesch-Nyhan syndrome. *Orphanet J Rare Dis*. 2007;2:48. <https://doi.org/10.1186/1750-1172-2-48>
14. De Gregorio L, Jinnah HA, Harris JC, Nyhan WL, Schretlen DJ, Trombley LM, et al. Lesch–Nyhan disease in a female with a clinically normal monozygotic twin. *Mol Genet Metab*. 2005;85(1):70–7. <https://doi.org/10.1016/j.ymgme.2004.11.009>
15. Aral B, de Saint Basile G, Al-Garawi S, Kamoun P, Ceballos-Picot I. Novel nonsense mutation in the hypoxanthine guanine phosphoribosyltransferase gene and nonrandom X-inactivation causing Lesch–Nyhan syndrome in a female patient. *Hum Mutat*. 1996;7(1):52–8.
16. Rinat C, Zoref-Shani E, Ben-Neriah Z, Bromberg Y, Becker-Cohen R, Feinstein S, et al. Molecular, biochemical, and genetic characterization of a female patient with Lesch-Nyhan disease. *Mol Genet Metab*. 2006; 87(3):249–52. <https://doi.org/10.1016/j.ymgme.2005.09.025>
17. Ogasawara N, Stout JT, Goto H, Sonta S, Matsumoto A, Caskey CT. Molecular Analysis of a Female Lesch-Nyhan Patient. *J Clin Invest*. 1989;84(3):1024–7. <https://doi.org/10.1172/JCI114224>
18. Sebesta I, Stiburkova B, Dvorakova L, Hrebicek M, Minks J, Stolnaja L, et al. Unusual presentation of Kelley-Seegmiller syndrome. *Nucleosides Nucleotides Nucleic Acids*. 2008;27(6):648–55. <https://doi.org/10.1080/15257770802143863>
19. Holmes EW, McDonald JA, McCord JM, Wyngaarden JB, Kelley WN. Human glutamine phosphoribosylpyrophosphate amidotransferase. Kinetic and regulation properties. *J Biol Chem*. 1973;248(1):144–50.
20. Wilson JM, Daddona PE, Otoadese T, Kelley WN. Adenine phosphoribosyltransferase in patients with disorders of purine and pyrimidine metabolism. *J Lab Clin Med*. 1982;99(2):163–74.
21. Torres RJ, Prior C, Puig JG. Efficacy and safety of allopurinol in patients with hypoxanthine-guanine phosphoribosyltransferase deficiency. *Metabolism*. 2007;56(9):1179–86. <https://doi.org/10.1016/j.metabol.2007.04.013>
22. Terkeltaub R, Bushinsky DA, Becker MA. Recent developments in our understanding of the renal basis of hyperuricemia and the development of novel antihyperuricemic therapeutics. *Arthritis Res Ther*. 2006;8 Suppl 1:S4. <https://doi.org/10.1186/ar1909>
23. Ronda L, Marchetti M, Piano R, Liuzzi A, Corsini R, Percudani R, et al. A trivalent enzymatic system for uricolytic therapy of HPRT deficiency and Lesch-Nyhan disease. *Pharm Res*. 2017;34(7):1477–90. <https://doi.org/10.1007/s11095-017-2167-6>
24. Jacomelli G, Baldini E, Mugnaini C, Micheli V, Bernardini G, Santucci A. Inhibiting PNP for the therapy of hyperuricemia in Lesch-Nyhan disease: preliminary in vitro studies with analogues of Im-mucillin-G. *J Inher Metab Dis*. 2018 Jun 4. <https://doi.org/10.1007/s10545-018-0196-x> [Epub ahead of print].
25. Puig JG, Torres RJ, Mateos FA, Ramos TH, Arcas JM, Buno AS, et al. The spectrum of hypoxanthine-guanine phosphoribosyltransferase (HPRT) deficiency. Clinical experience based on 22 patients from 18 Spanish families. *Medicine*. 2001;80(2):102–12.
26. Anderson LT, Ernst M. Self-injury in Lesch-Nyhan disease. *J Autism Dev Disord*. 1994;24(1):67–81.
27. Schretlen DJ, Ward J, Meyer SM, Yun J, Puig JG, Nyhan WL, et al. Behavioral aspects of Lesch-Nyhan disease and its variants. *Dev Med Child Neurol*. 2005;47(10):673–77.
28. Jinnah HA, Friedmann T. Lesch–Nyhan disease and its variants. In: Scriver CR, Beaudet AL, Sly WS, Valle D, eds. *The Online Metabolic and Molecular Bases of Inherited Disease*. New York: McGraw-Hill; 2000. p. 2537–70. <https://doi.org/10.1036/ommbid.135>
29. Jinnah HA, Visser JE, Harris JC, Verdu A, Larovere L, Ceballos-Picot I, et al. Delineation of the motor disorder of Lesch–Nyhan disease. *Brain*. 2006;129(Pt5):1201–17. <https://doi.org/10.1093/brain/awl056>
30. Neychev VK, Jinnah HA. Sudden death in Lesch-Nyhan disease. *Dev Med Child Neurol*. 2006; 48(11):923–6.
31. Jinnah HA, Ceballos-Picot I, Torres RJ, Visser JE, Schretlen DJ, Verdu A, et al. Attenuated variants of Lesch-Nyhan disease. *Brain*. 2010;133(3):671–89. <https://doi.org/10.1093/brain/awq013>
32. Fu R, Jinnah HA. Genotype-Phenotype Correlations in Lesch-Nyhan Disease. Moving beyond the gene. *J Biol Chem*. 2012;287(5):2997–3008. <https://doi.org/10.1074/jbc.M111.317701>
33. Torres RJ, Puig JG, Jinnah HA. Update on the phenotypic spectrum of Lesch-Nyhan disease and its attenuated variants. *Curr Rheumatol Rep*. 2012;14(2):189–94. <https://doi.org/10.1007/s11926-011-0231-5>
34. Fu R, Sutcliffe D, Zhao H, Huang X, Schretlen DJ, Benkovic S, et al. Clinical severity in Lesch-Nyhan disease: the role of residual enzyme and compensatory pathways. *Mol Genet Metab*. 2015;114(1): 55–61. <https://doi.org/10.1016/j.ymgme.2014.11.001>
35. Schretlen DJ, Callon W, Ward RE, Fu R, Ho T, Gordon B, et al. Do clinical features of LND correlate more closely with hypoxanthine or guanine recycling? *Inher Metab Dis*. 2016;39(1):85–91. <https://doi.org/10.1007/s10545-015-9869-x>
36. Hladnik U, Nyhan WL, Bertelli M. Variable expression of HPRT deficiency in 5 members of a family with the same mutation. *Arch Neurol*. 2008;65(9):1240–3. <https://doi.org/10.1001/archneur.65.9.1240>
37. Ceballos-Picot I, Augé F, Fu R, Olivier-Bandini A, Cahu J, Chabrol B, et al. Phenotypic variation among seven members of one family with deficiency of hypoxanthine-guanine phosphoribosyltransferase. *Mol Genet Metab*. 2013;110(3):268–74. <https://doi.org/10.1016/j.ymgme.2013.08.016>

38. Fairbanks LD, Jacomelli G, Micheli V, Slade T, Simmonds HA. Severe pyridine nucleotide depletion in fibroblasts from Lesch-Nyhan patients. *Biochem J*. 2002;366(Pt1):265–72. <https://doi.org/10.1042/bj20020148>
39. Matthews WS, Solan A, Barabas G, Robey K. Cognitive functioning in Lesch-Nyhan syndrome: a 4-year follow-up study. *Dev Med Child Neurol*. 1999;41(4):260–2.
40. Robey KL, Reck JF, Giacomini KD, Barabas G, Eddy GE. Modes and patterns of self-mutilation in persons with Lesch-Nyhan disease. *Dev Med Child Neurol*. 2003;45(3):167–71.
41. Schretlen DJ, Varvaris M, Vannorsdall TD, Gordon B, Harris JC, Jinnah HA. Brain white matter volume abnormalities in Lesch-Nyhan disease and its variants. *Neurology*. 2015;84(2):190–6. <https://doi.org/0.1212/WNL.0000000000001128>
42. Shirley TL, Lewers JC, Egami K, Majumdar A, Kelly M, Ceballos-Picot I, et al. A human neuronal tissue culture model for Lesch-Nyhan disease. *J Neurochem*. 2007;101(3):841–53. <https://doi.org/10.1111/j.1471-4159.2007.04472.x>
43. Simmonds HA, Fairbanks LD, Morris GS, Webster DR, Harley EH. Altered erythrocyte nucleotide patterns are characteristic of inherited disorders of purine or pyrimidine metabolism. *Clin Chim Acta*. 1988;171(2-3):197–210.
44. Sidi Y, Mitchell BS. Z-nucleotide accumulation in erythrocytes from Lesch-Nyhan patients. *J Clin Invest*. 1985;76(6):2416–9.
45. López JM. Is ZMP the toxic metabolite in Lesch-Nyhan disease? *Med Hypotheses*. 2008;71(5):657–63. <https://doi.org/10.1016/j.mehy.2008.06.033>
46. Pesi R, Micheli V, Jacomelli G, Peruzzi L, Camici M., Garcia-Gil M, et al. Cytosolic 5'-nucleotidase hyperactivity in erythrocytes of Lesch-Nyhan syndrome patients. *Neuroreport*. 2000;11(9):1827–31.
47. Simmonds HA, Webster DR, Wilson J, Lingam S. An X-linked syndrome characterized by hyperuricemia, deafness, and neurodevelopmental abnormalities. *Lancet*. 1982;10:68–70.
48. Micheli V, Simmonds HA, Bari M, Pompucci G. HPLC determination of oxidized and reduced pyridine coenzymes in human erythrocytes. *Clin Chim Acta*. 1993;220(1):1–17.
49. Micheli V, Simmonds HA, Ricci C. Regulation of nicotinamide-adenine dinucleotide synthesis in erythrocytes of patients with hypoxanthine-guanine phosphoribosyltransferase deficiency and a patient with phosphoribosylpyrophosphate synthetase superactivity. *Clin Sci*. 1990;78(2):239–45.
50. Micheli V, Sestini S, Rocchigiani M, Jacomelli G, Manzoni F, Peruzzi L, et al. Hypoxanthine-guanine phosphoribosyltransferase deficiency and erythrocyte synthesis of pyridine coenzymes. *Life Sci*. 1999;64(26):2479–87.
51. Micheli V, Gathof B, Rocchigiani M, Jacomelli G, Sestini S, Peruzzi L, et al. Biochemical and molecular study of mentally retarded patient with partial deficiency of hypoxanthine - guanine phosphoribosyltransferase. *Biochim Biophys Acta*. 2002;1587(1):45–52.
52. Sestini S, Pescaglioni M, Magagnoli C, Jacomelli G, Simmonds HA. NAD synthesis in human erythrocytes: study on adenylyltransferase activities in patients bearing purine enzyme disorders. *Adv Exper Med Biol*. 1991;309B:319–22.
53. Cerboni B, Micheli V, Jacomelli G, Notarantonio L, Pompucci G, Sestini S. Erythrocyte NAD glycohydrolase activity in Lesch-Nyhan patients. *Ital J Biochem*. 2007;56:161.
54. McCreanor GM, Harkness RA. Lesch-Nyhan syndrome and its pathogenesis: normal nicotinamide-adenine dinucleotide but reduced ATP concentrations that correlate with reduced poly(ADP-ribose) synthetase activity in HPRT-deficient lymphoblasts. *J Inher Metab Dis*. 1995;18(6):737–47.
55. Micheli V, Jacomelli G, Di Marcello F, Notarantonio L, Sestini S, Cerboni B, et al. NAD metabolism in HPRT-deficient mice. *Metab Brain Dis*. 2009;24(2):311–9. <https://doi.org/10.1007/s11011-009-9134-9>
56. Lloyd KG, Hornykiewicz O, Davidson L, Shannak K, Farley I, Goldstein M, et al. Biochemical evidence of dysfunction of brain neurotransmitters in the Lesch-Nyhan syndrome. *N Engl J Med*. 1981;305(19):1106–11. <https://doi.org/10.1056/NEJM198111053051902>
57. Jankovic J, Caskey CT, Stout JT, Butler IJ. Lesch Nyhan syndrome: a study of motor behavior and cerebrospinal fluid neurotransmitters. *Ann Neurol*. 1988;23(5):466–9. <https://doi.org/10.1002/ana.410230507>
58. Ernst M, Zametkin AJ, Matochik JA, Pascualvaca D, Jons PH, Hardy K, et al. Presynaptic dopaminergic deficits in Lesch-Nyhan disease. *N Engl J Med*. 1996;334(24):1568–72. <https://doi.org/10.1056/NEJM199606133342403>
59. Wong DF, Harris JC, Naidu S, Yokoi F, Marengo S, Dannals RF, et al. Dopamine transporters are markedly reduced in Lesch-Nyhan disease in vivo. *Proc Natl Acad Sci USA*. 1996;93(11):5539–43.
60. Criswell H, Mueller RA, Breese GR. Assessment of purine-dopamine interactions in 6-hydroxydopamine-lesioned rats: evidence for pre- and postsynaptic influences by adenosine. *J Pharmacol Exp Ther*. 1988;244(2):493–500.
61. Jinnah HA, Jones MD, Wojcik BE, Rothstein JD, Hess EJ, Friedmann T, et al. Influence of age and strain on striatal dopamine loss in a genetic mouse model of Lesch-Nyhan disease. *J Neurochem*. 1999;72(1):225–9.
62. Nyhan WL. Dopamine function in Lesch-Nyhan disease. *Environ Health Perspect*. 2000;108(Suppl 3):409–11. <https://doi.org/10.1289/ehp.00108s3409>
63. Smith DW, Friedmann T. Characterization of the dopamine defect in primary cultures of dopaminergic neurons from hypoxanthine phosphoribosyltransferase knockout mice. *Mol Ther*. 2000;1(5 Pt1):486–91. <https://doi.org/10.1006/mthe.2000.0057>
64. Zoref-Shani E, Boer P, Brosh S, Pelled D, Bromberg Y, Sperling O. Purine nucleotide metabolism in cultured neurons and astroglia from HPRT-deficient knockout mice. *Ital J Biochem*. 2001;50(1-2):9–13.
65. Visser JE, Bar PR, Jinnah HA. Lesch-Nyhan disease and the basal ganglia. *Brain Res Brain Res Rev*. 2000;32(2-3):449–75.
66. Bertelli M, Alushi B, Veicsteinas A, Jinnah HA, Micheli V. Study of gene expression and mRNA editing of serotonin receptor 2C in brains of HPRT knock-out mice: animal model of Lesch-

- Nyhan disease. *J Clin Neurosci*. 2009;16(8):1061–3. <https://doi.org/10.1016/j.jocn.2008.12.011>
67. Bertelli M, Cecchin S, Lapucci C, Jacomelli G, Jinnah HA, Pandolfo M, et al. Study of the adenosinergic system in the brain of HPRT knockout mouse (Lesch–Nyhan disease). *Clin Chim Acta*. 2006;373(1-2):104–7. <https://doi.org/10.1016/j.cca.2006.05.013>
68. Prior C, Torres RJ, Puig JG. Hypoxanthine decreases equilibrative type of adenosine transport in lymphocytes from Lesch-Nyhan patients. *Eur J Clin Invest*. 2007;37(11):905–11. <https://doi.org/10.1111/j.1365-2362.2007.01869.x>
69. Palmour RM, Heshka TW, Ervin FR Hypoxanthine accumulation and dopamine depletion in Lesch-Nyhan disease. *Adv Exp Med Biol*. 1989;253A:165–72.
70. García MG, Puig JG, Torres RJ. Adenosine, dopamine and serotonin receptors imbalance in lymphocytes of Lesch-Nyhan patients. *J Inherit Metab Dis*. 2012;35(6):1129–35. <https://doi.org/10.1007/s10545-012-9470-5>
71. Torres RJ, Prior C, Garcia MG, Puig JG. A review of the implication of hypoxanthine excess in the physiopathology of Lesch-Nyhan disease. *Nucleosides Nucleotides Nucleic Acids*. 2016;35(10-12):507–16. <https://doi.org/10.1080/15257770.2016.1147579>
72. Bavaresco CS, Chiarani F, Wannmacher CM, Netto CA, Wyse AT. Intrastratial hypoxanthine reduces Na<sup>+</sup>, K<sup>+</sup>-ATPase activity and induces oxidative stress in the rats. *Metab Brain Dis*. 2007;22(1):1–11. <https://doi.org/10.1007/s11011-006-9037-y>
73. Ma MH, Stacey NC, Connolly GP. Hypoxanthine impairs morphogenesis and enhances proliferation of a neuroblastoma model of Lesch Nyhan syndrome. *J Neurosci Res*. 2001;63(6):500–8. <https://doi.org/10.1002/jnr.1044>
74. Biasibetti-Brendler H, Schmitz F, Pierozan P, Zanutto BS, Prezzi CA, Binkowski de Andrade R, et al. Hypoxanthine induces neuroenergetic impairment and cell death in striatum of young adult wistar rats. *Mol Neurobiol*. 2018;55(5):4098–106. <https://doi.org/10.1007/s12035-017-0634-z>
75. Pinto CS, Seifert R. Decreased GTP-stimulated adenylyl cyclase activity in HPRT-deficient human and mouse fibroblast and rat B103 neuroblastoma cell membranes. *J Neurochem*. 2006;96(2):454–9. <https://doi.org/10.1111/j.1471-4159.2005.03570.x>
76. Kinast L, von der Ohe J, Burhenne H, Seifert R. Impairment of adenylyl cyclase 2 function and expression in hypoxanthine phosphoribosyltransferase-deficient rat B103 neuroblastoma cells as model for Lesch–Nyhan disease: BODIPY–forskolin as pharmacological tool. *Naunyn-Schmiedeberg's Arch Pharmacol*. 2012;385(7):671–83. <https://doi.org/10.1007/s00210-012-0759-6>
77. Hyland K, Kasim S, Egami K, Arnold LA, Jinnah HA. Tetrahydrobiopterin deficiency and dopamine loss in a genetic mouse model of LN disease. *J Inherit Metab Dis*. 2004;27(2):165–78. <https://doi.org/10.1023/B:BOLI.0000028728.93113.4d>
78. Song S, Friedman T. Tissue-specific aberrations of gene expression in HPRT-deficient mice: functional complexity in a monogenic disease? *Mol Ther*. 2007;15(8):1432–43. <https://doi.org/10.1038/sj.mt.6300199>
79. Guibinga GH, Hsu S, Friedmann T. Deficiency of the housekeeping gene hypoxanthine-guanine phosphoribosyltransferase (HPRT) dysregulates neurogenesis. *Mol Ther*. 2010;18(1):54–62. <https://doi.org/10.1038/mt.2009.178>
80. Ceballos-Picot I, Mockel L, Potier MC, Dauphinot L, Shirley TL, Toro-Ibad R, et al. Hypoxanthine-guanine phosphoribosyl transferase regulates early developmental programming of dopamine neurons: implications for Lesch-Nyhan disease pathogenesis. *Hum Mol Genet*. 2009;18(13):2317–27. <https://doi.org/10.1093/hmg/ddp164>
81. Messina E, Micheli V, Giacomello A. Guanine nucleotide depletion induces differentiation and aberrant neurite outgrowth in human dopaminergic neuroblastoma lines: a model for basal ganglia dysfunction in Lesch-Nyhan disease. *Neurosci Lett*. 2005;375(2):97–100. <https://doi.org/10.1016/j.neulet.2004.10.076>
82. Cristini S, Navone S, Canzi L, Acerbi F, Ciusani E, Hladnik U, et al. Human neural stem cells: a model system for the study of Lesch-Nyhan disease neurological aspects. *Hum Mol Genet*. 2010;19(10):1939–50. <https://doi.org/10.1093/hmg/ddq072>
83. Kang TH, Guibinga GH, Jinnah HA, Friedmann T. HPRT deficiency coordinately dysregulates canonical Wnt and presenilin-1 signaling: a neuro-developmental regulatory role for a housekeeping gene? *PLoS One*. 2011;6(1):e16572. <https://doi.org/10.1371/journal.pone.0016572>
84. Torres RJ, Puig JG. Hypoxanthine deregulates genes involved in early neuronal development. Implications in Lesch-Nyhan disease pathogenesis. *J Inherit Metab Dis*. 2015;38(6):1109–18. <https://doi.org/10.1007/s10545-015-9854-4>
85. Guibinga GH, Hrutanovic G, Bouic K, Jinnah HA, Friedmann T. MicroRNA-mediated dysregulation of neural developmental genes in HPRT deficiency: clues for Lesch-Nyhan disease? *Hum Mol Genet*. 2012;21(3):609–22. <https://doi.org/10.1093/hmg/ddr495>
86. Guibinga GH, Murray F, Barron N, Pandori W, Hrutanovic G. Deficiency of the purine metabolic gene HPRT dysregulates microRNA-17 family cluster and guanine-based cellular functions: a role for EPAC in Lesch-Nyhan syndrome. *Hum Mol Genet*. 2013;22(22):4502–15. <https://doi.org/10.1093/hmg/ddt298>
87. Guibinga GH, Murray F, Barron N. HPRT-deficiency dysregulates cAMP-PKA signaling and phosphodiesterase 10A expression: mechanistic insight and potential target for Lesch-Nyhan disease? *PLoS One*. 2013;8(5):e63333. <https://doi.org/10.1371/journal.pone.0063333>
88. Göttle M, Burhenne H, Sutcliffe D, Jinnah HA. Purine metabolism during neuronal differentiation: the relevance of purine synthesis and recycling. *J Neurochem*. 2013;127(6):805–18. <https://doi.org/10.1111/jnc.12366>
89. Mastrangelo L, Kim JE, Miyanojara A, Kang TH, Friedmann T. Purinergic signaling in human pluripotent stem cells is regulated by the housekeeping gene encoding hypoxanthine guanine phosphoribosyltransferase. *Proc Natl Acad Sci USA*. 2012;109(9):3377–82. <https://doi.org/10.1073/pnas.1118067109>
90. Dammer EB, Göttle M, Duong DM, Hanfelt J, Seyfried NT, Jinnah HA. Consequences of impaired purine recycling on the

- proteome in a cellular model of Lesch–Nyhan disease. *Mol Genet Metab.* 2015;114(4):570–9. <https://doi.org/10.1016/j.ymgme.2015.02.007>
91. Dauphinot L, Mockel L, Cahu J, Jinnah HA, Ledroit M, Potier M, et al. Transcriptomic Approach to Lesch-Nyhan Disease. *Nucleosides Nucleotides Nucleic Acids.* 2014;33(4-6):208–17. <https://doi.org/10.1080/15257770.2014.880477>
  92. Kang TH, Park Y, Bader JS, Friedmann T. The housekeeping gene hypoxanthine guanine phosphoribosyltransferase (HPRT) regulates multiple developmental and metabolic pathways of murine embryonic stem cell neuronal differentiation. *PLoS One.* 2013;8(10):e74967. <https://doi.org/10.1371/journal.pone.0074967>
  93. Nguyen KV. Epigenetic regulation in amyloid precursor protein and the Lesch-Nyhan syndrome. *Biochem Biophys Res Commun.* 2014;446(4):1091–5. <https://doi.org/10.1016/j.bbrc.2014.03.062>
  94. van der Zee SP, Lommen EJ, Trijbels JM, Schretlen ED. The influence of adenine on the clinical features and purine metabolism in the Lesch-Nyhan syndrome. *Acta Paediatr Scand.* 1970;59(3):259–64.
  95. Page T, Barshop B, Yu AL, Nyhan WL. Treatment of Lesch-Nyhan syndrome with AICAR. *Adv Exp Med Biol.* 1994;370:353–6.
  96. McCarthy GT, Green EM, Ogunbona O, Simmonds HA, Fairbanks L, Pountney T, et al. A population study of Lesch-Nyhan disease in the UK. *Dev Med Child Neurol.* 2011;53(1):34–9. <https://doi.org/10.1111/j.1469-8749.2010.03786.x>
  97. Glick N. Dramatic reduction in self-injury in Lesch-Nyhan disease following S-adenosyl methionine administration. *J Inherit Metab Dis.* 2006;29(5):687. <https://doi.org/10.1007/s10545-006-0229-8>
  98. Dolcetta D, Parmigiani P, Salmaso L, Bernardelle R, Cesari U, Andrighetto G, et al. Quantitative evaluation of the clinical effects of S-adenosylmethionine on mood and behavior in Lesch-Nyhan patients. *Nucleosides Nucleotides Nucleic Acids.* 2013;32(4):174–88. <https://doi.org/10.1080/15257770.2013.774012>
  99. Chen BC, Balasubramaniam S, McGown IN, O'Neill JP, Chng GS, Keng WT, et al. Treatment of Lesch-Nyhan disease with S-adenosylmethionine: experience with five young Malaysians, including a girl. *Brain Dev.* 2014;36(7):593–600. <https://doi.org/10.1016/j.braindev.2013.08.013>
  100. Lauber M, Plecko B, Pfiffner M, Nuoffer JM, Häberle J. The effect of S-Adenosylmethionine on self-mutilation in a patient with Lesch-Nyhan Disease. *JIMD Rep.* 2017;32:51–7. [https://doi.org/10.1007/8904\\_2016\\_571](https://doi.org/10.1007/8904_2016_571)
  101. Visser JE, Schretlen DJ, Bloem BR, Jinnah HA. Levodopa is not a useful treatment for Lesch-Nyhan disease. *Mov Disord.* 2011;26(4):746–9. <https://doi.org/10.1002/mds.23478>
  102. Göttele M, Prudente CN, Fu R, Sutcliffe D, Pang H, Cooper D, et al. Loss of dopamine phenotype among midbrain neurons in Lesch-Nyhan disease. *Ann Neurol.* 2014;76(1):95–107. <https://doi.org/10.1002/ana.24191>
  103. Pozzi M, Piccinini L, Gallo M, Motta F, Radice S, Clementi E. Treatment of motor and behavioural symptoms in three Lesch-Nyhan patients with intrathecal baclofen. *Orphanet J Rare Dis.* 2014;9:208. <https://doi.org/10.1186/s13023-014-0208-3>
  104. Taira T, Kobayashi T, Hori T. Disappearance of self-mutilating behavior in a patient with Lesch-Nyhan syndrome after bilateral chronic stimulation of the globus pallidus internus. *Case report. J Neurosurg.* 2003;98(2):414–6. <https://doi.org/10.3171/jns.2003.98.2.0414>
  105. Cif L, Biolsi B, Gavarini S, Saux A, Robles SG, Tancu C, et al. Antero-ventral internal pallidum stimulation improves behavioral disorders in Lesch-Nyhan disease. *Mov Disord.* 2007;22(14):2126–9. <https://doi.org/10.1002/mds.21723>
  106. Abel TJ, Dalm BD, Grossbach AJ, Jackson AW, Thomsen T, Greenlee JD. Lateralized effect of pallidal stimulation on self-mutilation in Lesch-Nyhan disease. *J Neurosurg Pediatr.* 2014;14(6):594–7. <https://doi.org/10.3171/2014.8.PEDS1451>
  107. Piedimonte F, Andreani JC, Piedimonte L, Micheli F, Graff P, Bacaro V. Remarkable clinical improvement with bilateral globus pallidus internus deep brain stimulation in a case of Lesch-Nyhan disease: five-year follow-up. *Neuromodulation.* 2015;18(2):118–22. <https://doi.org/10.1111/ner.12261>
  108. Wade-Martins R, White RE, Kimura H, Cook PR, James MR. Stable correction of a genetic deficiency in human cells by an episome carrying a 115 kb genomic transgene. *Nat Biotechnol.* 2000;18(12):1311–4. <https://doi.org/10.1038/82444>
  109. Cattelan P, Dolcetta D, Hladnik U, Fortunati E. HIV-1 TAT-mediated protein transduction of human HPRT into deficient cells. *Biochem Biophys Res Commun.* 2013;441(1):114–9. <https://doi.org/10.1016/j.bbrc.2013.10.029>



**FIGURE LEGENDS**

**Figure 1.** Purine salvage/breakdown (grey inset) and diagram of purine and pyridine metabolism.

SAICAR: succinylaminoimidazolcarboxamide ribotide; AICAR: aminoimidazolcarboxamide riboside; PRA: phosphoribosylamine; BH4: tetrahydrobiopterin; FH4: formyltetrahydrofolate; SAM: S-adenosyl methionine; SAH: S-adenosyl homocysteine; NA: Nicotinic acid; Nam: Nicotinamide; NAMN: Nicotinic acid mononucleotide; NMN: nicotinamide mononucleotide.

1, PRPP synthetase; 2, Adenylosuccinate lyase; 3, AICAR ribotide transformylase/IMP cyclohydrolase; 4, IMP dehydrogenase; 5, GMP synthetase; 6, GMP reductase; 7, AMPS synthetase; 8, Hypoxanthine-guanine phosphoribosyltransferase; 9, Adenine phosphoribosyltransferase; 10, Ado deaminase; 11, 5'-nucleotidase; 12, Purine nucleoside phosphorylase; 13, Adenosine kinase; 14, AMP kinase; 15, AMP deaminase; 16, Nucleoside monophosphate kinase; 17, dGuanosine kinase (mitochondria); 18, Xanthine oxydase; 19, Guanase; 20, GTP-cyclohydrolase 1; 21, NA phosphoribosyltransferase; 22, NAM phosphoribosyltransferase; 23, NAMN-adenylyltransferase; 24, NMN-adenylyltransferase; 25, PolyADPR polymerase; 26, Ribonucleotide reductase; 27, dCytidine kinase; 28, Glutamine-phosphoribosylpyrophosphate amidotransferase; 29, SAH hydrolase.

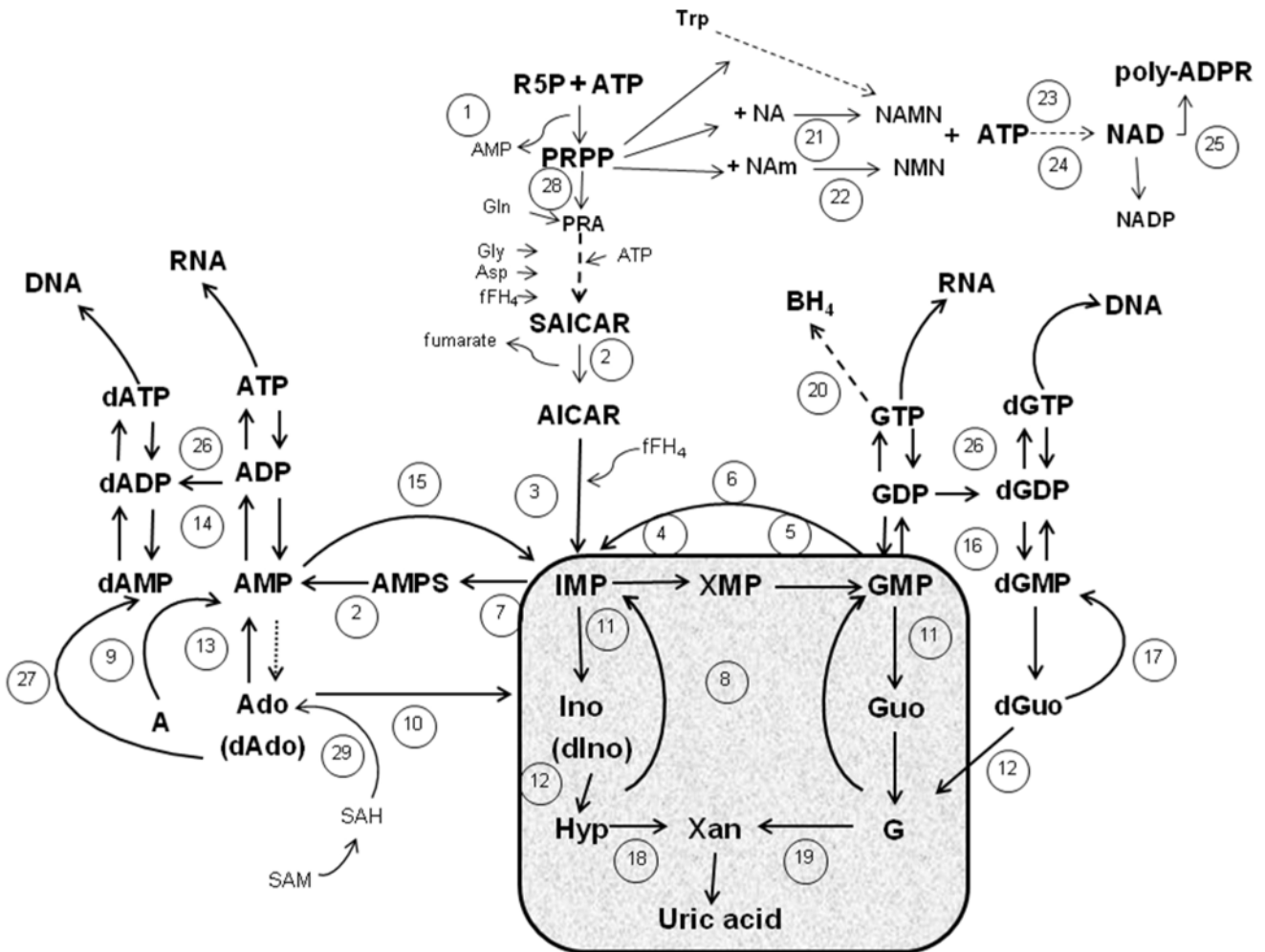
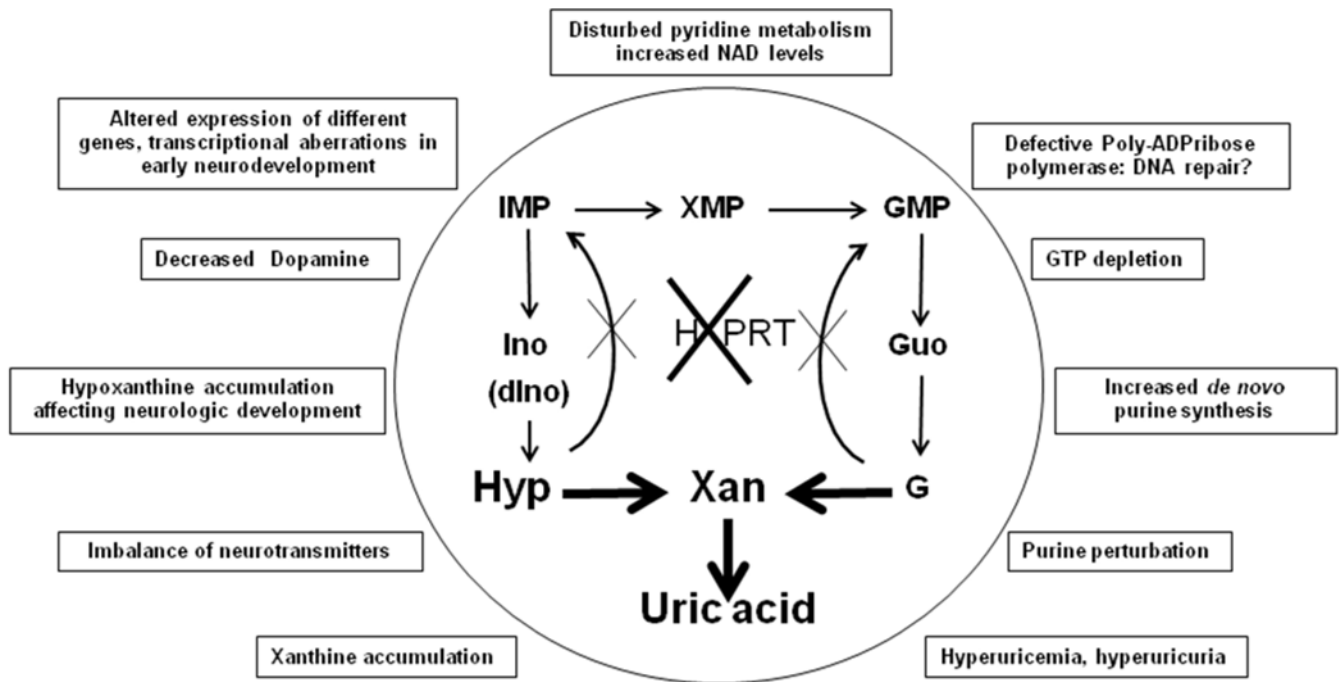




Figure 2. HPRT deficiency: metabolic alterations which may lead to LND.



# OUT-LOOK ON THE DEVELOPMENT OF RUSSIAN EDUCATION IN THE CONTEXT OF WORLD TRENDS

E. Avdeeva<sup>1</sup>, S. Nikulina<sup>1</sup>, I. Artyukhov<sup>1</sup>

<sup>1</sup>V.F. Voino-Yasenetsky Krasnoyarsk State Medical University, Krasnoyarsk, Russian Federation

## Abstract

The article discusses the state of Russian education system of future. It is noted that for the effective change of educational process organization, for the increase of modern students' motivation, it is necessary to reconsider the methods, technologies and the content of higher education, taking global world trends into account. In order to study the out-look on the development of higher education, the following world trends were identified: remote technologies and digital educational resources; creation of digital universities' models and certification centres for external independent assessment of professional qualifications; introduction of general language for teaching in the system of higher education; organization of training via interactive lectures of the best teachers of the world; introduction of playing and electronic simulators into educational process. However, the attitude to the issues of digitalization of domestic education is debatable in pedagogical circles, dividing the audience into supporters and opponents of this phenomenon, as far as digitalization causes not only a significant change in the appearance of modern education, but digital technologies are aimed at the change of the nature of a person bodily and spiritually. The latest technologies are used for this very purpose, among which are NBIC-technologies – nano, bio, information and cognitive ones. Digital educational space should not do any harm to a person. So, all the participants of this global project, both developers and experts, must take into account the negative consequences of the impact of digital technology on humans. They should not make them the means of destroying domestic education, its culture and morality. If digital technologies are put at the service of a person, Russian higher schools will be really modernized, as well as, medical education in general.

## Keywords

*digital education • digital pedagogy • digital university • digital educational resources • digital educational technologies • playing electronic simulators.*

## Introduction

The generation of modern medical students, grown up in specific conditions of constant social and economic changes, comes to medical school with their own peculiarities and needs. To ensure that doctors are able to master intellectual and professional skills of high quality demanded in the health care market, educators, who are the representatives of older generations, should reconsider the methods, technologies and the content of higher education, change the atmosphere of studying process in order to promote the success of any student as much as possible. To organize the educational process effectively, it is necessary to take into account a number of factors, global and regional trends that go beyond the vocational training and the experience level of employees in the system of higher education [1]. A mature teaching staff, especially the one of a medical school, follows classical, fundamental medicine that is a search and visual demonstration of the “truth”, existing in the form of a system of fundamental and universal knowledge.

However, the situation in the field of education is changing considerably and, in this connection, it is necessary to realize that the students, entering the university, are quite different from what they were before [2]. Nowadays students often deny both the scientific facts themselves and the authorities in science<sup>1</sup>. They come into conflict with fundamental approaches in higher education [3]. Not rarely students behave disrespectfully, and many teachers are incapable to resist it, as a result, the classes become less effective and the atmosphere in the audience becomes less productive. In such a situation, it is natural to seek help in pedagogy, one of the purposes of which is to study the goals and methods of teaching, to search for optimal ways of delivering information to the audience

<sup>1</sup> Howe N, Strauss W. Millennials rising: the next great generation [Internet]. Vintage Books, 2000. [cited Jan 24 2015]. Available from: <http://books.google.ru/books?id=vmNkJ9oYc2IC>.

by a teacher, improving the learning process. An appeal to pedagogical science will make it possible to resolve the marked contradiction between the traditional way of teaching and the needs of students in a new model of learning more effectively [4].

## Methods

To eliminate the mentioned contradiction between the needs of modern students and the state of traditional education system, we will rely on theoretical methods of cognition, including: analysis (the process of mental separation of any phenomenon into parts (features, characteristics, relations), synthesis (fusion of parties, identified while being analysed, into a single whole), abstract modelling of educational situation, application of theoretical and logical operations of induction and deduction. These methods require empirical facts. Such facts were collected while studying the literature in the field of modern education, while observing actual events that take place in high school.

The following documents made the empirical basis of the study:

- The concept of long-term social and economic development of the Russian Federation for the period up to 2020 (the Order of the Government of the Russian Federation dated November 17, 2008 No. 1662-p);
  - The report of Oxford University Research Centre “International Trends in Higher Education 2016-2017”;
  - The speech of the head of Sberbank German Gref “About the trends of the new digital era”. Ekaterinburg, July 26, 2017.
- Therefore, both theoretical and empirical methods of studying the trends in the field of education development supplement each other and exist in unity.

## Results

Before studying the problem of Russian education development outlook in the context of world trends, let us ask such pedagogical question as: what is currently happening in the field of education?

Firstly, the essence of teaching process is the transmission of knowledge from a teacher to a student on the basis of lecture and practical classes, as far as traditional university education is based on the value of knowledge. Therefore, it is necessary to acquire certain blocks of knowledge while spending a lot of time in classrooms, in libraries preparing for classes. Such activities ennoble a person, makes him or her wiser and stronger. At least Wilhelm von Humboldt believed in it, creating the model of university in its present form at the beginning of the nineteenth century.

Secondly, knowledge should be ideally transformed into practical skills by means of a set of practical training forms such as seminars, laboratory works, trainings, case studies, master classes, etc. All these forms of applied training imitate the context of future professional activity.

Nevertheless, nowadays communication intensity has increased many times, it leads to rapid thinking, fast switch from one subject to another [5]. A young person, grown up in the digital age, can hardly find common language with a professor, who has received classical education. All the teachers simultaneously note the loss of learning motivation. And, the consequence of the previous idea is a weak motivation for academic activities for both students and teaching staff.

The teachers understand real motives of their students for entering (to move to another city, to fulfil some social program, to prolong childhood, etc.) and, therefore, they are not anxious to demand much [6]. Low level of income and social status of university teacher decrease the remnants of motivation to do work properly. Unfortunately, Russia, lags behind the world leaders in such pedagogical parameters as: education goal-setting, digitalization of academic environment, social level of teaching staff and students, organization system, human and material resources, E-learning [7]. At best, only some Russian universities will be able to integrate into the system of transnational universities. What could be done in such a situation in obviously not favourable terms?

The first step in Russian system of education in this direction is done by remote technologies and digital educational resources [8]. Delivering knowledge and its transformation into skills is possible even without physical presence of a group of people in one place and at the same time [9]. For example, one can take a course of mathematics, given by the best world-known professor, might be physically anywhere at the moment, so one can take it on-line. But, at the same time, not all kind of knowledge and skills can be brought to the network. First of all, it concerns many medical courses and disciplines, e.g. surgery, cardiology, dentistry, which require long-term work both individually and in a group with a teacher. Nevertheless, there is a number of subjects, courses and disciplines with a prospect of entering digital network, and moreover, the creation of a university on a digital platform. Therefore, let us consider in details the first direction of changes in the system of higher education, called “Digital Universities and Certification Centres”.

The creation of digital university model will require an appeal to another type of pedagogy. This is the pedagogy of digital education [10]. In digital educational space, classical pedagogical theories face completely new conditions. A new digital educational environment is being formed, and nobody nowadays can still define it. It is clear that this is an experimental, pioneering space in which everything is done for the first time: digital models, digital electronic textbooks,

digital educational materials [11] are being created for the first time; the content of higher education is being updated in the context of global trends [12]. "The new large data can be used for deeper assessment of knowledge and skills, deepening the links between all levels of learning, establishing contacts between educational institutions, students and employers, rating academic progress"<sup>2</sup>.

The term "university" as a typical way of self-organization of higher education, will remain in the academic environment at the very beginning. But on the basis of traditional universities a part of digital ones will start to appear. Another part will be formed on the basis of the largest technological enterprises. Finally, free associations of teachers will appear. At the same time, traditional academic education will remain. But it will be reduced many times and will have a single goal – to reproduce the learned elite from the gifted students [13].

In the conditions of digital education, Certification Centres will appear. These centres are created to grade the quality of specialist's training. Specialist's training will be carried out on the basis of formation of "continuous education system, based on introduction of national qualification framework, qualification certification system, modular programs that will maximize the use of human potential and create conditions for self-realization of citizens during the whole life ..."<sup>3</sup>. Creation of modern system of continuous education, training and retraining of professional staff needs creation of system of external independent certification of professional qualifications<sup>4</sup>. Applying to a Centre, a person takes qualification exam, which shows the level of skills and competencies' mastery. Depending on the result of the exam, a person has the right to occupy a certain position. Many positions will require several exams. In such a situation, the Diploma disappears as useless, first of all, due to the fact that education will have no strict temporal and spatial limitations. In this case, a unified scale of points, single for the whole country, will be developed. It will include information on what a person should know and what s/he should be good at, as well as methods and ways of verification. The transfer of exams from university to certification centres will stop subjective evaluation. In accordance with the received points, a person can get a certain social position. Prerequisites for new assessment of graduates' qualifications have appeared long ago. For example, these are global standardized exams such as TOEFL, GRE, GMAT, etc. Unified final school and university entrance examinations are widespread in different countries of the world, e.g., USE – in Russia, SAT – in the USA, etc. There appeared a huge number of centres of additional education, training centres, etc. In short, an alternative to higher education sector is being developed.

What will the system of Russian higher education be like in future? It is difficult to answer this question unambiguously. Nevertheless, it is possible to consider some more trends that are already being actively introduced on the basis of Russian

universities and which are most likely to be further developed in the next 10-20 years [14].

Firstly, there will be single language of teaching in the system of higher education. And it will be English. Even now, as Bulyzhenkov I. E. and Soloviev O. N. note, there are courses or educational programs in English in thousands of universities all over the world [15, p. 64]. Migration to different parts of the world becomes as typical as a trip to a neighbouring city. Knowledge of basic English will become an obligatory condition for a full life all over the world. Therefore, teaching different disciplines in English in higher education system is the requirement of modern time. But the system of medical education in Russia offers bilingual educational programs both in Russian and English, as not all patients, who are Russian citizens, will speak English in the nearest future. One of the very important tasks for a doctor is to establish a good contact with a patient and this can be done only in the patient's native language. In this regard, during their years of education, medical students should develop literate native speech, along with learning English as foreign language.

The second tendency, as it was mentioned above, is the organization of training by means of interactive lectures given by the best teachers [15, p. 67]. Each subject can be studied from the most talented teachers of each university discipline<sup>5</sup>. Such teachers can explain the most complicated concepts in simple words, their classes will bring listeners enthusiasm and desire to become scientists. All the lectures of these teachers are digitized and provided with colourful illustrated materials. After each lecture, a teacher offers tasks for self-decision making, as well as the analysis of correct or incorrect answers given by a student. Every student can ask any question, searching for it or selecting from a list. If there is no answer to the question, the teacher will be informed about it. After a while, he will record a video response and fill up the ever-growing knowledge base. It will take several years of classes on such a program, and there will be no questions without answers. In a new digital age, the best teachers will be able to train millions of people, and even a student from Siberia will have an opportunity to communicate with the most talented teachers [14].

<sup>2</sup> Manifest about digital educational environment EdutInMe. Non-commercial initiative [Internet]. [cited Apr 28 2018]. Available from: <http://manifesto.edutainme.ru>

<sup>3</sup> The concept of long-term social and economic development of the Russian Federation for the period up to 2020. Order of the Government of the Russian Federation № 1662-p (Nov 17, 2008).

<sup>4</sup> Federal target program of education development for 2011-2015, task 3, activity 8 "Development of quality of vocational education assessing system based on establishment and implementation of certification mechanisms for qualifications of specialists and graduates of educational institutions, taking into account the integration of FSIS requirements and professional standards"

<sup>5</sup> Pervyh S. How to improve medical education? Experience of Surgut State University [Internet]. [cited 2015 Jan 24]. Available from: <http://www.edutainme.ru/post/kak-sdelat-meditsinskoe-obrazovanie-luchshim-v-mire>; Pavel Durov disputes on the education system [Internet]. [cited 2018 Apr 28]. Available from: <http://liberatum.ru/news/pavel-durov-razmyshlyaet-o-sisteme-obrazovaniya>.

The indicator of this process is the fact of creation an online university, which quickly passes the corporate framework by the world's largest technology companies (Google, Apple, Microsoft, Facebook, etc.). Such projects as Coursera and EdX (mass online education sites) are growing very fast and are gaining a huge number of students around the world. And as a result, most of the courses and educational programs will transfer to the network. First of all, it concerns disciplines of general education, humanities and social sciences. This will cause a significant reduction in teaching staff, studying rooms, etc. At the same time, the importance of the administrative apparatus of higher educational institutions will decrease, as there will be no need in deans, vice rectors, heads of departments, since the service provider (professor, teacher) can access the client (student) directly [16].

However, this trend has its dark side. Firstly, the use of only the best teachers in educational process establishes monopoly of views on certain problems of medicine and, possibly, will limit creation of the alternative approaches. Secondly, giving lectures to thousands and millions of students does not allow to make it really interactive, because even genius professor has only 24 hours a day and can respond effectively to no more than 10-20 questions.

The next trend, which already changes the form of future education, is the introduction of playing simulators into the educational process<sup>6</sup>. Simulation (imitation) forms of education in pedagogy are becoming more and more relevant [17]. The simulation approach implies such design of learning process, in which the learner acts in an unreal (playing) situation knowing about it. Therefore, the degree of convention of playing can be different: from improbable and fantastic to extremely close to the reality (simulators imitating tank or spacecraft control, or a course of surgical operation). The development of electronic simulators requires algorithmization of the most delicate intellectual, emotional and sensory processes. "Problems which in real pedagogical communication are solved by inspiration, semi-consciously or completely unconsciously, needs here its differentiation, description and, finally, formalization" [17, p. 38]. That is why technologies of "electronic (digital) didactics" have essential practical and scientific significance that is not limited by e-learning [18, 19]. Firstly, a detailed (differentiated) simulation scenario is created which consists of separate fragments – cases. There goes the description of the situation for each of them that means the conditions, both virtual and real, in which participants of the game act. The situation sets the limits for the activities of the participants in the game. A specific combination of cases is the basis of the game scenario or a simulation game card. Relationships and dependencies are established between the cases, depending on the subject of study, they are: temporary, causal, conditional, etc. Besides, the plot lines of the game are determined. They can be linear,

might have dead-end moves, returns to the previous stages as a reaction by ineffective actions of trainees. It is also determined in advance whether the story lines are divided, how they are interrelated, where they converge and under what conditions they diverge. The way the data about the results of the passing certain cases by players are stored, whether they are recorded and remembered by a computer, whether it affect passing the further stages of the game are also of great importance.

Such approach to the development of electronic simulators is very valuable for full-time playing, because e-learning has clear criteria for grading the studying quality, detailing certain playing activities and the effects they cause, that in the conditions of "real" playing often "remains beyond the limits" being not fixed and reflected by moderators, being solved "by itself". Simulation playing gives a chance to experience certain forms of professional activity in circumstances that are safe from risks, costs and sanctions in cases of inappropriate behaviour.

Learning through immersion in the game world allows to get into different situations of Peter I era within the computer game. Costumes of the nobles and the city buildings are modelled exactly in accordance with the historical data on that era. While doing the tasks of the game, a student learns the life style of that time, gets acquainted with real historical characters. S/he can talk to virtual locals and completely immerse into the Peter's era, listening to dialogues among real historical characters. Historians, archaeologists, culturologists, linguists are to be involved in the process of creation of such games. This might sound like a utopia, but it is worth noting that such a game already exists, it is called *Assassin's Creed II*. And it is one of the most popular and commercially successful educational gaming projects in the world.

Interactive audio-visual tests can be also compiled in the framework of digital education system. Meanwhile, the test can be not only linguistic. Any kinds of tests can be visualized and voiced. It is possible to create colourful video on its basis with various answers – right and wrong, among which one needs to choose only the right one.

## Discussion

The issues of digitalization of national education are the most acute for the discussion among pedagogical academia [20, 21]. All the indicated trends are included, e.g. remote technologies and digital educational resources; creation of models of digital universities, certification centres for external

<sup>6</sup> Naumov VV. Potential of educational simulators [Internet]. [cited 2018 Apr 04]. Available from: <http://psyfactor.org/lib/naumov4.htm>



independent assessment of professional qualifications; introduction of general teaching language in higher education; the organization of training through interactive lectures by the best teachers of the world; introduction of educational playing simulators, etc. Of course, in most cases, it is the matter of our country joining the global educational space. However, sometimes there is another point of view. And in this connection there are two points of view – of the supporters and of vigorous opponents of the indicated phenomena. For example, the works of O. N. Chetverikova presents the idea that the consequences of digitalization of the Russian education are so destructive that even people far from politics understand that it is something more serious than simply upgrading the system of higher education [22]. The matter is that digital technologies are directed, first of all, to the change of a person and his/her essence. Therefore, it deals with the change of physical and spiritual nature of a person that is the main aim of latest technologies (NBIC) being used – nano, bio, informative and cognitive ones. Their key direction is a change in a person and making him/her as a kind of bio-object and the main source of profit. Nothing is said in this connection about the formation of an educated and developed personality serving the Fatherland, about the formation of patriots. The main thing for a graduate is to demonstrate a standardized set of competencies. And the main task of Certification Centres is to bring together students and business investors, so that the project, a student has developed, could be realized in some business. Education will become asynchronous, the whole teams will enter universities, develop some projects and protect them, and then some investor will purchase them. Students can then move to another university. Such a model exists at Singularity Institute, created by Google and NASA. One more controversial point is also worth mentioning – online learning, which is the main one in transformation of students' way of thinking and dismantling of our education system [23]. When in 2014 the concept of remote education was discussed, it was said that if it was introduced, classical universities would gradually disappear with digital ones of remote training to change them. This idea was given in the report of I. Peskov, who said that education in the future will be of two kinds – remote and human<sup>7</sup>. Remote education will be cheap, while the human one will be expensive. So, the elite remains with classical, human education, while the rest can afford themselves only remote learning. It is difficult to comment on such a turn in education system. But this topic requires serious discussion not to give the unequivocal impression that such transformation of higher school is the only possible one. Such a discussion is being conducted both in Russian scientific journals and in foreign ones. For example, the article "What works and why? Student perceptions of 'useful' digital technology in university teaching and learning. Studies in Higher Education" by Henderson M, Selwyn N,

Aston R. [3] informs scientific audience to their studies of students' perception of information effectiveness in the context of digital technology. They conclude that in the conditions of digitalization of teaching and learning at university, the level of perception and memory in modern students is significantly being reduced.

## Conclusion

Thus, mobile technologies change teaching in higher education radically. On the one hand, the use of applications will allow students to find new ways to handle routine tasks or to approach the solution of vital problems. The following phrase is widely used nowadays: "All the routine that can be given to robots, should be given to robots". In order to do this, it is possible and it is necessary to apply all available technological innovations and achievements of various fields [24].

But, on the other hand, there is a dangerous trend connected with the fact that innovative digital technologies will reformat the very nature of students, will bring them to entirely different system of values, will rebuild and format new worldview. It is necessary to understand that it is a matter of dismantling education system, because now a system filling a person with certain competences is being introduced instead of education. The education itself is being abolished. It is necessary to think more broadly and exceed the bounds of a subject, a department, a faculty, an institute, a university to avoid such a situation in the conditions of digitalization. It is necessary to arrange relationships with the largest libraries and educational platforms, to participate in discussions at international forums. One can try using new things being not limited by traditional forms of communication: start chatting and blogging; work together on documents, for example, in Evernote; use interactive whiteboards. It has turned out, a circle of like-minded people can be found anywhere – in another country, in another specialty. Nevertheless, it is necessary to see the danger of digital world. D. Medvedev in his speech at the forum "Open Innovation in "Skolkovo" Technological Park" on October 17, 2017 said: "Governments around the world need to hurry up, until an artificial intellect comes to power, and changes our organs, and presses "Delete" button in order to reset our brains ... Our task, in fact, is to join mutual forces to make the jump of mankind into the digital world well prepared. And I am sure we can do it. First of all, because we understand our responsibility today" [25]. Undoubtedly, in order to implement the above mentioned educational prospects, a lot is needed to be done, e.g. to create a real digital pedagogy.

<sup>7</sup> Peretolchin Dm. Dismantling. Zavtra [Internet]. [cited 2018 Mar 26]. Available from: <http://zavtra.ru/blogs/razrushenie>



Digital pedagogy, before being called pedagogy, needs to work out the principles and rules of its functioning in the context of the humanization of education. Digital educational space should do no harm to a person. And all participants of this global project, both developers and experts, should take into account all negative consequences of the impact of digital technologies on people and they should not make them a means of destroying the domestic education, culture

and morality. If digital technologies are put at the service of a person, Russian higher schools will be really modernized, as well as medical education in general.

### Conflict of Interest Statement

We declare that there is no conflict of interests.

### References

- Komleva VV. Russia in the context of new world trends in internationalization of higher education. *Central Russ J Soc Sci*. 2017;12(6):13-9. Russian. <https://doi.org/10.22394/2071-2367-2017-12-6-13-34>
- Baxter L, Mattick K, Kuyken W. Assessing health care students' intentions and motivations for learning: the Healthcare Learning and Studying Inventory (HLSI). *Adv Health Sci Educ Theory Pract*. 2013;18(3):451–62. <https://doi.org/10.1007/s10459-012-9383-y>
- Henderson M, Selwyn N, Aston R. What works and why? Student perceptions of 'useful' digital technology in university teaching and learning. *Studies High Educ*. 2017;42(8):1567–79. <https://doi.org/10.1080/03075079.2015.1007946>
- Schmidt EE, Cohen J. The new digital age. M.: Mann, Ivanov and Ferber LLC; 2013. 367 p. Russian.
- Hilbert M, Lopez P. The world's technological capacity to store, communicate, and compute information. *Science*. 2011;332(6025):60-5. <http://dx.doi.org/10.1126/science.1200970>
- Pedro E, Mendes L, Lourenço L. Perceived service quality and student's satisfaction in higher education: the influence of teaching methods. *Int J Qual Res*. 2018;12(1):165–92.
- Clarke T, Clarke E. Born digital? Pedagogy and computer-assisted learning. *Educ Train*. 2009;51(5/6):395–407. <https://doi.org/10.1108/00400910910987200>
- Koller D. What we're learning from online education [site]. [cited 2016 Nov 3]. Available from: [http://www.ted.com/talks/daphne\\_koller\\_what\\_we\\_re\\_learning\\_from\\_online\\_education?language=en](http://www.ted.com/talks/daphne_koller_what_we_re_learning_from_online_education?language=en)
- Gurwitz KT, Aron S, Panji S, Maslamoney S, Fernandes PL, Judge DP, et al. Designing a course model for distance-based online bioinformatics training in Africa: The H3ABioNet experience. *PLoS Comput Biol*. 2017;13(10):e1005715. <https://doi.org/10.1371/journal.pcbi.1005715>
- Beetham E, Sharpe R, eds. Rethinking pedagogy for a digital age: designing and delivering e-learning. N.Y.; 2007. 255 p.
- Baumgart DC, Wende I, Grittner U. Tablet computer enhanced training improves internal medicine exam performance. *PLoS ONE*. 2017;12(4):1–14.
- Leskova IA. Update of the content of higher education in the context of global trends in the development of education. *Prepodavatel XXI vek*. 2016;3:9-21. Russian.
- Healey N, Michael L. Towards a new framework for analysing transnational education. *High Educ Policy*. 2015;28(3):369–91. <http://dx.doi.org/10.1057/hep.2014.17>
- Avdeeva EA, Myagkova EG, Nikulina SYu. Global trends and future educational technologies. In: *University Pedagogy. Modern trends in the development of pedagogical technologies in medical education*. Krasnoyarsk: KrasSMU; 2015:34–8. Russian.
- Bulyzhenkov IE, Solovyev ON. A new paradigm of education at project universities-infrastructures may come from Russian science cities. *Metafizika*. 2014;4:61–75. Russian.
- Dryden G, Vos J. The Learning Revolution: to teach the world study in a new ways. M.: Parvine, 2003; 671 p. Russian.
- Gabdulkhakov VF, Galimova EG. Digital pedagogy and gamification of university education. *Education and self-development*. 2014;4:37–43.
- Pacheco E, Lips M, Yoong P. Transition 2.0: Digital technologies, higher education, and vision impairment. *Int High Educ*. 2018;37:1–10. <https://doi.org/10.1016/j.iheduc.2017.11.001>
- Petryaeva EYu. E-learning development vectors: pedagogy of cooperation and digital environment. *Successes Mod Sci Educ*. 2017;1(2):51–6.
- Brier S. Where's the Pedagogy? The Role of teaching and learning in the digital humanities [Internet]. In: Gold MK. *Debates in the Digital Humanities*. Minnesota: University of Minnesota Press; 2012. [cited 2017 Nov 3]. Available from: <http://dhdebates.gc.cuny.edu/debates/text/8>
- Virtanen MA, Haavisto E, Liikanen E, Kääriäinen M. Ubiquitous learning environments in higher education: A scoping literature review. *Educ Inf Technol*. 2018;23(2):985–98.
- Cheetverikova ON. Country Digitization as a National Idea [Internet]. Part 2. [cited Dec 18 2017]. Russian. Available from: <https://vstanzaveru.ru/o-n-chetverikova-otsifrovka-stranyi-kak-natsionalnaya-ideya-chast-2/>

23. Aiden E, Michel J-B. Uncharted: big data as a lens on human culture. M.: AST, 2016; 351 p. Russian.
24. Malinetskii G, Sirenko, S. Robotics and education: A new approach. Herald Russ Acad Sci. 2017;87(6):527–34. <https://doi.org/10.1134/S1019331617060107>
25. Medvedev D. Jump into the digital world before artificial intelligence [Internet]. Vedomosti. 2017 Oct 17. [cited 2017 Nov 7]. Russian. Available from: <https://www.vedomosti.ru/technology/news/2017/10/17/738220-medvedev-prizivaet>

# IMPACT OF POPULATION AGEING ON HOSPITAL CONSUMPTION AND MEDICAL DEMOGRAPHY IN METROPOLITAN FRANCE: THE EXAMPLE OF OBSTETRICIANS

K. Kononovich<sup>1</sup>, Jean-Marc Macé<sup>1</sup>, E. Yuryeva<sup>2</sup>

<sup>1</sup>LIRSA research laboratory, National Conservatory of Arts and Crafts (Cnam)

<sup>2</sup>Department of Economics and management, V.F. Voyno-Yasenetsky Krasnoyarsk State Medical University, Krasnoyarsk, Russian Federation

## Abstract

The challenges of medical demography have become a major issue today in France, mainly because of the conjunction of two phenomena. Namely, a massive retirement of the “baby boom” generation and a delay in the medical training induced by the “*numerus clausus*” that had not anticipated that phenomenon. Unfortunately, the repercussion of the population ageing on hospital consumption and consequently on medical demography is very poorly integrated into the calculation and implementation of the medical professions’ *numerus clausus* in 2010. Thus we suggest a model that not only identifies the effective demand for care on operational geographical scale, namely, the health territory, but that also makes a projection of healthcare consumption based on the age of population of each “health territory” in a T+1 future. To illustrate this model, we take as example the obstetricians’ activity in France.

## Keywords

Territory operational experience • health territory • ageing population • territorial predictive modelling • medical demography

## Introduction

The better territorial equity requires balance between supply and demand for care. But on which territory? At the local level, an operational infra-departmental territory or even sub-urban territory for large cities should be defined. The territorial consensus between participants can be reached by managing both the flows of users and the geographical distribution of specialists on French territory. Furthermore, the territory is not fixed in time, it changes in accordance with dynamics of its own population [1]. Among the determinants of health, the age variable is predominant in care consumption. The impact of population ageing on medical demography represents a significant issue today [2], but it is still not, unfortunately, properly integrated into the calculation and the implementation of the *numerus clausus*, i.e. a number of students admitted to each medical, dental, pharmaceutical and midwifery program after the first year of study [3]. So, it is legitimate for each discipline (medical, surgical, medical-surgical), or even for each specialty (urology, vascular surgery, obstetricians, etc.), to plan what their most likely activity would be in ten to fifteen years to come. The medical and surgical specialties assignment, introduced by the Hospital Patient Health Territory (HPST) law of July 21, 2009, allows now to manage the flows

and to control the geographical distribution of specialists on the French territory according to the regional *numerus clausus*. It is a regulated number which is fixed each year in accordance with population needs in care. The challenges of medical demography have become a major issue in public health taking into account the conjunction of two phenomena such as massive retirements of the “baby-boom” generation and a delay in the medical training due to the *numerus clausus* [4, 5] that had not anticipated this phenomenon. However, it is necessary to identify the more precise population dynamics at the local level in order to determine the dynamics at regional level.

The purpose of this study is to analyse the effective demand for care in the context of massive retirement of “baby boom” generation practitioners and a delay in the medical training induced by the “*numerus clausus*” that had not anticipated that phenomenon. The following questions are raised: the real population health care consumption, how can it be assessed? The health care supply, does it meet the population effective demand for care at the regional level? And will it be the case in the coming years? The example of the obstetricians’ activity in France will be studied.

## Operational space network

### Benchmark territory construction

The territory, as it is defined in the dictionary of health geography of Henri Pichéral [6], can be spelled out through different aspects. The territory is a spatial organisation with well-defined borders where “any administrative and functional (health sector, supervision)... authority, power, competence are exercised. And in case if balance, equity is not provided or not well provided, it requires the territory planning by health care planning”. But the territory is also a space “of a community with its routine, its lifestyle habits; the territory is perceived, it is viewed as a space experience (living area) ...” Thus the territory can be defined as an administrative space predetermined by the authority and based on the principle of *top-down* management, as well as a living area (experience territory) designed by users’ daily routine [7]. However, the experience territory remains unnoticed for a long time. This refers to the philosophical view of the subject as Berkeley’s [8] immaterialism stating “*esse is percipi aut percipere*” (Being means to be perceived or to perceive), which questions the very existence of the territory experience. But also to Kant’s [9] view and its concept of numen, an object of intellectual intuition, which brings to the concept of territory experience its right to exist (the territory is considered as a numen) [10]. Thus, it is necessary to study the daily practices of users, or the flows, to define the experience territory borders.

Since the end of the 1980s, the health geographers have been interested in defining the operational health territory [11, 12]. Many options have been explored in order to overcome an inappropriate and obsolete geographical division of “health sectorisation” resulting from the hospital law of 1970 [13, 14]. The “Juppé Ordinances”, which came into force in April 1996, have changed the hospital landscape as establishments had to provide each year the data of their activity to the newly created Regional Hospitalisation Agencies. Consequently, since 1999 the spatial activity of users can be tracked in each discipline or hospital specialty [15].

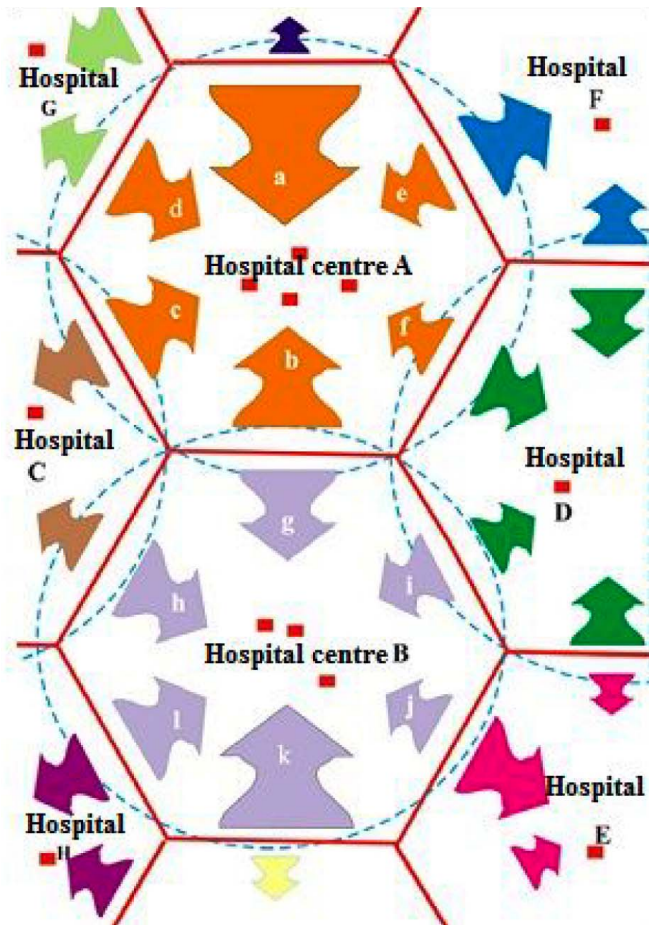
## Methods

The methodology of this study is based on the setting up of the operational network. The application of the operational network technique in health geography is inspired by the Mirabel method of The National Institute of Statistics and Economic Studies (INSEE) proposed in 1975 by J-J Ronsac and C. Terrier. This method is initially based on the analysis of users’ “home-work” flows in order to delimit the “employment territory” [16, 17].

To set up an operational network, the “departure-arrival” flows should be studied according to a given problematic (obstetrics, urology, etc.) by means of the “relative flow method”. Transposed to the hospital area, the “home-health centre” users’ flows are analysed. This method allows to define the territory operational experience based on users’ spatial practices which doesn’t necessarily coincide with administrative territory borders.

This territorial approach can be presented with a scheme. In Figure 1, each arrow symbolises, not only, the volume of hospitalised patients living on this territorial entity (municipality, postal code), but also the major orientation of hospitalisation flows (even in relative terms) living in each municipality or postal code. The method is based on a “descending sort” of each “place of departure” to all “place of arrival”.

Figure 1. Relative major orientation of hospitalized patients to a hospital centre



As a result, all municipalities (postal codes) are then classified without any overlap or omission, according to the importance of their place of departure and destination. All municipalities (or postal codes), whose major (even relative) flows of

hospitalised patients are directed to the same hospital centre, belong and constitute a health territory. The formulation of this major orientation of hospitalised patients to a hospital centre is represented as:

$$\text{Majority tie "Home - Hospital"} = \frac{\text{Hospitalised patients coming from the municipality "a" to the hospital center "A"}}{\sum \text{hospitalised patients coming from the municipality "a"}}$$

Where

« a » is a « departure » spatial entity of hospitalised patients ;  
 « A » is an « arrival » hospital centre of hospitalised patients;

As this analysis is carried out for a given discipline (obstetrics, etc.) or for a given specialty segment (births, etc.), it comes to defining a space which reflects a homogeneous spatial activity of hospitalised patients. This corresponds to a real "territory hospital experience".

## Results

### *The operational territorial network of obstetricians in France*

The analysis of the flows in the 545 maternity units in metropolitan France in 2015 allows to identify 328 lived birth territories (Map 1). There are 7000 practicing obstetricians in

metropolitan France to cover 800,000 births annually; however, the practitioners' density is not homogeneous on each spatial entity [18, 19].

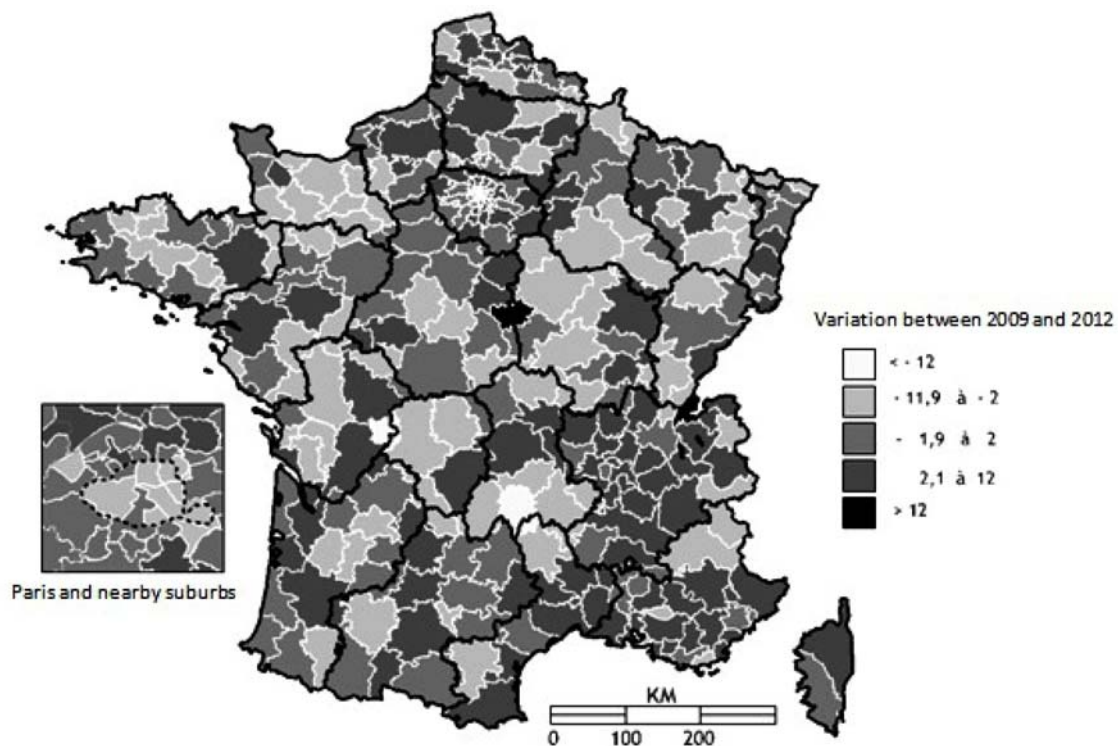
### *Differentiated spatial dynamics*

The demographic dynamics are not the same on each health territory, so it is necessary to estimate the most probable changes in birth trend for the near future. For this purpose, we construct a "predictive model" for operational spatial entities based on the demographic structure changing over time.

### *Predictive modelling*

This model proposes to estimate the healthcare consumption for "residents living on an operational territory" for the coming years (T1) [20]. Firstly, this model requires to identify the effective demand for hospital births at an operational geographical scale level in T0. Secondly, it proceeds to the projection of the number of hospital births according to population age structure on each health territory for T1 future. For this purpose, we perform a "standardization" according to age with the hospitalisation rates in T0, coming from Program for medicalization of the information systems (PMSI), on the age structure in T1 resulting from the OMPHALE-INSEE method [21, 22] on each health territory. The formula to

**Map 1.** Variation in hospital activity related to births in metropolitan France between 2009 and 2012.





estimate hospital activity expected in T1 future on the spatial entity is expressed as follows:

$$ExpT1 = \sum_k P1 \cdot t_{kT0}$$

Where:

**Exp T1**, is hospital activity on the spatial entity expected in T1;  
**k**, is an age range;

**P1**, is the population size of k- age group in T1;

**t<sub>kT0</sub>**, is the hospital activity rate of each homogeneous patient age group k in T0.

Thirdly and finally, the result obtained from the predictive model is compared to the situation really observed in T1. Thus, a weighting index to each spatial entity predictive model can be established as follows:

$$\lambda = \frac{ExpT1}{Act Obs T1}$$

Where:

$\lambda$  is a weighting index calculated on the basis of hospital activity between the period T0 and T1;

**Act Obs T1**, is hospital activity observed on the spatial entity in T1.

This weighting index is used then to calculate the activity projection for a T2 future which is more distant than T1. This weighting index  $\lambda$  allows to correct the trend of the projections obtained from the initial predictive model and related only to the impact of population ageing on the hospital births. Thus, it means to take into account changes in the medical practices and the ways of hospitalisation between T0 and T1 for T2 future which remains unknown.

Thus, the formula to estimate hospital activity expected in T2 future on the spatial entity is expressed as follows:

$$ExpT2 = \sum_k P2 \cdot t_{kT0} \cdot \lambda$$

Where:

**ExpT2**, is hospital activity expected in T2 future following T1 on the spatial entity;

**k**, is a range of homogeneous patient group;

**P2**, is the population size of k-group in T2;

**t<sub>kT0</sub>**, is the hospital activity rate of each homogeneous patient age group k in T0;

$\lambda$  is a weighting index calculated between T0 and T1.

This model is reliable for T2. Indeed, according to the research study published in 2012, the test on slope of regression line states that the volume of activity weighted and expected in T2 does not show any significant difference compared with the volume of activity observed in T2 [23, 24].

### Matching between supply and demand by 2020

The projection of hospital consumption related to births shows a slight growth at the national level between 2010 and 2020, i.e. 0.7% in 20 years. According to our model, the volume of hospital activity related to births in metropolitan France should rise from 777,800 acts (delivery and caesarean section) in 2010 to 783,100 acts in 2020, which amounts to an increase of 5,300 birth-related acts. However, this growth is far from being homogeneous across the country.

Finally, taking into account a consistent prospective vision means to group at the region level the results obtained at the local operational territories level. In this way, regional hospital demand related to births takes into account local features. In such a case, the *numerus clausus* related to the National Council of Universities (CNU) subsection of obstetricians should be increased in 3 regions, and decreased in Île-de-France (IDF) (Table 2).

### Discussion

The proposed model allowed to evaluate the effective demand of population for obstetrician care via the operational geographical network. As illustrated, the current administrative geographical division does not reflect population spatial dynamics. So the territory operational experience should be taken into account for better planning the number of specialists on each health territory. In 2015 Metropolitan France has 7000 obstetricians to cover 800 000 births per year, which corresponds to 114 acts on average per practitioner. However, the distribution of practitioners in France remains unequal [25, 26]. The areas of attraction with a significant concentration of practitioners can be identified, such as Île-de-France with 1,813 practitioners for 179,053 births in 2010, Rhône-Alpes region with 671 practitioners for 80,095 births and PACA (Provence-Alpes-Côte d'Azur) with 669 practitioners for 58,927 births; as well as territories with a lower concentration of practitioners, such as Limousin and Franche-Comté. If some disparities in hospital care regarding the effective demand are identified, what would happen in the years to come? This question is significant in view of changes in medical demography marked by the massive retirement of practitioners and the *numerus clausus* application. Indeed, the calculation of *numerus clausus*, which role is to settle the number of practicing doctors by region, takes into account only the number of retired practitioners, but does not integrate the dynamic of effective demand. A simple replacement of retirements will not be enough to cover the effective demand on some health territories which population continues to rise. It risks creating an important imbalance between supply and the effective demand for care between health territories.



**Table 2.** Estimated changes in number of obstetricians by region by 2020

Year Regions	2010		2020		V* 2009/2020	
	OB-GYN&GYN	Birth acts	OB-GYN&GYN	Birth acts	OB-GYN&GYN	Birth acts
Rhone Alpes	671	80 095	692	82 400	21	2,88
PACA	669	58 927	683	60 004	14	1,83
Midi Pyrenees	297	31 206	304	31 885	7	2,18
Aquitaine	364	33606	368	33 766	4	0,48
Nord Pas de Calais	424	55795	427	56131	3	0,60
Languedoc Roussillon	243	28913	246	29 248	3	1,16
Haute Normandie	149	22 282	151	22 624	2	1,54
Pays de la Loire	302	44633	304	44 661	2	0,04
Centre	226	29173	228	29 379	2	0,71
Auvergne	132	12952	133	12 986	1	0,26
Bourgogne	138	17 499	139	17 532	1	0,19
Picardie	160	22 925	161	23 141	1	0,94
Poitou Charentes	148	17 486	149	17 494	1	0,04
Alsace	225	22 009	226	22 087	1	0,36
Bretagne	297	36 830	297	36 770	0	-0,16
Limousin	56	7835	54	7591	-2	-3,12
Champagne Ardennes	112	15759	110	15 553	-2	-1,31
Lorraine	245	26152	243	25 865	-2	-1,10
Franche Comte	89	14 342	86	13 927	-3	-2,90
Basse Normandie	142	17 430	139	17 027	-3	-2,31
IDF	1813	179 053	1807	180 161	-6	0,62
Metropolitan France	6 902	774 903	6949	780 224	47	0,69

This has been demonstrated by our model by identifying the effective demand in T0 period, which has allowed to estimate the effective demand for care in the coming years.

Thus, significant changes in number of births are estimated by 2020 in three regions of Metropolitan France, such as Rhône-Alpes, PACA and Midi-Pyrénées, which will welcome 2,305, 1,077 and 679 births more respectively. It should also be noted that despite a high concentration of practitioners in these regions, especially in Rhône-Alpes and PACA, the current supply of care will not be sufficient to cover the increase in population health care needs. Indeed, in order to satisfy the actual population demand in care without overloading practitioners (taking as a reference the average number of acts per region and per practitioner), the Rhône-Alpes region will need 21 practitioners more in addition to the replacement of retired practitioners, the PACA region will need 14 practitioners more and the Midi-Pyrénées region 7

practitioners more (Table 2). Consequently, the *numerus clausus* should be increased in these regions.

The region of Brittany should be also mentioned with a slight decline in the number of births by 2020; however it would not have any impact on medical demography.

The proposed model also allows to identify a practitioner surplus in the Île-de-France region, which represents 6 practitioners. In this case, the *numerus clausus* for the Île-de-France region should be reduced by 6. The practitioner surplus has its impact on the care consumption as well. Indeed, previous studies have proved the impact of the increasing number of practitioners on the care consumption. This phenomenon, which refers to Say's law of markets, has been analysed by health economist Robert Evans, who has determined that the increase in the number of practitioners will inevitably lead to an increase in the care consumption and so to the growth of health care costs [27].

Thus, basing on the proposed model results, we can conclude that the *numerus clausus* should be adjusted to the effective demand at region level in order to satisfy the population needs in health care in the coming years. A particular attention should be paid to the regions of Rhône-Alpes, PACA, Midi-Pyrénées and Île-de-France.

## Conclusion

This research aims primarily to provide the most realistic territorial diagnosis in order to present an objective expertise to “public authorities”. However, it is regrettable that the National Observatory of Health Professionals (ONDPS) still does not integrate in 2012 the impact of population ageing on the medical and surgical care in the calculation of the *numerus clausus* for each specialisation. Indeed, the simple replacement of retired doctors will not be enough to maintain the same level of activity for each practitioner. The impact of population ageing will inevitably lead to an increase of practitioners’ activity. This is due to the fact that the delegation of medical tasks to paramedical practitioners does not reach unanimous agreement among health practitioners, on the one hand, and that the estimation of *numerus clausus* is based only on the number of retired practitioners, on the other hand.

Moreover, in terms of spatial equity, population will be unequally provided with healthcare which will be more and more dissociated from population real health needs. In geography, the paradigm is based on the principle that the knowledge of the “local” level allows to aggregate “larger spatial entities”. This “Girondine” approach, so federalist, offers the best possible vision on care consumption in order to define then a precise geographic network. In these circumstances, the “dialectical game” of overlaying geographical scales allows to build the best possible matching between supply and “needs of care” of population, or rather, population effective demand for healthcare consumption.

## Conflict of interest statement

The authors certify that they have NO affiliations with or involvement in any organization or entity with any financial interest (such as honoraria; educational grants; participation in speakers’ bureaus; membership, employment, consultancies, stock ownership, or other equity interest; and expert testimony or patent-licensing arrangements), or non-financial interest (such as personal or professional relationships, affiliations, knowledge or beliefs) in the subject matter or materials discussed in this manuscript.

## References

1. Zipf G. Human behavior and principle of least effort. Cambridge, Massachusetts: Addison-Wesley press; 1949.
2. Langlois J. Medical demography from 2003 to 2025 present and future difficulties. Bull Acad Natl Med. 2004;188(4):675-691; discussion 691-3. <https://www.ncbi.nlm.nih.gov/pubmed/15587687>
3. Huguier M, Romestaing P. Numerus clausus and medical demographics in France. Bull Acad Natl Med. 2014;198(7):1367-78. <https://www.ncbi.nlm.nih.gov/pubmed/27120909>
4. Macé JM. Medical demography of surgeons in France. Report for International Center for Research in Health Economics CIREs, EN3S. St Etienne; 2007. French.
5. Benahmed N, De Wever A, Pirson M. Medical supply planning : dynamic registry of physicians, sixth reform of the State and numerus clausus. Rev Med Brux. 2017;38(2):103-11. <https://www.ncbi.nlm.nih.gov/pubmed/28525252> French.
6. Picheral H, ed. Dictionary of Health Geography. Montpellier: Université Montpellier III-GEOS; 2001. French.
7. CreDES. Territories and Access to Care: Report of the Working Group. 2003. French.
8. Scala A. Berkeley: Les Belles Lettres. Paris; 2007. French.
9. Kant E; Renault A, ed. Critique of Pure Reason. Paris; 1997. French.
10. Macé JM. Operational use of the actual health territory in planning. Villes en Parallèle. 2010;44:158-75. French. <https://doi.org/10.3406/vilpa.2010.1479>
11. Ciceri MF, Marchand B, Rimbert S. Introduction to the space analysis: collection of applicable Geography. Masson; 1977. French.
12. Terrier C. Tools (Ed.). INSEE Methodes. 1998;83:57-74. French.
13. Thouez JP. Spatial organization of care systems. Montreal: Presses de l'Université de Montréal; 1987. French.
14. Tonnellier F. Geography of care, economic geography, studies of various geographical contours in France. Paris: CREDES; 1990. French.
15. Macé JM, Picheral H. Territory experience: medical territory. In: Kervasdoué J. The health notebooks of France. Paris: Dunod; 2004:146-64. French.
16. Terrier C. Mirabelle. Paper presented at the Second international days on data analysis. Versailles; 1979. French.

17. Terrier C. The structures of the French space by alternating migrations. Paper presented at the Internal and External Migration in Western Europe, Lille. 1980. French.
18. Macé JM. Tools for hospital planning: the example of the Lagny-sur-Marne hospital. Notebook on sociology and medical demography. 2003;43:115-48. French.
19. Macé JM. The threat of regional imbalances. Health Tribunes. 2006;12:45-55. French.
20. Macé JM. The notion of "territory" as a tool for health planning. Regards. 2007;31:97-111. French.
21. Brutel C. Projections of population by 2050: aging is inevitable. INSEE First. 2001:762. French.
22. Descours L, Poinat F. The demographic projection model OM-PHALE. INSEE Méthodes. 1992;19:65. French.
23. Berger L, Mace JM, Ricco JB, Saporta G. Methodology for the evaluation of vascular surgery manpower in France. Public Health. 2013;127(1):65-71. <https://doi.org/10.1016/j.puhe.2012.09.002> <https://www.ncbi.nlm.nih.gov/pubmed/23046888>
24. Berger L, Mace JM. Vascular surgeons in France: an endangered species? Ann Vasc Surg. 2012;26(8):1154-9. <https://doi.org/10.1016/j.avsg.2012.03.005> <https://www.ncbi.nlm.nih.gov/pubmed/22819526>
25. National Observatory of Health Professions (ONDPS). Report 2013-2014. 2014. French.
26. The Organisation for Economic Co-operation and Development. Health Panorama 2015. 2015. French.
27. Evans R. Supplier-Induced Demand: Some Empirical Evidence and Implications. In: Perleman M, editor. The Economics of Health and Medical Care. International Economic Association. London: Palgrave Macmillan; 1974:162-73. [https://doi.org/10.1007/978-1-349-63660-0\\_10](https://doi.org/10.1007/978-1-349-63660-0_10)

# MEDICAL EXCHANGE PROJECT FOR STUDENTS AND YOUNG DOCTORS BETWEEN JAPAN AND RUSSIA

S. Yamakawa<sup>1</sup>, O. Razvina<sup>1</sup>, M. Ito<sup>2</sup>, H. Hibino<sup>3</sup>, T. Someya<sup>4</sup>, T. Ushiki<sup>5</sup>

<sup>1</sup>Globalization and Medical Exchange Control Center, Niigata University School of Medicine; 1-757, Asahimachi-dori, Chuo-ku, Niigata, Japan 951-8510

<sup>2</sup>Comprehensive Medical Education Center, Department of Medical Education Promotion, Niigata University School of Medicine; 1-757, Asahimachi-dori, Chuo-ku, Niigata, Japan 951-8510

<sup>3</sup>Department of Molecular Physiology, Niigata University School of Medicine; 1-757, Asahimachi-dori, Chuo-ku, Niigata, Japan 951-8510

<sup>4</sup>Department of Psychiatry, Niigata University School of Medicine; 1-757, Asahimachi-dori, Chuo-ku, Niigata, Japan 951-8510

<sup>5</sup>Division of Microscopic Anatomy, Niigata University School of Medicine; 1-757, Asahimachi-dori, Chuo-ku, Niigata, Japan 951-8510

## Abstract

For more than 25 years Niigata University School of Medicine has been organizing medical exchanges with universities of the Russian Far East and Siberia. This exchange has turned out to be mutually beneficial for both universities, giving motivation to medical students and young doctors to strive for knowledge of international medicine. “Program for priority placement of foreign students sponsored by Japanese government” and “Re-inventing Japan project” initiated by Japanese Ministry of Education, Culture, Sports, Science and Technology (MEXT) were adopted in 2014, so it gave us a perfect opportunity to expand the existing program. In 2017, the MEXT approved the application of Niigata University together with Hokkaido University for «Program of Globalization in the field of university education (in cooperation with Russia), the creation of a platform for interaction”. We hope advances in the field of medicine and medical care achieved as a result of such unique cooperation between Japan and Russia will greatly contribute not only to the welfare of citizens of both countries, but also to the development of industry and economy. We would like to share experience gained by our university in the sphere of Japanese-Russian medical exchanges and educational programs, as well to describe the prospects for further development.

## Keywords

Medical education • International exchange • Undergraduate students • PhD students • Double Degree program • Globalization • Japan • Russia

## Introduction

Globalization actively changes the content of scientific medical knowledge, influences the processes of its obtaining and understanding by medical staff [1]. It is important to pay attention to those aspects that should be taken into account in the organization of medical education [2]. Though in recent years the number of undergraduate and graduate students who are trained abroad is gradually increasing [3, 4]. Not very many Japanese medical students take part in international exchange programs at this point [5]. In order to increase the number of Japanese medical professionals who can act on the international level, we need to follow the progressive globalization and do our best to make students interested in foreign medicine, as international experience positively influences their careers [6]. So Niigata University aims to foster healthcare professionals with global medical knowledge who can meet all society's expectations [7-10].

Historically Niigata was a gateway of friendship between Japan and Russia. It is still the city deeply connected with Russia, and this is also evident from the fact that there is the Consulate General of Russia in Niigata. The history of exchanges between Niigata University and Russian universities is long and can be traced back to 1992. At that time a member of the House of Representatives Taro Nakayama established the Japan-Russia Medical Exchange Foundation as a humanitarian aid to victims of the Chernobyl accident. So at first, the Endoscopic Training Center was established in Krasnoyarsk and first Japanese experts were sent there. Exchanges with three universities – Krasnoyarsk State Medical University (KrasSMU), Far Eastern State Medical University, Khabarovsk (FESMU) and Pacific State Medical University, former Vladivostok State Medical University (PSMU) – started in 1993, agreements on the faculty level were concluded in 1998. Since that moment,

Niigata University has established close collaboration between Japan and Russia and it has become one of the pillars of its international activity. To date, more than 320 medical students have participated in various exchange programs. In addition, Niigata University has accepted about 70 doctors and nurses from all over Russia, teaching them various advanced medical technologies, including endoscopy.

## Methods

The credit system measures study time and compares learning achievements, helping students easily transfer credits from one institution to another. This idea was originated in the United States of America and introduced to Japan during the post-World War II era. Soviet education system didn't use credits at all and Russia joined the Bologna process only in 2003. Russian universities mainly use ECTS (European Credit Transfer System) which is an important element of the Bologna process. Both countries have peculiarities in education and credit transfer systems that is why it as discussed in detail with Russian side before the project have started.

Full doctoral course in Japan is basically a four-year course, while in Russia it is a three-year course. During the whole study period Russian graduate student has to get 180 credits, while Japanese student has to get 30 credits.

The number of study hours needed to get 1 credit in Russia and Japan is very different. In Russia, 1 credit equals 36 study hours, one study hour is 45 minutes. In Niigata University 2 credits equal 15 study hours, 1 study hour is 90 minutes. In other words, in order to get one credit, Russian students have to study twice longer.

Based on these differences and consultation with the Russian side, mutual understanding on compatible credits was reached.

That is why the following scheme of credit transfer system was accepted for Double Degree Program. The student has to get 30 credits in four years. Niigata University accepts up to 10 credits from the Russian University, so the rest of credits student gets in Japan.

Regular PhD students who stay in Niigata University for the short term have a limit on compatible credits according to the study period.

## Results

### ***G - MedEx project and its management***

As mentioned above, medical exchange with Russia was always one of the outstanding features of our university.

So we decided to step forward to further the development of our relationships. Thus, we submitted two applications for "Program of priority placement of foreign students sponsored by Japanese government" and "Re-inventing Japan program", and they were both adopted by Japanese MEXT in 2014. As for "Priority placement program" only outstanding international students are accepted as government-sponsored students. They study as graduate students; their tuition fees and living expenses are paid. The aim of "Re-inventing Japan" program is to foster young leaders who can cope with recent rapid internationalization of medicine.

Close partnership is very important for bidirectional exchange programs, as it is essential to develop an interaction strategy, to settle differences in academic systems and educational standards [9]. KrasSMU, FESMU and PSMU became our main partners. Thus, we created a bridge between Russia and Japan that helps to expand medical cooperation between two countries. Furthermore, we have created an educational framework to educate «global medical leaders» that will contribute to the advancement of the world medicine [7]. So, we had two projects with different target groups and program content, but with one ultimate goal. Therefore, to achieve mutually potentiating effect, «G-MedEx Project (Globalization and Medical Exchange Project for Career Development of Young Students in Japan and Russia)» was created, with a center that simultaneously manages and evaluates both projects.

First of all, it is necessary to emphasize that these projects are the activities of the entire Niigata University. The «control center» was created under the leadership of the university president and established in the faculty of medicine (Figure 1). It plays a central role in the management of the G-MedEx project. It consists of 4 faculty and administrative staff members, who are involved in project management, student performance management, clerical work, etc. In addition, it is responsible for entire project activation, including «quality assurance» of education and sharing the results with other university faculties. All the members of G-MedEx Control Center can fluently speak Russian or English. The University Steering Committee decides the details of the project in cooperation with the supervising center. In addition, steering committees were established in each of the three Russian universities, and KrasSMU which was selected as the main university with the closest connection with Niigata University. It helped to organize interaction with other Russian universities. The Japanese side and the Russian side jointly manage the project, working closely with staff of the control center. A feedback system that objectively monitors the progress of the project and its results is needed in order to make the project successful. To this end, we have the Internal Evaluation Committee consisting of four



professors from the Niigata University School of Medicine and the External Evaluation Committee consisting of four experts from other universities. Each time we receive an evaluation of our project by experts at annual meetings, we try to improve it.

**Types of exchange programs**

Our project can be divided into «Medical (undergraduate) student exchange» and «Graduate student exchange» (Table 1). Although undergraduate student exchanges are short time exchanges, their aim is to motivate students to study international medicine and to develop future exchanges with other countries. Graduate student exchanges are essential for educating future global medical leaders' of Japan and Russia, as most postgraduate participants work as doctors. Based on the requests from both countries, we create programs that take into account unique characteristics of each university. The main language of all program participants is English. Participants undergo a rigorous selection based on academic performance, English language proficiency and the results of the interview.

A. «Medical (undergraduate) student exchange» includes the following programs.

(1) Summer Exchange Program

It is an exchange program which lasts about 10 days during summer holidays. One academic credit is given after the program is finished.

We receive approximately 7 Russian students a year. Students are given lectures on Japanese medicine and medical care, its present situation. They also have some practical trainings in chosen department and hospital field trips.

We also send about seven second-fourth-year students of Niigata University School of medicine to Russian Universities we have agreements with. It is very important for Japanese students to learn about the level of medicine in other countries. They have the opportunity to choose an internship department in advance in accordance with the desired specialty. Students receive not only theoretical knowledge, but practical as well, studying directly at the patient's bedside.

(2) Medical Research Training Program

Within the framework of this program, we send two third-year students to Russian partner universities every year for two months. There they conduct individual research work under the guidance of local teachers. Upon returning home, they do a poster presentation and receive seven academic credits.

At first this program was not intended to be bidirectional, but in order to meet the needs of Russian partners, it was decided to accept Russian undergraduate students for about a month of training during summer holidays. So, Russian students also have a chance to get some research experience abroad in the field of medicine they are interested in.

B. «Graduate student exchange» also includes a variety of programs

(3) Double Degree Program (DDP)

According to DDP we accept one student from each of three Russian universities. In case of this program, orchestrated efforts of research groups on both sides are needed. Therefore, it was decided that this would be a four-year program, during which the first two years a student studies in Russia, and the second half of the term at Niigata University. The research project is usually discussed in detail by two parties immediately after the candidate's entrance examinations and during his/her studies. Based on the rules of our university, part of the credits received in Russia is transferred to the student according to credit transfer system. The student has to publish at least one basic and one additional article in an international journal in his research field. It is also necessary to prepare an oral presentation of the published article. An article should be approved by the representatives of Niigata University School of Medicine and International Cooperation Steering Committee. Due to the fact that the duration of the postgraduate course in Russia is three years, the student returns for a certain period to Russia to complete necessary official procedures. Certain research themes are decided taking into account the request of the Russian side. They are infectious diseases, lifestyle diseases, community medicine.

(4) Regular PhD Program (RPP)

Participants of the program are graduate university students. They have a short-term internship at a partner university and receive credits according to the credit transfer system accepted. Niigata University has the largest medical facility located on the shores of the Japanese Sea and it is famous for its high medical standards. Therefore, Russian students can have great merits studying at our university even during a short period of time. In order to meet the needs of our partners RPP is quite flexible about topics and period students would like to study in Niigata University. 4 graduate students a year are accepted. This program is very useful for Japanese students as well. The imbalance in the location of medical institutions due to regional disparities and the uneven distribution of the population, especially in the Far East of Russia, will in the near future become urgent problems for Japan. This is connected with the aging of the population and the depopulation of some certain areas of Japan. In addition, Japanese students will be able to learn more about infectious diseases which cannot be widely seen in Japan and it will also improve the training of Japanese medical personnel. Proceeding from the above, it was decided that such topics as infectious, cardiovascular diseases and preventive medicine, will become the most interesting, and also will allow to use strong points of Russian universities. According to our plan two graduate students a year will go to Russia. The study period is flexible from 2 weeks to 2 to 3 months.

(5) Special program for priority placement of foreign students sponsored by Japanese Government

Participants of this program are supported by Japanese government. Every year, Niigata University School of Medicine accepts two PhD students. They study for four years as the Niigata University PhD students to obtain a degree. They carry out scientific research in the field of infectious diseases using advanced research techniques.

### **Support of students**

Students who go to study abroad have a lot of fears and expectations which the university they are attending should think about. They worry about the access to university places, the provision of financial aid, social support, cultural integration, etc. [10, 11]

This is the reason why G-MedEx project provides extensive student support. In addition to full support of the accommodation which is always the greatest concern of foreign students, we always think about health care. The special health care center consisting of several doctors, including a psychiatrist was established in order to support students.

The official language of the project is English, but since 2016 students are offered to attend Japanese language courses to learn Japanese that can be used in everyday life. Furthermore, we invite leading Japanese scientists to our university to give special lectures that also contribute to the deepening of knowledge and a better understanding of Japanese culture.

For Japanese students who plan to visit Russia, orientation events and seminars are held in advance to provide sufficient safety information and caution. In addition, we have organized the «Japan-Russia emergency contact network», which allows us to support students around the clock.

It is also extremely important to support student's career path. A special support system is necessary, as students can actively work as doctors and researchers. The supervising center plans to cooperate closely with the steering committees of the Russian universities and prepare some positions where students can establish themselves after graduation.

We have also launched an alumni association page in Facebook and provided a place for program graduates to communicate freely. They share information with each other and have career counseling.

with our Russian partners several times a year (Faculty Development). We also hold seminars to promote further development of G-MedEx project in Japan and Russia, report on the progress of the project and achievements in the field of education and research. Since 2016, the «Japanese-Russian Medical Symposium» has been held annually with the participation of all three partner universities. This is a very valuable opportunity to talk and discuss various topics related to education and research in the field of medicine, as well as to report on the achievements and results of cooperation.

Within the framework of the G-MedEx project, every two years we hold an event supported by city and prefectural government for citizens of Niigata. The goal is to explain the essence of the project in simple language and to introduce the Russian culture. All activities carried as a part of G-MedEx project are widely covered in brochures, on the project's website and annual reports that are issued at the end of each year. Three Russian universities have been our main partners to date, but G-MedEx project has gradually gained wide popularity and some other Russian medical universities show their willingness to cooperate with us (Figure 3). Therefore, in 2017 we decided to accept students from 3 new universities: St. Petersburg State University, Kazan Federal University and North-Eastern Federal University. The first two universities are located in the European part of Russia, North-Eastern Federal University is located in Yakutsk, the capital of the Sakha Republic, which is known for its great medical facilities. In addition, an exchange with Kazan State Medical University and Moscow State Medical University started in 2018. Expansion of the list of partner universities that are now located all over Russia, and not just in Siberia and the Far East, allows us to learn more about the problems of community medicine faced by universities, for example, regional disparities, and to give impetus to the further development of the project.

In order to carry out exchange programs (such as the Special program for priority placement of foreign students, DDP and RPP) smoothly and effectively, close communication between faculty members is necessary [12]. In addition, in order to reach a higher level of medicine and medical services development in both countries, it is very important to conduct joint international research. Currently, the main focus is on infectious diseases (especially tuberculosis) and Alzheimer's disease. We are confident that the development of joint research will further strengthen the education framework.

The goal of the program for globalization in the field of university education (creation/construction) of a platform, which was mentioned at the beginning, is to create/construct the platform for gathering and exchanging information, as well as accumulating experience of inter-university exchanges between Japan and Russia. In addition, the «economic cooperation plan, consisting of 8 points» was presented at the Japan-Russia Summit in May 2016. «Japan-Russia University Association» which was

## **Discussion**

At the very beginning of two projects, we went to Russia in order to provide sufficient mutual understanding and explain the essence of the interaction, but during the implementation some misunderstandings inevitably happen. In order to prevent them and react quickly, we hold joint meetings

established during Japan-Russia Summit in December 2016 was requested to formulate a concrete action plan.

Together with Hokkaido University we have made the project proposal. It is planned that the universities of both countries, in cooperation with industrial enterprises and local authorities, will contribute to the expansion and development of Japan-Russia relations in the following areas: 'health and medicine', 'urban development', 'cooperation among small and medium-sized companies', 'energy', 'promotion of industrial diversification', 'industrial development of the Far East', 'cooperation on advanced technologies' and "expanding people-to-people exchanges".

In particular, together with other Russian universities, we are planning to create a consortium which will unite stakeholders of both countries. We will participate and work together on human resource development and promotion of the program. Our university became the leader of «health and medicine» section. Besides, Japan-Russia Medical Symposium was held in Vladivostok last year in September. It was also attended by the Deputy Minister of Health of the Russian Federation, the Deputy Minister of Japanese MEXT. Within the framework of the symposium, all presidents of Russian partner universities reported on the results of the project. Furthermore, the establishment of a coordination system between universities was confirmed. So we will be steady in our purpose, organizing various exchange events in the future.

Although G-MedEx is a program specialized in the medical field, we hope that it will be a starting point for a wide range of international exchanges. We hope that using the achievements of G-MedEx project and accumulated know-how in the field of international exchange we will spread our initiative and create a platform, so all our efforts will lead to revitalization of Japan-Russia exchanges. We are looking forward to further deepening of friendship between Russia and Japan.

## Acknowledgements

The authors acknowledge the contribution and assistance of Krasnoyarsk State Medical University faculty members – President Ivan Artyukhov, Vice-president Alla Salmina, Vice-president's assistant Tatyana Konkova, Head of Graduate Department Elena Teplyashina.

## Conflict of Interest Statement

All authors state that there are no conflicts of interests to declare.

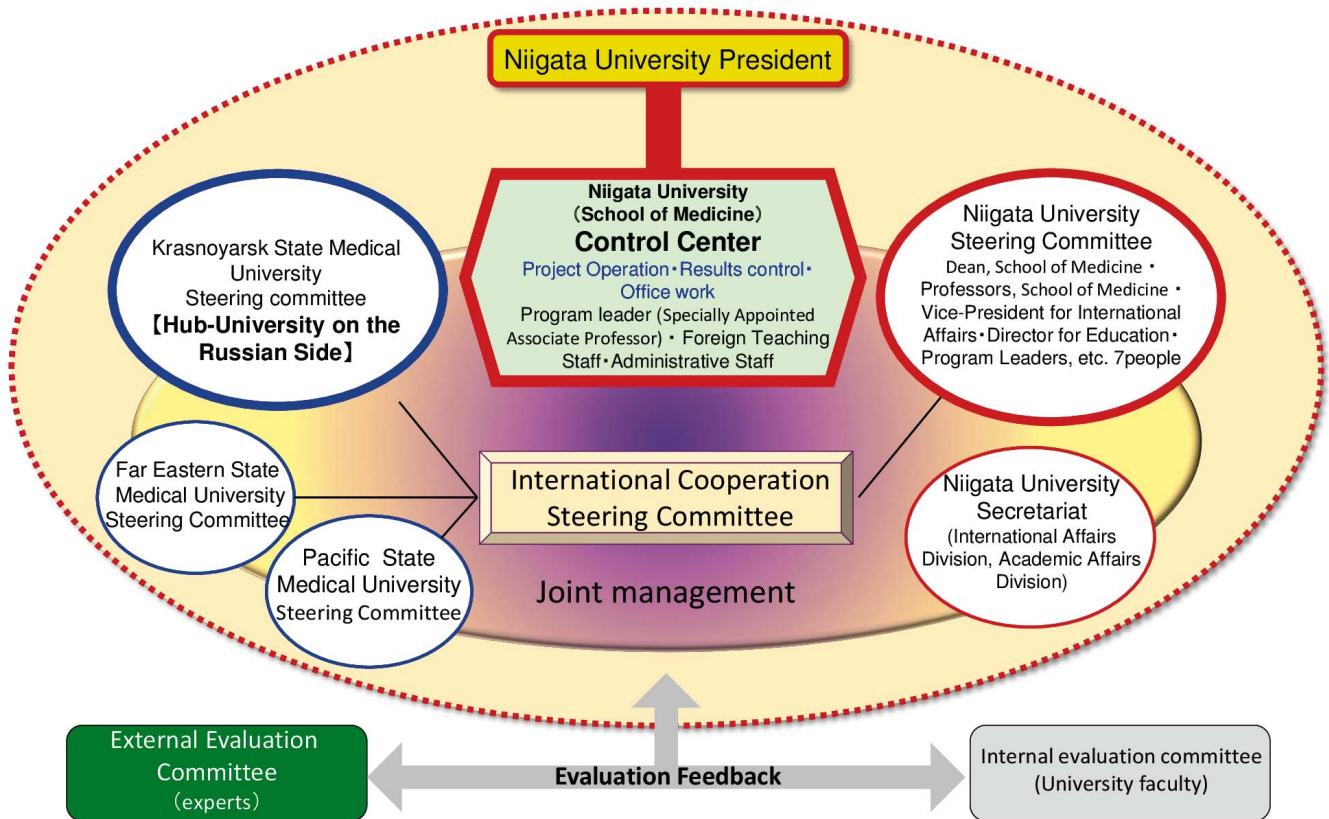
## References

- Bateman C, Baker T, Hoornenborg E, Ericsson U. Bringing global issues to medical teaching. *Lancet*. 2001;358(9292):1539-42. [https://doi.org/10.1016/S0140-6736\(01\)06552-7](https://doi.org/10.1016/S0140-6736(01)06552-7)
- Haupt ER, Pearson RD, Hall TL. Three domains of competency in global health education: recommendations for all medical students. *Acad Med*. 2007;82(3):222-5. <https://doi.org/10.1097/ACM.0b013e3180305c10>
- Suzuki T, Nishigori H. National survey of international electives for global health in undergraduate medical education in Japan, 2011-2014. *Nagoya J Med Sci*. 2018; 80(1):79-90. <http://doi.org/10.18999/nagjms.80.1.79>
- Mutchnick IS, Moyer CA, Stern DT. Expanding the boundaries of medical education: evidence for cross-cultural exchanges. *Acad Med*. 2003;78(10 Suppl):S1-5. PMID: 14557080
- Nishigori H, Takahashi O, Sugimoto N, Kitamura K, McMahon GT. A national survey of international electives for medical students in Japan: 2009-2010. *Med Teach*. 2012;34(1):71-3. <https://doi.org/10.3109/0142159X.2012.638014>
- Ramsey AH, Haq C, Gjerde CL, Rothenberg D. Career influence of an international health experience during medical school. *Fam Med*. 2004;36(6):412-6. PMID: 15181553
- Wallace AG. Educating tomorrow's doctors: the thing that really matters is that we care. *Acad Med*. 1997;72(4):253-8. PMID: 9125939
- Boelen C. Prospects for change in medical education in the twenty-first century. *Acad Med*. 1995;70(7 Suppl):S21-8; discussion S29-31. PMID: 9125939
- Cuellar NG. Study Abroad Programs. *J Transcult Nurs*. 2016;27(3):209. <https://doi.org/10.1177/1043659616638722>
- Huhn D, Huber J, Ippen FM, Eckart W, Junne F, Zipfel S, et al. International medical students' expectations and worries at the beginning of their medical education: a qualitative focus group study. *BMC Med Educ*. 2016;16:33. <https://doi.org/10.1186/s12909-016-0549-9>
- Heck JE, Wedemeyer D. [A survey of American medical schools to assess their preparation of students for overseas practice](#). *Acad Med*. 1991;66(2):78-81. PMID: 1993106
- Rohrbaugh R, Kellett A, Peluso MJ. Bidirectional Exchanges of Medical Students Between Institutional Partners in Global Health Clinical Education Programs: Putting Ethical Principles into Practice. *Ann Glob Health*. 2016;82(5):659-64. <https://doi.org/10.1016/j.aogh.2016.04.671>

**FIGURE LEGENDS**

**Figure 1.** Project management and evaluation system.

Control Center is responsible for «guarantee of quality”, project follow-up and information sharing. Steering committees were established in Niigata University and all three Russian universities. The Japanese side and the Russian side jointly manage the project, working closely with staff of the control center. Internal Evaluation Committee consisting of four professors from the Niigata University School of Medicine and the External Evaluation Committee consisting of four experts from other universities make an assessment during annual meetings.



**Figure 2** Niigata University and eight Russian partner universities.

Partner universities in European Russia: 1-Moscow State University, Faculty of Fundamental Medicine; 2-St. Petersburg State University, Medical Faculty; 3-Kazan Federal University, Institute of Fundamental Medicine and Biology; 4-Kazan State Medical University. Partners in the Russian Far East: 5-Krasnoyarsk State Medical University, 6-Far Eastern State Medical University; 7-Pacific State Medical University; 8-North-Eastern Federal University, Institute of Medicine.





## TABLE CAPTIONS

Table 1 Student exchange numbers, 2017

Student exchange		2015		2016		2017		
Total number	Classification	Planned	Achieved	Planned	Achieved	Planned	Achieved	
	Outbound	11	<b>13</b>	11	<b>16</b>	13	<b>20</b>	
	Inbound	16	<b>19</b>	16	<b>21</b>	20	<b>29</b>	
	Overall	27	<b>32</b>	27	<b>37</b>	33	<b>49</b>	
Program type		Classification	Planned	Achieved	Planned	Achieved	Planned	Achieved
1	Summer exchange program for medical students	Outbound	7	<b>10</b>	7	<b>7</b>	8	<b>12</b>
		Inbound	7	<b>11</b>	7	<b>12</b>	9	<b>18</b>
2	Medical research training program	Outbound	2	<b>1</b>	2	<b>7</b>	2	<b>5</b>
		Inbound	–	–	0	<b>1</b>	0	<b>3</b>
3	Regular PhD program	Outbound	2	<b>2</b>	2	<b>2</b>	3	<b>3</b>
		Inbound	4	<b>4</b>	4	<b>4</b>	6	<b>6</b>
4	Double Degree program	Inbound	3	<b>2</b>	3	<b>3</b>	3	0
5	Special program for priority placement of foreign students	Inbound	2	<b>2</b>	2	<b>1</b>	2	<b>2</b>

✘ Bold numbers-hit target

# INTERACTIVE TECHNOLOGIES OF TEACHING RUSSIAN AS A FOREIGN LANGUAGE FOR MEDICAL STUDENTS

N. Goncharenko<sup>1</sup>

<sup>1</sup>*Department of the Russian Language & Social & Cultural adaptation, Volgograd State Medical University, Volgograd, Russian Federation*

## Abstract

The paper discusses the new interactive technologies in teaching Russian as a foreign language. Based on a review of literature, research, theory, internet resources and current teaching practices the paper considers both theoretical and practical aspects of the usage of interactive technology in teaching Russian as a foreign language for medical students. The author demonstrates that learning Russian plays a vital role for foreign students studying medicine in Russia, being a prerequisite for their educational and professional work performance during their studies in a Russian university. The new modern technologies of teaching such as interactive teaching technologies largely contribute to the increase of foreign students' motivation for learning the Russian language, particularly for medical and biological studies, and the efficiency of the learning process, as well as to the development of an active verbal communication during the classroom activities. Teaching experience demonstrates the effectiveness of interactive technologies for the development of speaking proficiency, interpersonal and communication skills. Based on the theory of teaching practice at a medical university and on the literature review as well, we specified the core characteristics of the interactive technologies compared to the traditional methods of teaching. Our review's results make it possible to suggest that interactive technologies implementation should be based on mechanisms of dialogue, reflexivity and collaboration. These mechanisms contribute to the formation of the communicative as well as professional competence of foreign students.

## Keywords

*Interactive Technology • Russian language • Methodology of teaching • Medical students*

## Introduction

It is evident that a significant place in the education system strengthens the position of any language in the world nowadays. The prospect of a partnership of cooperation with Russia, where Russian is a state language, creates the need for a practical learning of the Russian language by foreigners. This also explains the need for the existing of contemporary export of educational services within the framework of the preparation of specialists for foreign countries.

Currently, teaching Russian as a foreign language has been actively developed as a relevant and promising area. Interest in the learning of the Russian language is constantly increasing worldwide. Every year, more and more foreigners living in Russia and abroad are interested in the Russian language, are willing to learn it and become competent Russian speakers [1, 2].

The grasping of the basics of the Russian language is a prerequisite for the educational and professional work

performance while studying at a Russian university. Increasing foreign students' motivation for learning Russian, particularly for medical and biological studies, searching for methods, techniques and technologies to increase the efficiency of the learning process, and supporting an active verbal communication during the classroom activities is a relevant problem. The solution of this problem requires the use of new teaching technologies [1, 3, 4, 5].

## Methods

The methods of investigation comprised analytical and descriptive methods of the research, theory and current teaching practices review, existing literature & internet resources review, as well as a method of teaching experience review [1-15].

Corresponding author: N. Goncharenko

E-mail: [nat\\_go@mail.ru](mailto:nat_go@mail.ru)

© 2018 Natalia Goncharenko. This is an open access article distributed under the Creative Commons Attribution-NonCommercial-NoDerivs license (<http://creativecommons.org/licenses/by-nc-nd/3.0/>).

## Results

Our review results make it possible to suggest that the use of interactive technologies in teaching Russian as a foreign language for international medical students represents a new methodological approach to the training process organization. Aiming to form students and teachers' personal attitude towards the educational process, this approach is reported to proceed from the mechanisms of dialogue, reflexivity and cooperation, providing educational actors' involvement into the training process and their personal responsibility for its results [3]. Based on the theory of teaching practice at medical universities and on literature review results [1-15], we specified the core characteristics of the interactive technologies compared to the traditional methods of teaching in the following Table.

The analysis of the distinctive features of interactive technologies of teaching Russian as a foreign language demonstrates their compliance with the modern requirements of training, confirms the effectiveness of their usage in the contemporary conditions of training. In simple terms, students can more easily understand and memorize the material they have studied through active involvement in the learning process. Based on this, today, the main methodological innovations are associated with interactive teaching technologies.

## Discussion

In modern psycholinguistics and social psychology, communicative activity becomes the key object of study. There are new psychological and pedagogical theories, which emphasize people's social interaction and collaboration, considered as interpersonal communication. In interpersonal

communication, a person takes on a role, plays it and obtains an idea for how a communication partner perceives it, interprets the situation and coordinates his/her own actions [3, 4]. This interaction leads to the development of the person and his/her creative abilities, as well as the ability to think and be aware of oneself as a special person.

All mentioned becomes very relevant for linguistic training. Regarding this, new technology and forms of teaching foreign languages, particularly Russian as a foreign language, are being elaborated.

Technology is known to be the most effective way to achieve the objectives [2]. Being an integral concept, educational technology is considered as a model of educational activity of a teacher and a student (or a group of students) within preparing and conducting the educational process. New educational technology in language teaching refers to a contemporary stage of development of updated teaching methods and techniques used to form and develop students' communicative competence. Among modern educational technologies, there are interactive technologies based on the active interaction and communication between a student and a teacher and other students (the ability to work cooperatively in a group). They are based on interactionism, which is one of the most popular concepts of modern social psychology [5, 7, 8, 9].

Research indicates that interactive learning technology has been developed since the end of the 20th century in the United States (D. Halpern, C. Temple, D. Steele, K. Meredith) as a universal form of teaching various subjects for students of all ages, and jointly implemented by lecturers around the world [10]. These technologies are successfully used as for traditional model of teaching so in contemporary one, including a foreign language teaching, particularly Russian as a foreign language. The mastering of communication skills and social interactions of foreign students becomes the main goal of the contemporary methodology of teaching Russian as a Foreign Language. The process of communication serves not only as

**Table 1.** Comparative characteristics of traditional learning and interactive technologies:

Features	Traditional forms of teaching	Interactive technologies
<b>Main Subject</b>	Teacher or lecturer is the main subject of the educational process	Students are the main subjects of the educational process
<b>The activity of students</b>	The passive activity of students	High students' activity and interaction
<b>Style</b>	The authoritarian style of interaction	A more democratic style of interaction
<b>Source</b>	The teacher is the main source of information, the only knowledge translator. It is the teacher who decides how and what to study and forms the students' views.	Communication & collaboration are the main parts of the teaching process. The teacher is a partner and coordinator of communication. Openness, interaction of the educational process participants, equality of their arguments, accumulation of joint knowledge, the possibility of mutual evaluation and control.
<b>Forms of classwork activities</b>	Lectures, training exercises, self-paced work, final papers, tests	Individual, pair and group work, project work, role-playing games, work with documents and various sources of information, web-quests, computer technologies

a leading learning objective but also as a means to achieve the learning goal. Due to this approach, communicativity ceases to be a simple phenomenon but becomes an essential principle of the learning process construction. The best option to develop students' communicative skills is collaboration [11]. According to educationalist Ken Robinson, education systems should recognize that "most great learning happens in groups", because "collaboration is the stuff of growth" [12]. Of course, to communicate in any language, learners need to talk to each other. Therefore, language classes are a very natural place to use collaborative learning strategies [13, 14].

Studies have shown that when learners work in groups it leads to their improved achievement, retention of learning and social relationships, as well as increase in their intrinsic motivation. It can lessen the stress of contributing to a whole-class situation and give more time for learners to work at their own pace. Development of collaborative learning skills in university settings helps to get students prepared for their future life and work as part of a team [15]. For example, working on group projects in university settings, the students get prepared for teamwork with common goals and collective, as well as individual, responsibility, which is required in most workplaces.

As our teaching experience shows the main objectives to use the interactive technologies in teaching Russian as a Foreign Language are the formation and development of communicative skills and activity (speaking, writing, reading, and listening comprehension), effective assimilation of educational material, as well as improving and maintaining interest in learning Russian. Using similar technologies in the classroom settings, students can generalize their learning and communicative experience. The primary focus should be on communication skills, collaborative activity and teamwork skills development. Pair work and group work are critical in a communicative classroom. In this process, the language teacher assumes the role of organizer, supervisor and a direct participant of communication, coordinates communication activities of students and helps them.

Interactive teaching technologies require special methods and

techniques of the educational interaction, such as question-answer discussion, search of arguments for different points of view, exchange of opinions, and peer assessment. Interactive educational technologies fully meet modern requirements of training, representing a more democratic approach to training organization, aimed to raise students' intrinsic motivation, develop their personality, their cognitive activity and creativity. Among collaborative learning strategies and interactive learning technology used in our professional practice of teaching Russian as a foreign language, there are: work in pairs or in small groups, the chain, press conference, brainstorming, team games, assignments, linguistic games, puzzles, crosswords, role-playing and simulation games, case studies, project technology, technology of working with medical documents, the tandem method, interactive tours, quests and web-quests, literature and musical compositions, discussions, multimedia and Internet technologies, podcasts, edutainment technology, critical thinking development, contests of reciters / literary conferences, and festivals of Russian speech. These types of work are universal, since they correspond to the different stages of learning and can be used to develop social, cultural, and scientific speech skills.

## Conclusion

The mentioned interactive forms of education are the basis for the development of foreign language communication skills and contribute to the formation of the communicative and social competence of foreign students. Professional teaching experience demonstrates the effectiveness and relevance of the usage of interactive technologies to improve interpersonal and communication skills.

## Conflict of Interest Statement

There is no conflict regarding publication of the article.

## References

1. Kazabeyeva VA. Interactive technologies in teaching practice Russian language for foreign students. *Adv Curr Nat Sci* [Internet]. 2015[cited 2018 Apr 5];1(6):1014-8. Available from: <http://natural-sciences.ru/en/article/view?id=34996> Russian.
2. Kapitonova TI, Moscovkin LV, Schukin AN. *Methods and technology of teaching Russian as a foreign language*. M.: Russian Language Courses; 2009. 309 p. Russian.
3. Valeev AA, Latypova LA, Latypov NR. The use of interactive learning technologies in teaching a foreign language in high school. *IEJME — Mathematics Education*. 2016;11(6):1773-85.
4. Nyyazbekova KS. Interactive technologies of teaching. *Int J Exp Educ* [Internet]. 2015[cited 2018 May 13];3:3-5. Available from: <http://www.expeducation.ru/ru/article/view?id=7793> Russian.

5. Ionova NV, Arsenova MA, Timoshina EI. Interactive technology as a means of developing critical thinking in students. *Eur Sci Rev.* 2014;3-4:75-9. Russian.
6. Gavrilyuk OA. The autonomy-focused approach in higher education: theoretical grounds and practical implications. *Integr Educ.* 2017;21(3):360-70. <https://doi.org/10.15507/1991-9468.088.021.201703.360-370>
7. Brown HD. *Teaching by Principles: An Interactive approach to language pedagogy.* NY: Longman; 2001:1-143.
8. Zamkovaya N, Moiseenko I. Innovative forms of work on the lessons of Russian as a foreign language. Tallinn; 2005:1-145. Russian.
9. Promoting 21st century skills [Internet]. [cited 2018 Apr 5] Available from: <https://www.teachingenglish.org.uk/overview/promoting-21st-century-skills>
10. Halpern D. *Psychology of critical thinking.* 4th int. ed. SPb.: Peter; 2000. Russian.
11. Great Idea: Collaborative activities [Internet]. [cited 2018 Apr 5] Available from: [https://eal.britishcouncil.org/teachers/great-ideas-collaborative-activities?utm\\_source](https://eal.britishcouncil.org/teachers/great-ideas-collaborative-activities?utm_source)
12. Robinson K. RSA animate: Changing Education Paradigms [Internet]. [cited 2018 Apr 15] Available from: <https://www.youtube.com/watch?v=zDZFcDGpL4U>
13. Soosar N, Zamkovaya N. *Interactive teaching methods. Teacher's Handbook.* SPb. : Zlatoust; 2004. Russian.
14. Isaev AA, Isaeva IY. Interactive teaching technologies at the higher education establishment as a means of competence-based approach implementation. *Philol Sci. Issues of Theory and Practice* [Internet]. 2016[cited 2018 Apr 15];4-3:179-81. Available from: <https://gramota.net/materials/2/2016/4-3/51.html> Russian.
15. Schaslyva KO, Tuyakova AE, Abdullina SE. Interactive teaching methods in teacher training. *Young Sci* [Internet]. 2016[cited 2018 Apr 23];6(110):841-3. Available from: <https://moluch.ru/archive/110/26685/>



# MANAGEMENT OF MECHANISM DESIGN AS AN IMPORTANT WAY TO IMPROVE PUBLIC HEALTH

I. Sukhareva<sup>1</sup>

<sup>1</sup>Department of Public Health, V.I. Vernadsky Crimean Federal University, Simferopol, Russian Federation

## Abstract

One of the most important developments of modern economics is the concept of economic mechanism design. Mechanism design is the study of economic mechanisms that produce behaviors in public health. The concept has profound implications for management. Management involves the effective use of mechanisms to change behavior. Public health managers must have a strong background in sociology and psychology, negotiation, finance, economics, organizational theory, and leadership. All managers work with limited resources. Managers must understand finance and economics: budgets, investment in the Health Care system, accountability, investment return, optimization, and decision analysis. This feature creates unique challenges for educating and supporting public health managers. To advance public health management as a profession we must apply the basics of mechanism design to its challenges. Leadership science provides a base for development of managers' personal skills and attributes. Many graduate programs in business management and public administration deal with public health management. Accordingly, application of mechanism design (economic, social and others) in public health management can help managers become more effective. Mechanism design in public health management could provide an important way to improve health of the population.

## Keywords

*mechanism design • staff • managers • graduate programs • Public Health*

## Introduction

Public health benefits come from better preparation and support for managers all over the world. Public health management involves a complex of challenges. It is important to understand and use classic or "first" principles to gain perspective about problems and see new solutions in difficult situations. Mechanism design processes apply classic or "first" principles to public health management challenges [1].

## Results

Understanding of public health issues requires philosophical insight. Health care is unique. It is "public" for the reason. Private markets cannot allocate health care resources efficiently because competitive allocations require homogenous products, perfect information as well as free entry and exit from the markets. Health care must be provided as a public endeavor but it must be efficient as well [2]. This means that institutions of public health are a business and it is definitely a state enterprise. This feature creates unique challenges for educating and supporting public health managers. To advance public health management as a profession we must

apply the basics of mechanism design to its challenges [3]. One of the most important developments of modern economics is the concept of economic mechanism design. In economics, mechanism design is the study of economic mechanisms that produce behaviors [4]. The concept has profound implications for management. At its core, management involves the effective use of mechanisms to change behavior. Accordingly, application of mechanism design (economic, social, and others) in public health management can help managers become more effective [5, 6, 7].

The main principles and mechanisms relate to universal management challenges: individual motivation and behavior, conflict and cooperation, allocation of resources, the way people work in groups and organizations, the meaning of system organization, resistance to change and personal attributes. Fundamental management mechanisms provide tools to deal with these challenges [8].

Motivating people requires state-of-the-art knowledge of psychology, sociology, and group dynamics. Groups and organizations require cooperative collective activity. Conflict in these settings is universal. Public health management requires negotiation skills and other techniques used to

Corresponding author: I. Sukhareva

E-mail: [sukhareva\\_irina@mail.ru](mailto:sukhareva_irina@mail.ru)

© 2018 Irina Sukhareva. This is an open access article distributed under the Creative Commons Attribution-NonCommercial-NoDerivs license (<http://creativecommons.org/licenses/by-nc-nd/3.0/>).

balance conflict and cooperation and use the tension for creative advantage [9].

All managers work with limited resources. Managers must understand finance and economics: budgets, accountability, return on investment, optimization and decision analysis. The “public” aspect of public health management emphasizes the political nature of management as a human endeavor. Effective public health management requires understanding of political processes and mechanisms [10].

Managers operate within constraints established by the system. Organizational theory helps explain how managers may operate more effectively within such constraints. It provides scientific underpinnings for describing why and how individuals resist change and how managers can deal with such resistance [11].

Management requires individual qualities such as character, perspective and leadership. Some of these require experience but aspects of it may be developed. Leadership science provides a base for development of managers’ personal skills and attributes [12, 13].

Universal challenges of public health management provide the basis for development and application of mechanisms to deal with such challenges. Public health managers must have a strong background in sociology and psychology, negotiation, finance, economics, organizational theory, and leadership. Many graduate programs in business management and public administration as well as in public health management require coursework in these areas, but very few programs include all of them [3,14].

Besides, many of these areas are neither particularly well developed nor have been rigorously applied to public health.

Common agreement on core mechanisms for public health managers and structuring in the public health management around them might prompt social scientists and public health academics to focus their research on applying and extending these mechanisms in the public health arena. It makes most sense to explore a question of whether there is an optimal way to provide future public health managers with background experience in the form of internships, residencies or other career development that help enrich experience and perspective. Better understanding of the importance of the relative roles of personal attributes and education could help us structure the public health management better [14, 15].

## Conclusion

All public health managers confront a set of universal problems. Identification and agreement about mechanisms that help managers deal with universal problems can help provide a basis for a universal approach to public health management education as well as extending our knowledge through research. Mechanism design in the public health management can provide an important way to improve health of the population.

## Conflict of Interest Statement

None declared.

## References

1. Foreman SA, Kubyshkin AV, Sukhareva IA. Comparative characteristic questions of Public Health managers in Ukraine and US. *Tavrisheskiy Mediko-Biologicheskiy Vestnik*. 2008;4(11):7-11. Ukrainian.
2. Stolyarov SA, Gossen IE. Management in Healthcare - actual component of modern management. *Mod Probl Sci Educ [Internet]*. 2015[cited 2018 Apr 5];5:11-17. Russian. Available from: <http://www.science-education.ru/ru/article/view?id=22473>
3. Negandhi P, Negandhi H, Tiwari R, Sharma K, Zodpey SP, Quazi Z, et al. Building interdisciplinary leadership skills among health practitioners in the 21st century: an innovative training model. *Front Public Health*. 2015;3:221.
4. Alexander JA, Weiner BJ, Griffith J. Quality improvement and hospital financial performance. *J Organ Behav*. 2006;27:45-8.
5. Coyle-Shapiro JAM, Kessler I, Purcell J. Exploring organizationally directed citizenship behavior: Reciprocity or 'It's my Job'? *J Manag Stud*. 2004;41:56-61.
6. Mark AL. Notes from a small Island: researching organizational behavior in healthcare from a UK perspective. *J Organ Behav*. 2006;27(7):7-9. <https://doi.org/10.1002/job.414>
7. Rabarison KM, Bish CL, Massoudi MS, Giles WH. Economic evaluation enhances public health decision making. *Front Public Health*. 2015;3:164. <https://doi.org/10.3389/fpubh.2015.00164>
8. Kuhlmann E, Burau V, Correia T, Lewandowski R, Lionis C, Noor-degraaf M, et al. A manager in the minds of doctors: a comparison of new modes of control in European hospitals. *BMC Health Serv Res*. 2013;13:246. <https://doi.org/10.1186/1472-6963-13-246>
9. Mansurov V, Yurchenko O, Allsop J, Saks M. Anglo-American and Russian Sociology of Professions: Comparisons and Perspectives. *Knowl, Work Society (Sweden)*. 2004;2(2):341-9.

10. Nembhard IM, Edmondson AC. Making it safe: The effects of leader inclusiveness and professional status on psychological safety and improvement efforts in health care teams. *J Organ Behav*. 2006;27(7):941-66. <https://doi.org/10.1002/job.413>
11. Vezyridis P. Technological Innovation and Change of Nursing Work in an Emergency Department. *Med Sociol Online* [Internet]. 2013[cited 2018 Apr 5];1(7). Available from: <http://www.medicalsociologyonline.org/abstracts/abstracts.php?id=9030099653436148003>
12. Earle S, Letherby G, eds. *The Sociology of Healthcare: A Reader for Health Professionals*. Basingstoke, UK : Palgrave; 2008.
13. Pope C. Computers, Cyborgs, Webs and... medical sociology? *Med Sociol Online* [Internet]. 2014[cited 2018 Apr 5];1(8):96-101. Available from: [http://www.medicalsociologyonline.org/Vol8Iss1/MSoVol8Iss1Art1/8.1\\_Art1.html](http://www.medicalsociologyonline.org/Vol8Iss1/MSoVol8Iss1Art1/8.1_Art1.html)
14. Baroff MB. My leadership engine. *Front Public Health*. 2015;3:137. <https://doi.org/10.3389/fpubh.2015.00137>
15. Yphantides N, Escoboza S, Macchione N. Leadership in public health: new competencies for the future. *Front Public Health*. 2015;3:24. <https://doi.org/10.3389/fpubh.2015.00024>

# ESTABLISHMENT OF THE HEMOVIGILANCE SYSTEM IN AN ONCOLOGY-BASED HOSPITAL OF NEPAL: A NEW STARTING IN THE FIELD OF BLOOD TRANSFUSION IN LIMITED RESOURCE SETTINGS

A. Shrestha<sup>1</sup>, R. M. Shrestha<sup>2,3</sup>, S. Shrestha<sup>4,5</sup>, S. Shrestha<sup>6</sup>

<sup>1</sup>Consultant Clinical Hematologist, Hematology Unit, Nepal Cancer Hospital and Research Center Pvt. Ltd, Harisiddhi, Lalitpur, Nepal

<sup>2</sup>Senior Consultant Pathologist, National Public Health Laboratory, Teku, Nepal

<sup>3</sup>Coordinator, National Bureau of Blood Transfusion Services, Teku, Nepal

<sup>4</sup>Clinical Pharmacist and Research Associate, Department of Pharmacy, Nepal Cancer Hospital and Research Center Pvt. Ltd, Harisiddhi, Lalitpur, Nepal

<sup>5</sup>Lecturer, Department of Biochemistry, Nobel College, Sinamangal, Nepal

<sup>6</sup>Senior Consultant Medical Oncologist, Department of Medical Oncology, Nepal Cancer Hospital and Research Center Pvt. Ltd, Harisiddhi, Lalitpur, Nepal

## Abstract

An access to adequate and safe blood transfusion services is an essential measure of basic healthcare systems. The main purpose of hemovigilance is to enhance the quality and safety of the blood transfusion chains, which are implemented for improving the quality of the blood transfusion chain processes, especially focusing on blood safety. Globally, the framework of hemovigilance is extending as one of the key escalations to the group of the human services administrations, recognizing restructured blood transfusions administrations.

The core objective of this review article is to highlight the objectives of the hemovigilance framework, historical aspects of the hemovigilance framework around the world and the scenario of Nepal. Furthermore, it likewise features the scopes and strategies for implementation of hemovigilance at a hospital. An acceptance and incorporation of the hemovigilance system in an oncology hospital or in any tertiary care hospitals in Nepal can avert the incidence or reappearance of adverse events due to the transfusion identified with the whole transfusion chain process. Globally, including the least developed country like Nepal, the hemovigilance framework must be incorporated and systematized for upgrading transfusion and general society certainty additionally regarding blood and its products. Different strategies must be made for the successful implementation and strengthening the hemovigilance system.

In conclusion, there is an interminable and endless necessity for the effort on hemovigilance; although the rules, regulations, and tools are in place. With the end goal to have a productive hemovigilance framework in the least developed countries like Nepal, an extensive methodology and enormous ideas are required.

## Keywords

*hemovigilance • adverse reactions • blood safety • Nepal • transfusion*

## Introduction

An essential measure of any basic health care system is to have an access to the adequate and safe facilities for blood transfusion services, which remain often life savers on the road to critically ill patients. For the development of every healthcare system, the important factor to be considered is a safe and enough supply of the blood. On the other hand, blood transfusion is also intrinsically accompanied by the risks that vary in severity, from negligible to life frightening occasions [1]. Today, even in developed nations, the greatest hazard to the patient

lies in non-irresistible issues of blood transfusions that cause sickness and demise [2]. Defending threats which is linked with transfusion, beneficiaries have remained a global public health urgency with the appearance of human immunodeficiency virus (HIV) in 1980, which is the root of HIV contagion and over time acquired immunodeficiency syndrome (AIDS) resulting from blood transfusions as a threat to blood transfusion safety [3]. As the hazard of acquiring infectious diseases, the clinical threat of transfusions is asserted basically [4, 5].

With a resemblance to the previously existing term “Pharmacovigilance”, the word “Hemovigilance” was invented in France in 1990. It is derived from the Greek word “*haema*” which means blood and the Latin word “*vigilans*” which means watchful/ paying special attention to/ keep watching. As the term enlightens the aforementioned, the purpose of hemovigilance is to enhance the quality and safety of the blood transfusion chain, first and foremost focusing on the blood safety [6]. As defined by Faber, hemovigilance is “a set of surveillance procedures covering the whole transfusion chain (from the donation of blood and its components to the follow-up of recipients of transfusion), intended to collect and assess information on unexpected or undesirable effects resulting from the therapeutic use of labile blood products and to prevent the occurrence or recurrence of such incidents” [7]. In developed countries, similar to quality systems, reviews and audits, hemovigilance has turned into a vital piece of the Blood Transfusion Service (BTS). Being an important part of the modern health care system, the latter has added astoundingly to the development of the services related to blood and blood transfusion [8].

Globally, the hemovigilance system is evolving as a vital addition to the human facilities care team fetching almost enriched patient care. Starting with the blood donors and blood donation, hemovigilance is one of the continuous and standardized systems for gathering of the data and its analysis and disseminating the outcomes and effects among clinical and public health decision makers [9]. The gathering of information that can be generated on responses taking place during the blood donation, or after the donation of blood, as well as determinations of blood donors to evade the occasion/rehash of such scenes, should be acceptable.

### Objectives of the hemovigilance system

The objective of the hemovigilance framework is to monitor transfusion reactions, to identify risks, to make blood transfusions additional secure, more effective and more proficient, to create awareness among the healthcare professionals, to exhibit the safety of the current system in blood transfusion to the population, to present the risks and advantages of this treatment, to generate evidence-based recommendations, and to show that the issues are outstanding and viably tended to attempt to increase blood safety [10]. In contrast to clinical and epidemiological research on labile blood products, this framework has unexpected objectives [6]. The other objectives are to create linkages at national and international levels.

The ethical aspects of hemovigilance consider benefits identified by keeping away from malpractice, recklessness, and carelessness, blood donor awareness and giving data to both healthcare specialists. The healthcare specialists including medical doctors, nurses, lab technicians, and pharmacists/clinical pharmacists and even the patients are comprised. The ethical aspects of hemovigilance are valuable to the safety of patients and give data on wellbeing as a preventive measure in conceivable instances of the contact [11].

### History of Hemovigilance

Intending to have an arrangement of blood surveillance and hence to bring down the threats related to the transfusion, several hemovigilance systems have been produced and executed in many nations. In 1993, France became the first country to present hemovigilance as a national program with compulsory reporting including surveillance activities incorporating the entire process of transfusion [12]. In 1996, the United Kingdom (UK) presented the first voluntary reporting framework which was a non-dependent, professionally directed hemovigilance system concentrated on learning from adverse events [13]. Even though the hemovigilance systems of France and the UK are different from each other. Many developed nations like Canada and European nations like the Netherlands, Ireland, and Denmark have a prerequisite of voluntary reporting [8]. Afterward, in 1995 the European Council distributed a determination through an objective on the way to enhance open trust in the harmless supply of the blood. Soon the hemovigilance framework progressed toward becoming represented by the legal specialists [9,11]. In other countries, hemovigilance is known by another name. In the United Kingdom (UK), Canada and the Netherlands, hemovigilance systems are known as Serious Hazards of Transfusion (SHOT), Transfusion Transmitted Injuries Surveillance System (TTISS), and Transfusion Reactions in Patients (TRIP), respectively. The Norwegian Haemovigilance System is known as a Troll. It was introduced in the year 2003 as a voluntary and confidential reporting system. The information from entrenched hemovigilance frameworks of different nations, for example, the UK, the Netherlands, Japan, Russia, Switzerland, and the United States of America (USA) has assumed appreciative understanding keen on diverse processes which can be beneficial in an improvement of the blood safety [8]. In the USA, in order to accomplish obligatory reporting requirements or a portion of the safety of patient improvement initiatives, hospital transfusion services report all the different hemovigilance



happenings to federal, state, and non-governmental organizations (NGOs) [14, 15]. In 2004, The Norwegian hemovigilance system initiated a system of reporting which is directed to professional and voluntary systems. In 2007, haemovigilance turned out to be the duty of an expert, according to the European Union (EU) blood instruction, and recording of serious adverse reactions (SARS) and serious adverse events (SAEs) grew into being obligatory [16].

Excluding Japan, which has disseminated the information about antagonistic responses, there is a nonexistence of established hemovigilance framework and inadequacy of hemovigilance information between the Asian countries [8]. One of the essential in the nation is the hemovigilance framework to have an exhaustive way to deal with the addressed matters of antagonistic response succeeding transfusion of blood and its products.

In 2004, South Korea introduced the Korean Hemovigilance Systems for starting the activities for the additional enhancement of safety measures in blood transfusion [17]. In 2012, the neighboring country of Nepal in South Asia, India has launched a hemovigilance program, which is known as Haemovigilance Programme of India and makes a significant portion of a pharmacovigilance program at a nationwide level. With a roadmap of five years with four phases of hemovigilance, i.e., the phase of launching, the phase of expanding and partnership, the phase of development and conservation, and the phase of optimizing, it is an all-inclusive, integrated, and well-structured method [18].

### Scope of Hemovigilance

Due to the regulations in the variety of reporting, the scope of assorted hemovigilance frameworks from the diverse countries reveals an inconsistency, i.e., reporting of adverse reactions versus reporting of adverse events, reporting of all versus reporting serious adverse reactions only; reporting only incidents in recipients or also in donors; reporting all adverse events or only the SARs in recipients [6]. Superlatively, the hemovigilance system needs to buffer strategies wherever all through the entire transfusion chain, from the preliminary donation of blood, passing out of blood, and blood transfusion to patients for the spotting, recording, and exploration of adverse events and responses, and proximate failures or errors identified with the blood transfusion. It ought to be very much fit between the blood transfusion office, hospital's staff (clinical), and transfusion research or laboratories, hospital transfusion boards and the administrative office [19].

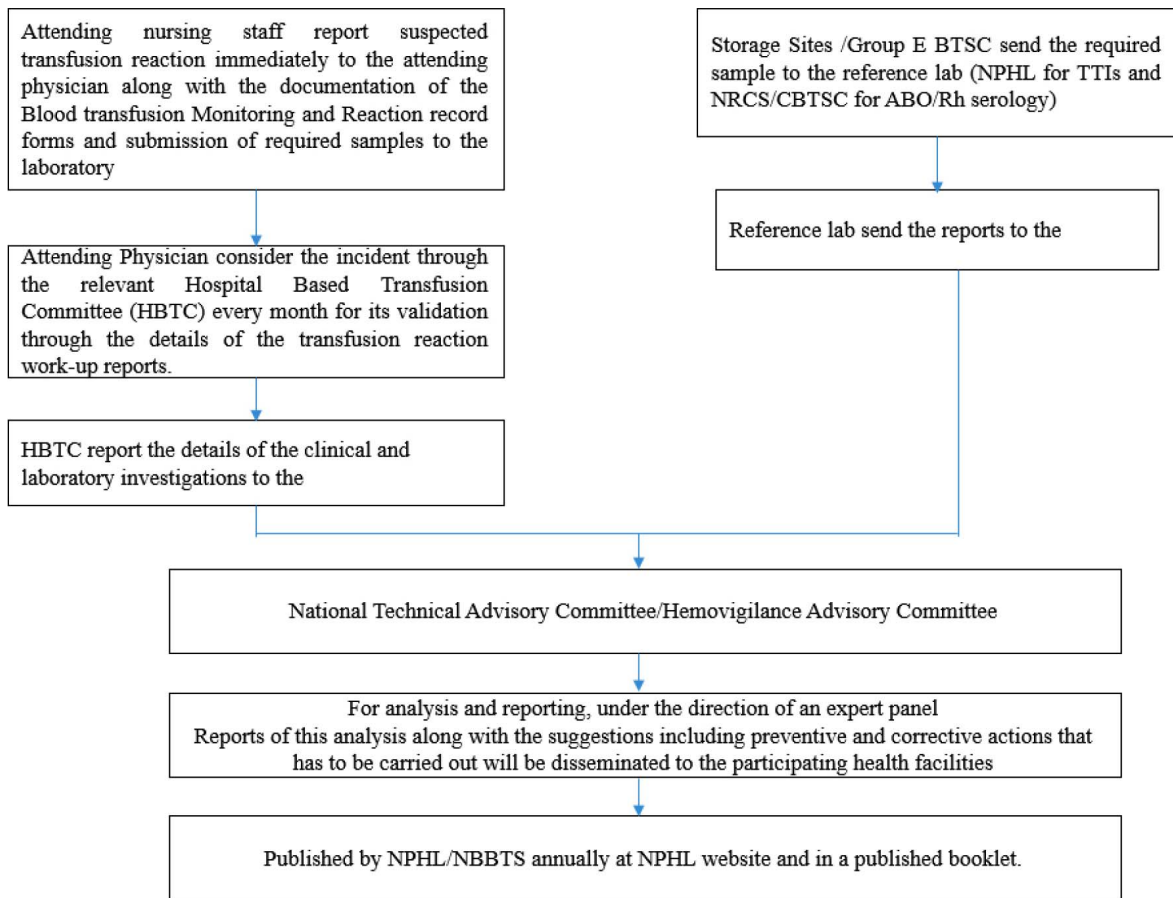
### The Hemovigilance Program in the developing country of Nepal

Following this international development in hemovigilance, National Hemovigilance Reporting Guideline in Nepal was developed in 2017 by the Government of Nepal (GoN) through the National Bureau for Blood Transfusion Service (NBBTS) as a focal point for blood safety on behalf of the Ministry of Health and Population which provides the instructions on procedures covering the entire transfusion chain, their provision for transfusion to patients and their follow-up. The established Hemovigilance Program of Nepal is based on a non-punitive and anonymized approach. For the implementation of the Hemovigilance Program in Nepal, currently four hospitals (two government hospitals and two private hospitals) of Nepal are nominated. One of the nominated hospitals is the Nepal Cancer Hospital and Research Center which is an oncology-based hospital of Nepal. After the pilot study, it will be increased accordingly for the next year. The ultimate goal of the Hemovigilance Program of Nepal is to become a part of the international hemovigilance network. However, the concept of hemovigilance is not well developed in Nepal, the least developed country in South Asia.

### Hemovigilance setup at Nepal Cancer Hospital and Research Center (NCHRC)

An acceptance of the hemovigilance system in an oncology hospital or in any hospitals in Nepal or globally can inhibit the occurrence or recurrence of adverse events related to the entire transfusion chain. Nepal Cancer Hospital and Research Center (NCHRC) which is an oncology based hospital in Nepal follows National Hemovigilance Reporting Guideline in Nepal (2017). All the serious adverse reactions (SARs) are reported that comprise immunological haemolysis due to ABO incompatibility and other alloantibody, non-immunological haemolysis, transfusion-transmitted bacterial infection, anaphylaxis/hypersensitivity, transfusion-related acute lung injury (TRALI), transfusion-transmitted viral infections (HBV, HCV, HIV  $\frac{1}{2}$  and others), transfusion-transmitted parasitological infection (malaria), post-transfusion purpura, graft versus host disease, transfusion-associated circulatory overload (TACO), and febrile non hemolytic transfusion reactions (FNHTR). All these SARs are reported via Form 1 of Blood Transfusion Monitoring Record and Form 2 of Blood Transfusion Reaction Record (Appendix I and II) once the blood is ordered from the blood bank. According to Form 1 conditions of the patient (general appearance of the patient, temperature, pulse, blood pressure, respiration) are monitored before and during the blood transfusion, before

**Figure 1** The organogram of the Nepal Hemovigilance System



the beginning of the transfusion and as soon as the transfusion is in progress every next fifteen minutes. After that every hour up to 4 hours, monitoring of blood transfusion is performed. According to Form 2, different types of the transfusion reaction (fever, chills, rigors or urticaria, pruritis, flushing or hypotension, anxiety, oliguria, renal failure, anaphylaxis, shock, dyspnea, orthopnea, cough, tachycardia and delayed transfusion reactions like fever, decreasing hemoglobin) are noted before beginning the transfusion, as soon as the transfusion is started and after fifteen minutes after the transfusion. After that every hour up to four hours, monitoring of blood transfusion is performed.

The attending nursing staff of the hospital reports the suspected transfusion reaction immediately to the attending physician along with the documentation of the blood transfusion monitoring and reaction record forms and submission of required samples to the laboratory. The attending physician considers the incident through the relevant Hospital Based Transfusion Committee (HBTC) every month for its validation through the details of the transfusion reaction work-up reports. HBTC reports the details of the clinical and laboratory investigations to the National Technical Advisory Committee/Hemovigilance Advisory Committee for

analysis and reporting, under the direction of an expert panel. Reports of this analysis along with the suggestions including preventive and corrective actions that have to be carried out will be disseminated to the participating health facilities. Finally, they will be published by National Public Health Laboratory (NPHL) / NBBTS annually at NPHL website and in a published booklet for public and concerned stakeholders.

### Strategies for implementing hemovigilance at the hospital

There are strategies for the successful implementation of hemovigilance at the hospital which include awareness, education, and training. They are very important to every characteristic of blood safety. Education on hemovigilance can be given in the form of Continue Medical Educations (CME), awareness, lectures, seminars, and symposium, etc. for health care professionals including medical oncologists, doctors, pharmacists, nurses, and even patients. Additionally,

it is necessary to develop a committee on hemovigilance within a hospital to encourage synchronization between the blood users and blood providers. Adequate maintenance of blood transfusion reactions records in the hospital should be done. Learning from the other countries which have already successfully implemented the hemovigilance system in their countries and taking guidance from the countries where this program has already been implemented successfully, but at the same time before the start of this program, we should keep in mind the local conditions of the area.

## Conclusion

In healthcare settings, hemovigilance is considered as a new system which is essential and which has been following by a numerous nation, especially in an emerging country like Nepal. The incorporation of the hemovigilance system in a hospital can improve the patient care, the blood-related safety, and blood transfusions. Hemovigilance is a surveillance procedure for recognized adverse events and also sentinel recording and documenting of unpredicted adverse events which occur during or after the transfusions. Working as a bridge, Hemovigilance develops the safety through benchmarking to encourage superlative practices and by empowering brisk reactions to new threats regarding blood transfusions [21]. However, these days, blood transfusions are particularly harmless, yet obligatory vigilance is required for ensuring appropriate safety use of blood and blood products [11].

In conclusion, there is an interminable and endless necessity for the effort on hemovigilance; although the rules, regulations, and tools are in place, but there is still the prerequisite of beginning the spot-on awareness and alertness system in order to make certain that the measures will be followed and that hemovigilance will help to prevent undesired reactions related to entire blood transfusion chains. With the end goal to have a productive hemovigilance framework globally, an extensive methodology and enormous idea are required. A simplified tool for data collection using standardized instruments at the hospital level and with a good coordination at the national level can bring up effective hemovigilance system within a country. The data and information from that standardized tools can be utilized as a quality marker to screen blood security and furthermore contribute essentially to evidence-based medicine as well as help to bring together different related stakeholders and /or get access to the prevailing blood policies. At the worldwide level, the hemovigilance framework must be encouraged and institutionalized to improve transfusion safety and the public confidence as well. Furthermore, more researches should be conducted in this hemovigilance framework to create a national and international database.

## Abbreviations

AIDS: Acquired Immunodeficiency Syndrome  
 BTS: Blood Transfusion Service  
 CBTSC: Central Blood Transfusion Service Center  
 EU: European Union  
 GoN: Government of Nepal  
 HBTC: Hospital-Based Transfusion Committee  
 HIV: Human Immunodeficiency Virus  
 MOHP: Ministry of Health and Population  
 NBBTS: National Bureau for Blood Transfusion Service  
 NGOs: Non-Governmental Organizations  
 NPHL: National Public Health Laboratory  
 NRCS: Nepal Red Cross Society  
 SARS: Serious Adverse Reactions  
 SHOT: Serious Hazards of Transfusion  
 TACO: Transfusion-associated circulatory overload  
 TRALI: Transfusion-related acute lung injury  
 TTIs: Transfusion Transmissible Infections  
 TTISS: Transfusion Transmitted Injuries Surveillance System  
 UK: United Kingdom  
 USA: United States of America

## Declarations

**Ethics approval and consent to participate** Not Applicable  
**Consent for publication** Not Applicable  
**Availability of data and material** Not Applicable  
**Competing interests** None  
**Funding** The author(s) received no financial support for the research, authorship, and/or publication of this article.

## Authors' contributions

AS and SS (a) visualized the concept and were responsible for writing the manuscript. AS and RMS provided the information regarding Nepal issues. SS (b) reviewed the manuscript and added further information regarding historical aspects. All authors contributed to and approved the final version of the manuscript.

## Conflict of Interest Statement

The author(s) declared no potential conflicts of interest with respect to the research, authorship, and/or publication of this article.

## References

1. Sahu S, Hemlata, Verma A. Adverse events related to blood transfusion. *Indian J Anaesth.* 2014;58(5):543-51. <https://doi.org/10.4103/0019-5049.144650>
2. Hendrickson JE, Hillyer CD. Noninfectious serious hazards of transfusion. *Anesth Analg.* 2009;108(3):759-69. <https://doi.org/10.1213/ane.0b013e3181930a6e>
3. Robillard P, Nawej KI, Jochem K. The Quebec hemovigilance system: description and results from the first two years. *Transfus Apher Sci.* 2004;31(2):111-22. <https://doi.org/10.1016/j.transci.2004.07.005>
4. Giampaolo A, Piccinini V, Catalano L, Abbonizio F, Hassan HJ. The first data from the haemovigilance system in Italy. *Blood Transfus.* 2007;5(2):66-74. <https://doi.org/10.2450/2007.0001-07>
5. Kleinman SH, Busch MP. The risks of transfusion-transmitted infection: direct estimation and mathematical modelling. *Baillieres Best Pract Res Clin Haematol.* 2000;13(4):631-49. <https://doi.org/10.1053/beha.2000.0104>
6. de Vries RR, Faber JC, Strengers PF. Haemovigilance: an effective tool for improving transfusion practice. *Vox Sang.* 2011;100(1):60-7. <https://doi.org/10.1111/j.1423-0410.2010.01442.x>
7. Faber JC. Haemovigilance procedure in transfusion medicine. *Hematol J.* 2004;5(Suppl 3):S74-82. <https://doi.org/10.1038/sj.thj.6200427>
8. Ayob Y. Hemovigilance in developing countries. *Biologicals.* 2010;38(1):91-96. <https://doi.org/10.1016/j.biologicals.2009.10.002>
9. Salmi LR. [Epidemiological support in blood surveillance]. *Transfus Clin Biol.* 1994;1(6):421-4.
10. Callum JL, Merkley LL, Coovadia AS, Lima AP, Kaplan HS. Experience with the medical event reporting system for transfusion medicine (MERS-TM) at three hospitals. *Transfus Apher Sci.* 2004;31(2):133-43. <https://doi.org/10.1016/j.transci.2004.07.007>
11. Williamson LM, Lowe S, Love EM, Cohen H, Soldan K, McClelland DB, et al. Serious hazards of transfusion (SHOT) initiative: analysis of the first two annual reports. *BMJ.* 1999;319(7201):16-9.
12. Andreu G, Morel P, Forestier F, Debeir J, Rebibo D, Janvier G, et al. Hemovigilance network in France: organization and analysis of immediate transfusion incident reports from 1994 to 1998. *Transfusion.* 2002;42(10):1356-64.
13. Stainsby D, Jones H, Asher D, Atterbury C, Boncinelli A, Brant L, et al., Serious hazards of transfusion: a decade of hemovigilance in the UK. *Transfus Med Rev.* 2006;20(4):273-82. <https://doi.org/10.1016/j.tmr.2006.05.002>
14. Linden JV, Wagner K, Voytovich AE, Sheehan J. Transfusion errors in New York State: an analysis of 10 years' experience. *Transfusion.* 2000;40(10):1207-13.
15. Chung KW, Harvey A, Basavaraju SV, Kuehnert MJ. How do hospitals participate in national recipient hemovigilance in the United States? *Transfusion.* 2015;55(4):703-7. <https://doi.org/10.1111/trf.12980>
16. Steinsvag CT, Espinosa A, Flesland O. Eight years with haemovigilance in Norway. What have we learnt? *Transfus Apher Sci.* 2013;49(3):548-52. <https://doi.org/10.1016/j.transci.2013.09.013>
17. Kim S, Kim HO, Kim MJ, Lee SW, Shin YH, Choi YS, et al. Performance review of the National Blood Safety Improvement Project in Korea (2004-2009). *Blood Res.* 2013;48(2):139-44. <https://doi.org/10.5045/br.2013.48.2.139>
18. Bisht A, Singh S, Marwaha N. Hemovigilance Program-India. *Asian J Transfus Sci.* 2013;7(1):73-4. <https://doi.org/10.4103/0973-6247.106744>
19. Jain A, Kaur R. Hemovigilance and blood safety. *Asian J Transfus Sci.* 2012;6(2):137-8. <https://doi.org/10.4103/0973-6247.98911>
20. National Bureau for Blood Transfusion Service. National Hemovigilance Reporting Guideline in Nepal. Kathmandu : Department of Health Services; 2017.
21. Epstein JS. Alternative strategies in assuring blood safety: An overview. *Biologicals.* 2010;38(1):31-5. <https://doi.org/10.1016/j.biologicals.2009.10.009>

**Appendix I**

**FORM 1: BLOOD TRANSFUSION MONITORING RECORD**

Name of the hospital and address, Fax No. and E-mail address
--

**Blood Transfusion Record**

Name of patient: \_\_\_\_\_ Age/Sex: \_\_\_\_\_ Ward/Bed: \_\_\_\_\_  
 Inpatient No.: \_\_\_\_\_ Patient's ABO & Rh: \_\_\_\_\_ Donor No.: \_\_\_\_\_  
 Donor ABO & Rh: \_\_\_\_\_ Date of transfusion: \_\_\_\_\_ Bag No.: \_\_\_\_\_  
 Transfusion started by: \_\_\_\_\_ Time of transfusion: \_\_\_\_\_ Hosp. code No: \_\_\_\_\_  
 Type of blood product transfused: WB , PRC , PRP , FFP , Cryoprecipitate

Conditions of the patient to be monitored before and during the blood transfusion	Before starting the transfusion	As soon as the transfusion is started	After Fifteen minutes	Hourly Monitoring of blood transfusion			
				First	Second	Third	Four
The general appearance of the patient							
Temperature (°F)							
Pulse (/min)							
Blood pressure (mmHg)							
Respiration (/min)							

**The first few minutes of a blood transfusion are crucial.** Therefore, continuous attention needs to be given at least for fifteen minutes and if any reaction is suspected immediately stop the flow, start IV drip, inform BTS Centre, complete the transfusion reaction form, and **follow instructions as given in the next page.**

.....  
 Signature of Physician

.....  
 Signature of Nursing In charge



**Appendix II**

**FORM 2: BLOOD TRANSFUSION REACTION RECORD**

Name of the hospital and address, Fax No. and E-mail address
--

**Blood transfusion records**

Name of patient: \_\_\_\_\_ Age/Sex: \_\_\_\_\_ Ward/Bed: \_\_\_\_\_  
 Inpatient No.: \_\_\_\_\_ Patient's ABO & Rh: \_\_\_\_\_ Donor No.: \_\_\_\_\_  
 Donor's ABO& Rh: \_\_\_\_\_ Date of transfusion: \_\_\_\_\_ Bag No.: \_\_\_\_\_  
 Transfusion started by: \_\_\_\_\_ Time of transfusion: \_\_\_\_\_ Hosp. code No: \_\_\_\_\_  
 Type of blood product transfused: WB , WRC , PRP , FFP , Cryo

Type of transfusion reaction	Before starting the transfusion	As soon as the transfusion is started	Fifteen minutes after the transfusion	Hourly Monitoring of blood transfusion			
				First	Second	Third	Four
• Fever, chills, rigors							
• Urticaria, pruritis, flushing							
• Hypotension, anxiety, oliguria, renal failure							
• Anaphylaxis/Shock							
• Dyspnea, orthopnea, cough, tachycardia							
• Delayed: fever, decreasing Hb							

\*\*In case of a reaction, a comment from the physician:

Signature of the physician

***Instructions to the staff:***

The moment reaction occurs, first stop further transfusion of blood, complete the transfusion reaction report form, and take the following samples, and send with the report to the BTSC for laboratory investigations:

1. For immediate post-transfusion blood samples (1 clotted and 1 anti-coagulated) from the vein opposite the infusion site.
2. Blood culture from a blood bag
3. The blood unit and transfusion set containing residual blood
4. The first specimen of the patient's urine following the reaction
5. Additional samples depending on the patient's condition.

*To be printed on the Reverse of Blood Transfusion Monitoring Record Form  
 Please do attach Lab Investigations Report along with the sample*

# DEVELOPING COMMUNICATIVE COMPETENCE IN STUDENTS OF HIGHER MEDICAL SCHOOLS

V. Zhura<sup>1</sup>, J. Rudova<sup>1</sup>

<sup>1</sup>Department of Foreign Languages with a Course of Latin, Volgograd State Medical University, Volgograd, Russian Federation

## Abstract

Communicative competence has been the central point of a great number of English for specific purposes (ESP) studies. However, its relevance to second language acquisition by medical students and attainability are still to be established as the critical evaluation of the present findings may help to create a valuable inventory for practical use in a classroom. The review set out to explore the present-day concept of communicative competence with regard to ESP teaching and ways of its development in students of medical universities. It analyzed the structure of the concept of communicative competence generally viewed as comprising both linguistic and extralinguistic constituents. Special emphasis was placed on the aspect of enhancing competitive competence through students' involvement in oral communication. One of the most effective ways of developing communication skills in ESP classes in medical schools is exposure to authentic communication using Internet facilities. The videos should be thematically adjusted to the students' professional needs and correlate with their level of linguistic and professional expertise. This approach helps to accomplish a number of teaching goals such as providing students with the information about the framework of speech events iterative in medical and academic spheres, communication patterns used in them, and raising their professional and socio-cultural awareness. It also aims to develop their ability to perform speech activities within a wide range of professional and academic contexts. The review made it possible to identify efficient reproductive and productive teaching methods to be employed.

## Keywords

*communicative competence • ESP • linguistic • psychosocial and socio-cultural dimensions • medical training*

## Introduction

The training of healthcare providers aims to develop a number of skills which will make their professional activities successful and efficient. One of their major counterparts is communicative competence. To date, there has been a lot of controversy over both the implications of this concept and its attainability within the context of medical training. For example, in Russian and some Eastern European medical schools there are two interrelated paths of developing communicative competence. The first involves acquiring various patterns of doctor-patient interaction and evolving the appropriate bedside manner during clinical clerkships. The second is encompassed in second language studies, which is the basic part of the medical curriculum in Russia and a number of Eastern European states. The aim of the present article is to review the current publications to reveal and analyze the ways of developing communicative competence of medical students employed in second language acquisition at different stages of training from undergraduate to postgraduate levels in Russian

universities. Within the scope of this paper we targeted communication skills in spoken medical and academic discourse due to the growing importance of English as the international medium of oral communication in both formal and informal events in the medical and scientific settings.

## Methods

To accomplish the goal set in the paper we used the methods of systematic review and hermeneutic analysis which made it possible to select the relevant studies and perform their critical assessment pertaining to the problem in question. We aimed to analyze research papers published in a variety of countries to assess the relevance of the problem under study and approaches to its solutions in different cultural contexts.

## Results

There has been a lot of debate about the competences required for the speaker to successfully convey and receive verbal messages [1 - 3]. The earlier concept of linguistic competence was later opposed to that of linguistic performance. The former implied the knowledge of the form and meaning of the structured constituents of the language system, while the latter referred to the actual use of linguistic entities in particular situations [4].

These concepts were later complemented by other types of competences extending beyond the domain of the language. They tended to target various aspects of communication. For example, pragmatic competence involves the ability to use the language in the institutional settings selecting and adjusting the linguistic means to a particular context [5]. This competence enables the speaker to set and accomplish objectives relevant to a speech event, to adhere to certain communication patterns appropriate to the situation, etc.

The realization of the role of both linguistic and extralinguistic factors in verbal communication gave rise to the concept of communicative competence. It aimed at integrating various aspects of verbal interaction – its linguistic, psychosocial and socio-cultural dimensions. Other researchers claim that such extension of the conceptual framework of linguistic competence to embrace new aspects of verbal interaction has brought to life a new competence type - interactional competence [6, 7]. It is complemented with context-specific expectations and dispositions about social interaction, social-context-specific communicative events or activity types, conventional behaviours, communication patterns and scenarios as well as prosodic, linguistic, sequential and nonverbal resources to construct speech events. Interactional competence tends to be inherent to person-to-person communication [8]. However, as prospective medical professionals may have to apply communication skills in a variety of spheres – healthcare, academic and research activities, we prefer the term communicative competence as it implies communication targeting both a particular interlocutor and the general audience.

Therefore, we view communicative competence as a broader concept incorporating a number of competences such as linguistic, pragmatic and socio-cultural competences. The earlier mentioned interactive skills covered by the notion of interactional competence are considered as part-and-parcel of the former.

All the above considered, communicative competence comprises several types of knowledge. Along with the knowledge of the language form and meaning, the rules regulating communication within a particular socio-cultural context, and speech patterns typical of it, it also incorporates

the speaker's and hearer's expertise in the field involved. The latter implies the body of knowledge related to a certain socio-cultural or professional context reflected in the interlocutors' world view, or familiarity with the issues the communication centers round [9].

As two parties, the speaker and the hearer, are involved in the communication process, speaking and listening appear to be interdependent activities which can be used to enhance their expertise and develop their communicative competence. This can be achieved through exposure to authentic communication. As there is no opportunity to get involved in actual verbal interaction with native speakers employed in the medical sphere in Russian academic settings, students can gain experience by watching authentic videos posted on the Internet [10].

Careful selection of the topics is essential and should target real life iterative situations occurring in academic or professional spheres. The topics should touch upon a number of issues which can be brought together in two major groups. The first group should comprise speech events medical professionals are recurrently involved in. The second group of topics should focus on the problems which students will repeatedly handle when involved in their prospective professional activities (e.g. working with geriatric and addictive clients in social work and clinical psychology, ways of training medical specialists in Russia and abroad, areas of medicine which are of particular importance today, etc.). All these topics should also correlate with the level of the students' linguistic expertise and the stage of their training.

This approach makes it possible to accomplish a number of teaching goals. Firstly, it helps to familiarize students with the framework of a number of speech events iterative in medical and academic spheres (different types of interviews typical of the spheres of medicine and social work, clinical psychology sessions, physical examination, history taking, delivering information to patients, etc.).

Secondly, students can also get to know and learn a wide range of communication patterns used in various situations of professional medical communication (ways of making polite requests when performing a physical examination, ways of recommending treatment to the patient, etc.). Moreover, students tend to develop and enhance as well as re-evaluate their professional awareness and expertise as they find themselves involved in real life contexts solving professional tasks. This necessarily provides an input into their conceptual and terminological framework required to conduct professional activities.

As students become involved through several channels of communication – auditory and visual, they also receive and learn to process the messages sent by the speakers through their prosody, mimics, kinesics, oculosics, and proxemics which enhances their socio-cultural awareness.

Processing acoustic and visual input activates a number of cognitive mechanisms such as word recognition, parsing and segmentation, semantic processing involving information analysis and synthesis, retrieval, proposition analysis, inference-making, and mapping information, thus promoting their proficiency development [11].

Processed acoustic and visual information becomes a basis for building a communicative framework of a typical event of medical and academic life observed by students in a video format. This framework comprises recognizing an event scenario, role expectations and model verbal and non-verbal behavior, as well as speech inventory consisting of linguistic means (language structures used) together with iterative speech formulas and patterns appropriate in a particular situation. We can illustrate the input which a typical communicative event can provide. When watching a video of a medical encounter, students identify its typical structure as including the stages of problem presentation, data gathering (history taking and physical examination), diagnosis and treatment stages. They also become aware of what happens at each of the stages, of the speech clichés and phrasing appropriate for all participants. Later, they can be involved in the discussion of effective and ineffective communication strategies [12].

Equipped with this inventory, students are ready to pass through the next stage of reproductive lexis and grammar activities at which students are expected to gain fluency in using relevant linguistic structures. Finally, they get engaged in activities promoting speaking or the so called interactive listening [13]. This should be arranged as simulation of real life situations whose framework and linguistic features were learnt from the teaching videos.

Simulation of real life situations can be arranged as discussions, first in small groups when students are encouraged to ask questions, air their views, check for clarification, express support, disagree with statements, paraphrase ideas, and so on. Thus, the teacher may ask the students to compare the layout of the wards demonstrated in the video and the way the surveillance and management of patients is arranged in them with those used in a local clinic.

Another rewarding activity is role-playing [14]. To implement it, students pretend to find themselves in professional contexts and have a variety of professional or academic roles. The teacher provides their class with information about who they are and what they are expected to do. Thus, the teacher can ask the students to act out a panel on drug abuse and addiction. The participants may include a presenter who will provide the information on the current situation in a particular city and journalists who will ask the presenter questions on the details of the report (most abused substances, causes of drug abuse, age groups of drug addicts, risk groups, goals of research-based programs, research conducted, etc.). The

useful phrases and the template of the report should also be provided.

Some other activities may include interviews, brainstorming, making the sound for another video played in a mute mode, information gap, case studies, reporting and storytelling [15]. The described repertoire of the ESP teaching techniques in a medical school classroom is likely to raise linguistic, professional and socio-cultural awareness of prospective healthcare professionals.

## Discussion

The present review focused on the concept of communicative competence and the ways of its development in students of higher medical schools. The notion of communicative competence within ESP context needs to consider not only linguistic but also discourse, psychosocial and socio-cultural dimensions of medical interactions. Therefore, it is currently viewed as the interplay of a number of components – linguistic, sociolinguistic, pragmatic, and discourse types of competence.

The most promising strategy of evolving communicative competence in medical students involves the projection of the knowledge of linguistic structures down onto the professional contexts of their potential use. This approach makes it possible to activate and enhance both their linguistic and communicative awareness. Placing students in various potential professional situations also develops their professional and socio-cultural awareness and expertise as they update information they have and familiarize with the approaches practiced in other countries. Moreover, observing the professional situations and carrying out the activities described above, students feel themselves involved in the virtual exchange of information with their colleagues, which makes them well-motivated and enthusiastic language learners.

## Conflict of Interest Statement

The authors listed immediately below certify that they have no affiliations with or involvement in any organization or entity with any financial interest (such as honoraria; educational grants; participation in speakers' bureaus; membership, employment, consultancies, stock ownership, or other equity interest; and expert testimony or patent-licensing arrangements), or non-financial interest (such as personal or professional relationships, affiliations, knowledge or beliefs) in the subject matter or materials discussed in this manuscript.

## References

1. Vorwerg C. Communicative Competence: Linguistic Aspects. In: International Encyclopedia of the Social and Behavioral Sciences. Amsterdam (The Netherlands) : Elsevier; 2015:294–301. <https://doi.org/10.1016/B978-0-08-097086-8.53042-6>
2. Sun D. From Communicative Competence to Interactional Competence: A New outlook to the Spoken English. *J Lang Teach Res.* 2014;5(5):1062–70. <https://doi.org/10.4304/jltr.5.5.1062-1070>
3. Garcia-Marco F-J. The Relevance of Communicative Competence in the Context of Information Literacy Programs. In: Pathways into Information Literacy and Communities of Practice: Teaching Approaches and Case Studies. Cambridge (Mass.), Kidlington: Chandos Publishing; 2017:135–66.
4. Chomsky N. Aspects of the theory of syntax. Cambridge: Massachusetts Institute of Technology Press; 1965. 247 p.
5. Chomsky N. Rules and representation. New York: Columbia University Press; 2005. 299p.
6. Hall JK, Hellerman J, Pekarek Doehler S, eds. Interactional Competence and development. Bristol, UK: Multilingual Matters; 2011. 274p.
7. Campbell-Larsen J. Interactional competence in second language acquisition. *Kwansei Gakuin Univ Humanit Rev.* 2015;19:265–86.
8. Kasper G, Wagner J. A conversation-analytic approaches to second language acquisition. In: Atkinsom D, ed. Alternative approaches to second language acquisition. London: Routledge; 2011:117–42.
9. Ahmadi A, Bajelani MR. Barriers to English for specific purposes learning among Iranian University students. *Procedia Soc Behav Sci.* 2012;47:792–6.
10. Zhura VV, Rudova JV, Krainikova SA. Listening skills development in information activities mediated by communication in foreign languages classes. In: Language of Medicine: international interacademic collection of research papers in honour of V. F. Novodranova. Samara; 2015:198–203. Russian.
11. Hu G. Cognitive Mechanisms Underlying Second Language Listening Comprehension [dissertation]. Atlanta; 2009[cited 2016 Nov 11]. Available from: [http://scholarworks.gsu.edu/cgi/viewcontent.cgi?article=1011&context=alesl\\_diss](http://scholarworks.gsu.edu/cgi/viewcontent.cgi?article=1011&context=alesl_diss). Doctor of philosophy.
12. Jorgensen M, Witt K. Teaching communications skills to medical students using a reflective teaching method and access to online video cases. *AMEE MedEdPublish* [Internet]. 2016[cited 2016 Oct 27]. Available from: <https://www.mededpublish.org/manuscripts/557> <https://doi.org/10.15694/mep.2016.000116>
13. Sura NA. ESP Listening comprehension for IT-Students as a language skill. *Middle-East J Sci Res (Socio-Econ Sci Humanit).* 2013;13:16–21. <https://doi.org/10.5829/idosi.mejsr.2013.13.sesh.1404>
14. Petrovska V. Teaching creatively in ESP. *J Educ Pract.* 2015;6(17):172–6.
15. Tarnopolsky AN. Idea Sharing: Professionalizing ESP Teaching to University Students through Modeling Professional Interaction in ESP Classrooms. *PASAA.* 2015;50:155–72.



# PRELIMINARY REFLECTION ON CONTENT AND LANGUAGE INTEGRATED LEARNING AS A TOOL FOR TEACHING ENGLISH IN A GLOBALISED WORLD

A. O'Connell<sup>1</sup>, C. Chaplier<sup>1</sup>

<sup>1</sup>LAIRDIL, Université de Toulouse (France)

## Abstract

CLIL has become synonymous with teaching English to non-specialist students in professional and academic (ex. universities) contexts. However, it should not be seen as a unique approach that could be applied to any situation. The present reflection aims to emphasise the importance of social and educational contexts in the shaping of CLIL as a tool for both research and teaching, as a research question. It proposes a plan for research that needs to be collaborative and comparative in its objectives and methodology (action research), which will be followed by the presentation of the expected outcomes.

## Keywords

CLIL • specialised English • contextualisation • comparative approach • action research

## Introduction

Higher education in the 21<sup>st</sup> century has entered a new phase, where universities worldwide are competing for recognition and funding. Their avowed aim is not only to provide knowledge but also to enhance the employability of its alumni. This resulted in the tacit adoption of one dominant language for the transmission of academic content and know-how [1, p. 122] and such role was predominantly given to English, which is now associated to the expression *lingua franca* and is still fast expanding. The present contribution is a reflection that aims to address the following issue: how the globalisation of higher education is carried out through the medium of English, and how it should be assessed in the field of didactic research, starting with the French higher education context.

CLIL (Content and Language Integrated Learning) should not be construed as a universal tool kit for language teachers: it is context-dependent, and varies according to the local institutional conditions, and to the variety of English that needs to be taught (Part 1). One way of assessing the efficiency of CLIL is to carry out a comparative research action in different contexts (countries) and in different branches of CLIL teaching curricula (Part 2). The reflection should ideally show that CLIL influences student motivation in a positive manner (Part 3).

## How CLIL works in France

Since 1999, the Bologna Process<sup>1</sup> has pledged to transform and harmonise the European universities so as to encourage mobility, student participation in the education process, foster the social conditions required to broaden the access to higher education, and promote employability. This paved the way for a two-tier reflection on the development of CLIL: first, the multiplication of syllabi taught through English and open to a wide range of students, and, secondly, the inclusion of foreign language teaching that would comply with the Bologna requirements and the tightening links between all European higher education institutions. For specialists in the didactics of English, the whole issue concerned the objectives of blending content and language acquisition dedicated modules, where language is no longer

<sup>1</sup>The objective of the Bologna Process is to establish a European Education Area - the Upper Bologna Process. Initiated in 1998 by France, Germany, Italy and the United Kingdom during the Sorbonne Declaration, the process developed in 1999 in Bologna around 29 signatory countries. There are now 48 countries, 5600 institutions and more than 37 million students participating in this European adventure. Designed to promote the mobility, readability and attractiveness of the European Higher Education Area (EHEA), the Bologna Process is built around 3 main principles: organise studies in 3 cycles (Bachelor - Master - Doctorate); develop tools for academic and professional recognition (ECTS; Diploma Supplement; EQF (European Qualifications Framework); strengthen the quality approach (<http://www.agence-erasmus.fr/page/Experts-de-Bologne>).

central, but becomes a tool that opens access to knowledge and know-how pertaining to other areas of expertise. In that perspective, researchers such as Taillefer, Hellekjaer & Wilkinson, Hellekjaer & Westergaard, Wolff, Stoller & Grabe [2-7] have shown that, in modules where language acquisition and expert knowledge are treated on a par, both benefit, but these endeavours have not become the norm in higher education. Marsh et al. [8] have shown the strong correlation between teaching and learning, which makes it difficult, even for research purposes, to dissociate language skills from teaching skills involved in the process, because they feed off one another in the highest degree. One positive conclusion [9, p. 22] is that such complex method, sustained by a thoroughly well-thought approach to teaching/learning, does not result in more complicated learning and teaching processes.

Academic interest for CLIL/EMILE (in French : Enseignement de Matières par l'Intégration d'une Langue Étrangère) in France is a relatively recent one, and discussions do not really focus on the qualitative aspect of such a teaching/learning process. Some research papers insist on the risk of marginalising languages in higher education, should CLIL be implemented in a haphazard manner. Besides, there has, to this day, not been any global assessment of foreign language teaching policies nationwide, even though this has recently become one major objective in the granting of chairs and positions of assistant professors in higher education. No major study of students and lecturers' representations in that field has been carried out, so as to identify the needs for a coherent and harmonious public policy on language teaching. English for specific purposes (ESP), in its LANSOD (LANGuage for Specialists of Other Disciplines) aspect, is connected to CLIL, and is situated at the crossroad between language and content. It is thus ideally placed as a transdisciplinary mediator between theory and practice. Consequently, implementing CLIL necessitates a thorough reflection on the major features of teaching and learning processes in a non-specialist context, notably on its objectives, and the role of language teachers involved in LANSOD.

### Field research: the ingredients of a methodology

To start with, a thorough research on the ground should be carried out in the following way: "[...] action research is not so much a research methodology as a way of identifying research projects and priorities. Instead of starting with a "research question" based on previous research and theory, the action researcher starts with a problem with which he or she is faced" [10, p. 263], since "the closer the researcher is to practice, the more difficult the academic position will be" [11, p. 114] through the cycle of action research [11, p. 115]: a problem

on the ground is identified, then reflection starts close to the manner in which Pierre Bourdieu defines it as an activity aiming at providing a necessarily simplified representation of reality through descriptors, focusing on relations between properties, for description, explanation or planning purposes [12].

It would help analyse contextualised situations, organise present knowledge and prompt further action and implementation of the results. This guideline will help to:

- identify basic components whose nature has to be defined or clarified;
- identify interfaces between these components, or "places for interaction";
- investigate the reflexive impact of interactions on the original nature of each component [13].

The focus will be on contextualisation in terms of "scale, level and object" [14], the three elements of contextualisation considered in interaction. As the observation scales used vary, as the levels of social realities aimed at exist and as the types of facts studied are different, a global view can be achieved [14, p. 227]. Here is the proposed framework for field research and investigation:

1. Geographical scale: as researchers and language lecturers, we have easy access to language lecturers intervening in specialised English, to lecturers who teach through English without any particular training to do so in law and science, where some knowledge of subject matter is needed, to students with whom needs assessment can be carried out. This will enable all participants to the present approach to review the local and regional state of the offer of English language.
2. Level of social reality (entailing representations, beliefs, knowledge and needs): as the different practices and representations of the actors in our contexts will be considered, an operation of contextualisation is necessary [14, p. 17-18]. In order to interpret the actors' doings correctly, what the actors involve in their actions (past experiences as competences and dispositions to act, their beliefs) and how each context influences action, and the manner in which it will be taken into account. Then the practices of the actors should be contextualised in global or local contexts.
3. Object: it concerns specialised English in terms of language skills, intercultural competences (which includes the domain of specialised English, of the professional culture in which it is used and of didactic practice [2]). Five poles must be considered and further determined in relation to language and teaching/learning: the learner, the teacher, the domain of specialisation, the context, the language and the culture. When speaking about variables, what matters is not the variables *per se* but the connection between them because it is not obvious [15].

The objective of the research is to shape a common theoretical framework based on a comparative study of the

practice of CLIL in different countries with varied educational contexts and traditions. It is therefore a complex approach: the poles in interaction, the tensions, how the poles react/act on one another, how they are defined in relation to one another. The aim is to discover regularities and recurrences in a multidisciplinary approach, which should be used at a later stage to formulate pedagogical methods that would improve English language acquisition using CLIL.

### Expected outcome

As discussed above, the whole project on CLIL aims to show that it may change teacher and learner's perception of the language class in that it includes a variety of implementations, including project-based learning, an approach that is clearly learner-centred, but that also enables students to acquire methods that do not solely concern language acquisition but skills that are of value in a professional environment. Thus, CLIL blends language and communication skills, within the specialised area of study. This is clearly a shift from a traditional conception of the language class (learning English, for example) to a more inclusive context and objectives (learning through English) that imitates real life situations. In that perspective, our research project should ideally measure how CLIL is an incentive to language skills acquisition; moreover, a comparative survey, using questionnaires, interviews and class observations in at least three universities would also contrast several academic contexts across Europe.

But achieving better competences is only one aspect of the question. Indeed if CLIL can help learners achieve their objectives, it can only be done if it also modifies their awareness of the acquisition process and measure how to bridge the gap between their current level and what they should do to improve it: this way, language acquisition must be distinguished from the acquisition of learning methods and the affective, psychological dimension that influences acquisition [11]. This leads us to the second aspect of the research project, which concerns societal representations about education and foreign language learning and teaching.

### References

1. Truchot C. Europe: the linguistic challenge. Paris (France): La documentation française; 2008.
2. Taillefer G. Teaching a content in a foreign language in the French social sciences context: challenge, observations and implications. *ASp*. 2004;45–46:111–26. <https://doi.org/10.4000/asp.884> French.
3. Hellekjaer GO, Wilkinson R. Trends in content learning through English at universities: A critical reflection. In: Van Leeuwen C, Wilkinson R. *Multilingual approaches in university education: challenges and practices*. Nijmegen : Valkhof Pers; 2003: 81–102.

It would be naïve to consider that language learning only concerns the key players in the classroom, i.e. the teacher and the students. In fact the way we learn and teach is closely dependent on mental representations of what education means to the academic institution, society and “civilisation” at large, from a perspective exemplified by Yves Chevallard's “anthropological theory of the didactic” (ATD). According to this approach, societies exchange, transfer and transform knowledge, data, information, which means that it is essentially didactic. However, each level in the social structure imposes its conditions and constraints on how this knowledge is passed on from one individual to another [16]. In other words, language acquisition does not solely depend on innovative teaching methods like CLIL, but also on the manner in which each country, each academic environment envisages the aims and the methods in that perspective. Given that all the case studies in the project will be based on the observation of CLIL-based teaching and learning, Chevallard's ATD could be completed and compared to Geert Hofstede's theory of the four dimensions of culture [17], which may help distinguish one country from another in terms of cultural, anthropological considerations and mental representations.

### Conclusion

To conclude, what is at stake in the didactics of foreign languages is not only confined to pedagogical considerations, and research in that domain could benefit considerably from the adoption of a multidisciplinary and comparative approach to education, as exemplified by the Council of Europe's interest in CLIL as a teaching resource to develop student and worker mobility across the continent of Europe and beyond.

### Conflict of Interest Statement

The authors have no conflict of interest to declare.

4. Hellekjaer GO, Westergaard MR. An exploratory survey of content learning through English at nordic universities. In: Van Leeuwen C, Wilkinson R. Multilingual approaches in university education: challenges and practices. Nijmegen : Valkhof Pers; 2003:65–80.
5. Wolff D. Integrating language and content in the language classroom: Are transfer of knowledge and of language ensured? ASp. 2003;41-42:35–46. <http://doi.org/10.4000/asp.1154>
6. Stoller F, Grabe W. A Six-T's approach to content-based instruction. In: Snow M, Brinton DM. The Content-Based Classroom. White Plains, NY (USA): Addison-Wesley Longman; 1997:78–94.
7. Grabe W, Stoller F. Content-based instruction: Research foundations. In: Snow M, Brinton DM. The Content-Based Classroom. White Plains, NY (USA): Addison-Wesley Longman; 1997:5–21.
8. Marsh D, Marsland B, Stenberg K. Integrating Competencies for Working Life. Jyväskylä, (Finland): Unicom, University of Jyväskylä; 2001.
9. Gajo L. From non-linguistic discipline to discipline said to be non-linguistic: classroom principles and teacher training. Les Langues Modernes. 2009;4:15–23. French.
10. Riley P. The blind man and the bubble. In: Pemberton R, ed. Taking control : Autonomy in language learning. Hong Kong: Hong Kong University Press; 1996:251–64.
11. Narcy-Combes JP. Didactics of languages and ICTE. Paris (France): Ophrys; 2005. 238 p. French.
12. Bourdieu P, Chamboredon JC, Passeron JC. The profession of sociologist. Paris (France): MoutonBordas; 1968. 430 p. French.
13. Bertin JC, Gravé P, Narcy-Combes, JP. Second Language Distance Learning. Theoretical Perspectives and Didactic Ergonomics. Hershey PA, (USA): IGI Global; 2010. 280 p. <http://doi.org/10.4018/978-1-61520-707-7>
14. Lahire B. Plural World. Paris (France): Seuil; 2012. 393 p. French.
15. Narcy-Combes JP, Miras G. 40 years of modelling in language didactics. Mélanges CRAPEL. 2012;33:25–45. French.
16. Chevallard Y. Fundamental concepts in didactics: Perspectives provided by an anthropological approach. In: Douady R, Mercier A, eds. Research in Didactique of Mathematics, Selected Papers. Grenoble (France): La pensée sauvage; 1992:131–67. French.
17. Hofstede G. Cultures and Organizations: Software of the Mind in Administrative Science Quarterly 38. New York: Johnson Graduate School of Management, Cornell University; 1993:132–4.

# WHAT SHOULD BE THE RESEARCH ETHICS FOR YOUNG RESEARCHERS?

A. Bhusal<sup>1</sup>, S. Gautam<sup>1</sup>, B. Sapkota<sup>2</sup>, S. Shrestha<sup>1</sup>, J. Ferreira<sup>3</sup>

<sup>1</sup>Department of Medical Biochemistry, Nobel College, Sinamangal, Kathmandu, Nepal

<sup>2</sup>Department of Pharmaceutical Sciences, Nobel College, Sinamangal, Kathmandu, Nepal

<sup>3</sup>Department of Management and Economic, Universidade Federal de Lavras (UFLA), Lavras / MG, Brazil

## Main Text

As ethical issues and their violations have been widely reported for a long time in the world, Nepal is not an exceptional country. We try to highlight the different aspects of ethics which can be violated and we also find that there is a necessity for ethics education to all young healthcare researchers from all over the world, especially developing countries. Ethical issues and their violations have been widely reported for a long time in the cross-boundary scenario of the world [1-3]. Infringement of research ethics is mostly committed by young scientists and healthcare researchers and result in emergence of research misconduct victims. Research in the field of healthcare or scientific research is based on trust establishment.

Ethics refers to human conduct insofar as it can be called good or bad [4]. Ethics is not only part of research but also a fundamental part of life perfecting human conduct. Research ethics should concentrate primarily on the principle of altruism with the outcome of relief. The paramount goal of the research is focused directly or indirectly on linking to human. Hence, for the expected results, possible outcomes must be taken into consideration while carrying out research activity. In the health sector, Nepal Health Research Council (NHRC) under the Ministry of Health and Population is mostly concerned with ethical issues in health research and is responsible for ethical approval for conducting research [5].

An increasing number of institutions has led to an increasing number of applicants for various research activities which cannot be managed and monitored by NHRC alone. Hence, it has permitted Institutional Review Committees (IRCs) to review and approve such studies involving human and non-human participants. For collaborative works, particularly multi-national ones, the approval is given by the Ethical Review Board (ERB) of NHRC. However, in case of frequent regime changes due to unstable government, ethical reviews

take longer than required [6]. Declaration of Helsinki by the World Medical Association (WMA) for medical research is of utmost importance for the projects involving human subjects and related samples [7].

The need to avoid duplication of work and to facilitate the acceptance of clinical trial data has led different regions to harmonize standards for good practice in clinical research. Thus, through the International Conference on Harmonization (ICH), with the participation of the European Community, the United States, Japan and the World Health Organization, have developed guidelines standardizing criteria in different areas related to medicines. At ICH, the Guidelines for Good Clinical Practices (GCP) have been established, which establish criteria for planning, implementing, auditing, completing, analysing and reporting clinical trials in order to ensure their reliability. In this sense, health research, especially clinical research, should be considered and conducted according to principles and norms collectively referred to as Good Clinical Research Practice - GCP. The GCP aims to ensure that all clinical and regulatory activities are being conducted to the highest professional and ethical standards, in accordance with applicable regulations. It is used as the basis for the creation of the Informed Consent Term (TCLE) [8]. Good clinical practice (GCP) is the essence of such research activity where not only the outcomes but also the clinical procedures in compliance with the established clinical guidelines are given due preference. Both verbal and written informed consents are received from the participants after the necessary briefing of the objectives of the research to them. The information retrieved will only be utilized for the research purpose and confidentiality will be maintained throughout the research process. All these processes are being



carefully supervised by the protocol of NHRC in Nepal but the systematic approach to research with ethics in the core are yet in the infant stage in Nepal.

In conducting research with human beings, it is important to respect some ethical care issues. These include assessing risks and benefits of conducting the research, respecting privacy and confidentiality of data as well as respecting four principles of human beings. In the Free and Informed Consent Term (TCLE), the researcher must specify the research objectives, limitations, risks, and benefits, leaving the choice of participation free. Originated in the USA, this consent emphasises autonomy, non-maleficence, beneficence, and justice [9].

In order to provide integral autonomy to the research subject, in Brazil, Conep determines the use of the TCLE to the research participants involving the name of informed consent [10]. The TCLE makes explicit the commitment that the researcher undertakes to ensure that no information provided will be divulged without the prior consent of the participant (confidentiality) and that all material collected will remain under professional secrecy (privacy) [9].

Research misconduct means unacceptable practices and prepared with dishonesty and fraudulence, without acceptance of the research ethics, falsification, plagiarism and fabrication of facts while performing the research procedure. Research misconduct is a vulnerable act as this harms social and ethical trust towards science. Promotion of ethical conduct in research is a mutual duty of the academicians, research institutes, and the general public [11]. Plagiarism is another major part of research where misconducts are detected. Plagiarism is the copy of the credentials of one's work and idea without a proper agreement with the respective author [12].

Plagiarism and other types of academic fraud are the subjects of current institutional concerns related to teaching and research. This demonstrates relevance of the topic of ethical integrity in scientific research in academia [4].

The agreement here is meant to be referencing i.e. you must acknowledge to the author by the scientific way of referencing like Numbering Style, Vancouver Style, APA, AMA Style etc. However, placing your own or particular words from previously published articles (i.e., paraphrasing) cannot be called plagiarism. As the writing is based on one's own skills and knowledge, self-plagiarism is absent [13].

Educational institutions should perceive plagiarism as an issue to be faced with pedagogical strategies focused on moral education and promotion of scientific integrity awareness [4].

Since most researchers have the greed of their name in the articles, they are very prone to misconduct research in a country like Nepal which decertifies the quality of research. Research conducted in Nepal is not of higher quality (except

few) due to lack of proper ethical behavior and transparency. Promotion of ethical conduct has been a major problem in developing countries like Nepal due to limited sources. A country like Nepal has lots of cost burdens along with the major problem of publication recognition. Among the factors which play an important role in driving the ethical conduct, there are [14]:

- increasing the number of international, national and local conferences, and symposia regarding ethical conduct would bring some positive results in the Nepalese healthcare research field. Additionally, it will establish a great network between the world healthcare scientists and Nepalese emerging healthcare scientists;
- work with international collaboration in the research field may enhance the knowledge of Nepalese healthcare researchers and provide them with better skills to promote ethical conduct in their works;
- use of professionalism in the healthcare field would be very effective;
- providing special credits for special contribution may uplift the interest and creativity of the contributor;
- implementation of international laws in the field of healthcare would bring revolution in the field.

Ethics education should be the primary subject in any field which may or may not is related to research ideology. Ethics education demotivates all the demoralized and unacceptable research methodologies that degrade not only the quality of research but also the trust of the public. It teaches the value of equality and minimizes error occurring due to the lack of ethics education.

Science lives on its credibility, on which its main reason depends. Thus, with regard to the integrity of the research, the mission of all researchers and institutions committed to advancing science to educate and prevent diseases is to make it less and less necessary to investigate and punish [15].

### List of Abbreviations

AMA	American Medical Association
APA	American Psychological Association
ERB	Ethical Review Board
MOH	Ministry of Health
NHRC	Nepal Health Research Council

### Conflict of Interest Statement

The authors have no conflict of interest to declare.

## References

1. Moreno BAC, Arteaga GMG. Violation of ethical principles in clinical research. Influences and possible solutions for Latin America. *BMC Med Ethics*. 2012;13(1):35. <https://doi.org/10.1186/1472-6939-13-35>
2. De Caterina R, Griffioen AW, Porreca F. Fraud in biomedical research - the role of journal Editors. *Vascul Pharmacol*. 2011;55(5-6): 119–20. <https://doi.org/10.1016/j.vph.2011.09.004>
3. Jaslow R. Red wine researcher Dr. Dipak K. Das published fake data: UConn. CBS News [Internet]. 2012 [cited 2018 Apr 1] Jan 12. Available from: <https://www.cbsnews.com/news/red-wine-researcher-dr-dipak-k-das-published-fake-data-uconn/>
4. Pithan LH, Vidal TR. Academic plagiarism as an ethical, legal and pedagogical problem. *Law & Justice*. 2013;39(1).
5. NHRC. National Ethical Guidelines for Health Research in Nepal and Standard Operating Procedures [Internet]. Nepal; 2011[cited 2018 Dec 21]. 40 p. Available from: [http://nhrc.gov.np/wp-content/uploads/2017/02/National\\_Ethical\\_Guidelines.pdf](http://nhrc.gov.np/wp-content/uploads/2017/02/National_Ethical_Guidelines.pdf)
6. Sharma JR, Khatri R, Harper I. Understanding Health Research Ethics in Nepal. *Dev World Bioeth* 2016;16(3):140–7. <https://doi.org/10.1111/dewb.12109>
7. WMA. WMA Declaration of Helsinki – Ethical Principles for Medical Research Involving Human Subjects [Internet]. 2018 9 July [cited 2018 Dec 21]. Available from: <https://www.wma.net/policies-post/wma-declaration-of-helsinki-ethical-principles-for-medical-research-involving-human-subjects/>
8. ICH Harmonised Tripartite Guideline: guideline for good clinical practice. *J Postgrad Med*. 2001;47(2):121–30.
9. Jager ME, Gonçalves J, Dias AC, Beck CL. Ethics in research with adolescents: A review of the national literature. *Psychol Focus Mag*. 2013;5(5):134–49.
10. De Castilho EA, Kalil J. Ethics and medical research: principles, guidelines, and regulations. *Rev Soc Bras Med Trop*. 2005;38(4):344–7. <http://dx.doi.org/10.1590/S0037-86822005000400013>
11. Smith R. Research Misconduct: The Poisoning of the Well. *JRSM*. 2006;99(5):232–7. <https://doi.org/10.1258/jrsm.99.5.232>
12. Li Y. Text-Based Plagiarism in Scientific Publishing: Issues, Developments and Education. *Sci Eng Ethics*. 2013;19(3):1241–54. <https://doi.org/10.1007/s11948-012-9367-6>
13. Onta P. There is no self-plagiarism [Internet]. 2017 Nov 18 [cited 2018 Apr 9]. Available from: <http://kathmandupost.ekantipur.com/printedition/news/2017-11-18/there-is-no-self-plagiarism.html>.
14. National Academy of Sciences. *Responsible Science: Ensuring the Integrity of the Research Process: Volume I*. Washington DC(USA): The National Academies Press;1992:1–224.
15. Santos LH. On the ethical integrity of research. *Sci Cult*. 2017;69(3):4–5.

# FACTORS RESPONSIBLE FOR DELAYED PRESENTATION AT THE DENTAL CLINIC OF THE FEDERAL MEDICAL CENTRE, BIRNIN KEBBI, NIGERIA

W. Olawole<sup>1</sup>, K. Kanmodi<sup>1-3</sup>

<sup>1</sup>Department of Dental and Maxillofacial Surgery, Federal Medical Centre, Birnin Kebbi,

<sup>2</sup>Dental Clinic, Kebbi Medical Centre, Kalgo,

<sup>3</sup>Cephas Health Research Initiative Inc, Ibadan, Nigeria

## Abstract

**Background:** It is a very sad experience, as a clinician, to see a patient presenting very late at a dental office with complicated oral health-related problems when the initial causal problem is very cheap, easy, and simple to treat. This study aims to determine the factors causing delay in seeking dental treatment among the patients visiting the dental clinic of the Federal Medical Centre, Birnin Kebbi, Kebbi State, Nigeria.

**Methodology:** This study was questionnaire-based survey of 172 non-paediatric patients attending the dental clinic of the Federal Medical Centre, Birnin Kebbi, Nigeria. Data was obtained on their socio-demographic characteristics and the reasons behind their late presentation. Data analysis was done using the SPSS Version 20 Software.

**Results:** Most of the participating patients were males (57.6%), Muslims (73.8%) and of age 16 – 35 years (65.1%). Also, 66.9% of them were from the Hausa tribe, 62.8% were married, and 40.1% had polytechnic/university education. The reasons indicated by the respondents for their delay in seeking early oral healthcare services at our dental clinic were diverse. However, the three most commonly given reason were: busy work schedules, dental anxiety, and preference for traditional treatment options.

**Conclusion:** This study provides evidence of delayed presentation among patients visiting the dental clinic of the Federal Medical Centre situated in the Birnin Kebbi metropolis. This study also identified the reasons for such delays. This study also corroborates other studies in ascertaining that delayed dental visit is a public health and clinical problem in the Nigerian setting. Hence, there is an imminent need to ensure that the public are educated on oral health issues.

## Keywords

*Factors • late presentation • dental treatment • patients • Nigeria*

## Introduction

It is a very sad experience, as a clinician, to see a patient presenting very late at a dental office with complicated oral health-related problems when the initial causal problem is very cheap, easy, and simple to treat. In fact, many patients are forced to eventually visit a dental office for treatment of their poor oral health conditions after all their attempts at getting remedy from 'alternative' forms of dental treatment proved futile [1,2].

The issue of delay in seeking proper dental treatment is a global health problem and scientific research had shown that many factors are responsible for delay in seeking early intervention on oral health-related problems [1-12]. Some of these factors include limited access to qualified dental

personnel, heavy engagements at work, ignorance, stress associated with dental visits, transportation problems, dental anxiety, ignorance, and poverty, just to mention a few [1-12]. In Nigeria, all these aforementioned factors are major factors causing patients' delay in seeking proper oral healthcare [3-6, 9, 10, 12]. Interestingly, there exists a rich body of literature on the factors causing delay in seeking oral healthcare among Nigerian people [3-6, 9, 10, 12]. However, after extensive literature search, authors observed that there is little to no literature on factors causing delayed patient visit at any of the dental offices in Kebbi State, Nigeria: this shows the need to research into this interesting area of study.

Hence, this study aims to determine the factors causing delay in seeking dental treatment among the patients visiting a dental office situated in a public secondary healthcare facility in Birnin Kebbi, Kebbi State, Nigeria. The significance of this study is that the data obtained from this study will provide information on the reasons why patients delay in seeking proper oral healthcare services at this dental office.

## Materials and Methods

This study was a clinical epidemiological study which surveyed a cross section of a sample of 172 patients visiting the Department of Dental and Maxillofacial Surgery, Federal Medical Centre, Birnin Kebbi, Nigeria, from July to October, 2016. This study was conducted under strict compliance with the Helsinki Declaration on health research involving human subjects.

Ethical clearance to conduct this study was obtained from the Research Ethics Committee of the Federal Medical Centre, Birnin Kebbi, Nigeria.

The instrument used for this study was a structured questionnaire which was adapted from similar studies [1,13]. The questionnaire had two sections: sections A and B. Section A obtained information on the socio-demographic characteristics of the participating patients while section B obtained information on the reasons why the participants presented late at our dental office. The criteria for a patient's eligibility to participate in this study were: willingness to participate; clinical evidence (i.e. history and examination findings) of longstanding (more than a 3-week duration) oral health-related problems; and being of age 16 and above as at the period of the study. Only those that gave verbal informed consent were recruited for the study. Data collected was cleaned, coded, and statistically analyzed using the SPSS Version 20 Software. Results from the analyzed data were presented using tables.

## Results

Most of the participating patients (n=172) were males (57.6%), Muslims (73.8%) and of age 16 – 35 years (65.1%). Also, more than six-tenth (66.9%) of them were from the Hausa tribe, slightly more than six-tenth (62.8%) were married, and roughly four-tenth (40.1%) had polytechnic/university education (Table 1).

The reasons indicated by the surveyed patients for their delay in seeking early oral healthcare services at our dental clinic were diverse (Figures 1 to 4). However, the three most commonly given reason were: busy work schedules, dental anxiety, and preference for traditional treatment options.

In the course of comparing the relationship between the age distribution of the surveyed patients with the reasons they gave for delayed presentation at our clinic, we found that “dental anxiety”, “busy work schedule”, “preference for traditional treatment option”, and “delay in hospital environment” were the reasons given by patients within the age of “16 – 20 years”, “21 – 50 and 56 – 60 years”, “51 – 55 years”, and “>60 years” respectively. Also, this observed relationship was found to be statistically significant (p-value=0.012) (Figure 1). Also, in the course of comparing the relationship between gender distributions of the surveyed patients with the reasons they gave for delayed presentation at our clinic, we found that the majority of both genders (i.e. male and female) gave a reason of being busy at work to the factor responsible for their late presentation (Figure 2).

There was also an interesting relationship between the marital status of the surveyed patients with the reasons they gave for delayed presentation, though not statistically significant (p-value=0.069) (Figure 3). In the comparison, we found that “busy work schedule” was the most prevalent reason behind the late presentation of the single, married, and divorced patients, while preference for traditional treatment option was the most prevalent reason for delay in presentation among the widowed patients.

Lastly, there was statistically significant relationship between the level of education of the surveyed patients and the reasons they gave for the delay in presentation (p-value=0.020) (Figure 4). Those patients who had no form of school education (i.e. formal or Arabic school education) predominantly gave “preference for traditional treatment option” as the reason for their delay in presentation, those patients that had primary school/secondary school/polytechnic/university education predominantly gave “busy work schedule” as the reason for their delay in presentation, and those that had other forms of tertiary education gave “family/friend influence” as the reason for their delay.

## Discussion

The issue of delayed presentation at the dental office is a global health problem which needs to be seriously looked into [1,2]. This problem of delay in seeking proper oral healthcare had cost many people heavy losses, of which loss of life is not exclusion [1-18]. Hence, the need for early oral health intervention by dental professionals cannot be overemphasized.

It is quite sad that so many dental patients in Nigeria do present very late at dental offices for treatment after serious complications had already set in [13-18]. Different clinical studies from different geopolitical zones in Nigeria had recorded various reasons

behind the delay of patients' late presentation at the dental office [14-18]. In these studies, it was mentioned that limited access to qualified dental personnel, heavy engagements at work, ignorance, stress associated with dental visits, transportation problems, dental anxiety, ignorance, and financial constraints were the factors causing such delay [14-18].

In our study, we observed that the reasons given by our surveyed patients for the delayed presentation of their oral health problems were somewhat similar to the reasons given by patients in other Nigerian healthcare centers, as mentioned in the preceding paragraph. Interestingly, we also observed that the reasons given by our respondents for the delay vary with their socio-demographic attributes; these attributes were age, gender, marital status, and educational status.

Age distribution was found to have strong association with reasons for delay in clinical presentation among our survey respondents (Figure 1). Dental anxiety was the most common reason for delayed presentation among those respondents whose age fell within the second decade of life. This finding supports the report of Thomson et al, whom in their study reported dental anxiety to be a strong factor militating against early dental presentation among young people [19]. Furthermore, busy work schedule was the most predominant factor responsible for delayed presentation among those respondents in the third to sixth decade of life; the reason why this is so is not far-fetched, since they belong to the working class age groups. Interestingly, the majority of those respondents who were above 60 years presented late to our clinic because they preferred traditional treatment option to clinical dental care. Many of these respondents as referred in the preceding sentence might have preferred traditional care probably because the Nigerian elderly population somewhat have preference for traditional care over clinical care.

The most predominant reason given by both the men and women that participated in this study for their delayed presentation at our clinic was busy work schedules (Figure 2). Similar finding had been earlier reported among dental patients in Taibah, Saudi Arabia [20]. Furthermore, the reason why this was the most predominant factor for the delay among our respondents was because the majority of them belong to the working class age groups.

Marital status was also found to have some associations with the factors causing delay in seeking dental care among our study respondents (Figure 3). In this study, we found that many of the participating widows delayed in presenting at our clinic because they prefer traditional treatment options, unlike those respondents that were single/married/divorced who commonly gave a reason of busy work schedule. Based on the above, we could say that the widowed participants might have preferred traditional means of dental care to Orthodox care probably because of their financial constraints unlike those respondents in other marital status groups (single/married/divorced) whose financial burdens may not be as heavy as the widows.

It is also noteworthy that there exists significant association between the educational status of the respondents and the factors causing their delay in seeking dental care in our clinic. Quite many of those respondents that did not have the privilege to go to school indicated that they did not present early for dental care because they preferred traditional means of dental treatment. However, those respondents that had school education indicated that they delayed in presenting because of their busy work schedules.

However, this study has its limitations. First, this study was single-centre study; it did not survey other dental clinics situated within the Birnin Kebbi metropolis, and other clinics in the neighboring towns. Therefore, it makes it difficult to make generalizations based on this study data. Second, this study was a survey of non-pediatric patients (aged 16 years and above); patients below the age of 16 years were not captured in the scope of this study. Hence, this study did not provide information on the reasons for delayed presentation among pediatric patients. Third, this study was strictly a clinical survey, as our study data was only collected from the patients attending our center; hence data of those individuals in the community setting were not captured.

Based on the above information, we would like to give some recommendations. First, there is a need for the dental professionals to create more oral health awareness among the people living in the Birnin Kebbi metropolis and even Kebbi State, at large. Second, the management personnel of the medical center where this study was carried out need to put in measures to ensure that the people visiting the center for dental care are provided with clinical schedules that are very flexible with their time so as to ensure more patient turn out and reduce the problem of delay in dental presentation at the center. Third, the public need to be re-educated about dental visit and anxiety management in a dental office; this recommendation is made because studies had shown that people tend to have some background anxiety when it comes to visiting a dentist for routine check-ups and dental care [21-25].

In conclusion, this study had provided evidence of delayed presentation among patients visiting the dental clinic of the Federal Medical Centre situated in the Birnin Kebbi metropolis. This study also identified the reasons for such delay. This study also corroborates other studies in ascertaining that delayed dental visit is a public health and clinical problem in the Nigerian setting. Hence, there is an imminent need to ensure that the public are educated on oral health issues.

### Conflict of Interest Statement

This study was self-funded. Authors have no conflict of interest to declare.

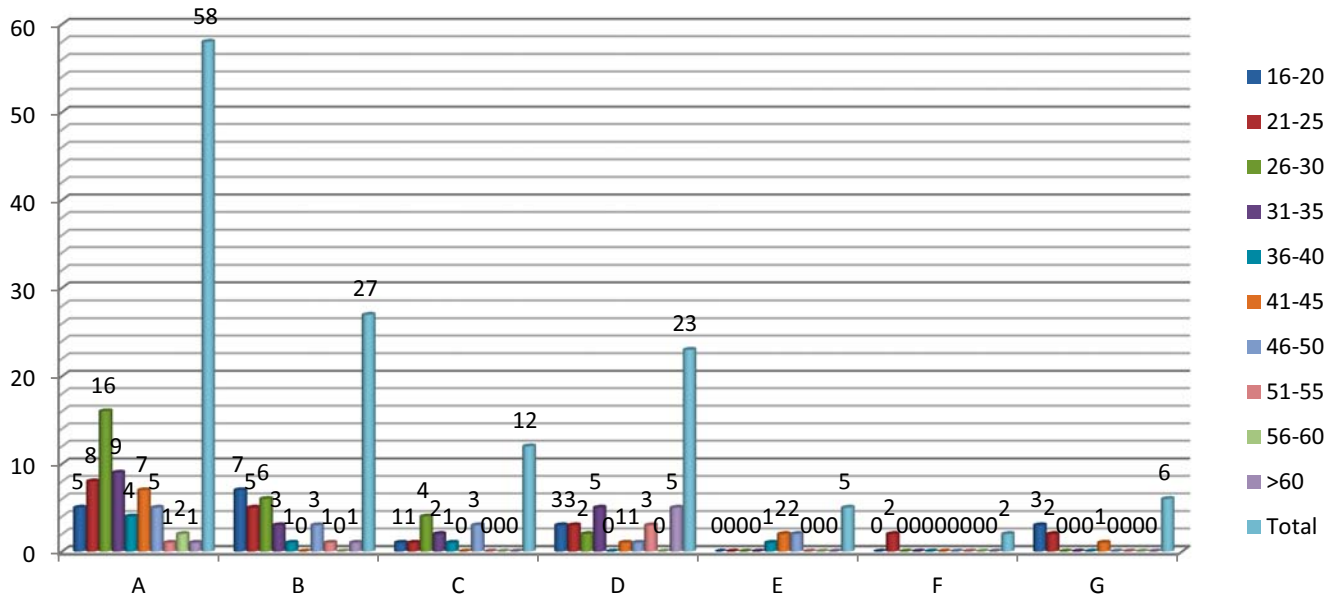
## References

1. Kusekwa M, Kikwili EN. Reasons for late seeking of dental care among dental patients attending dental clinics at School of Dentistry MUHAS, Tanzania. *Tanzania Dent J.* 2011;17(1):7–14.
2. Armfield JM, Stewart JF, Spencer AJ. The vicious cycle of dental fear: exploring the interplay between oral health, service utilization and dental fear. *BMC Oral Health.* 2007;7:1. <https://doi.org/10.1186/1472-6831-7-1>
3. Olusile AO. Improving low awareness and inadequate access to oral health care in Nigeria: the role of dentists, the government & non-governmental agencies. *Niger Med J.* 2010;51(3):134–6.
4. Bashiru BO, Omotunde SM. Burden of oral diseases and dental treatment needs of an urban population in Port Harcourt, Rivers State, Nigeria. *Eur J Gen Dent.* 2014;3(2):125–8. <https://doi.org/10.4103/2278-9626.134838>
5. Akaji EA, Oredugba FA, Jeboda SO. Utilization of dental services among secondary school students in Lagos. *Niger Dent J* 2007;15(2):87–91.
6. Udoye CI, Oginni AO, Oginni FO. Dental anxiety among patients undergoing various dental treatments in a Nigerian teaching hospital. *J Contemp Dent Pract.* 2005;6(2):91–8.
7. Timis T, Danila I. Socio-economic status and oral health. *J Prev Med.* 2005;13(1-2):116–21.
8. Locker D, Ford J. Evaluation of an area-based measure as an indicator of inequalities in oral health. *Community Dent Oral Epidemiol.* 1994;22(2):80–5.
9. Akhigbe KO, Koleoso ON. Trait anxiety, sex, age and dental treatment experience as determinants of dental anxiety among chronic dental patients in Nigeria. *Eur Sci J.* 2014;10(12):316–28.
10. Eroglu CN, Ataoglu H, Kucuk K. Factors affecting anxiety-fear of surgical procedures in dentistry. *Niger J Clin Pract.* 2017;20(4):409–14. <https://doi.org/10.4103/1119-3077.181371>
11. Maggiras J, Locker D. Psychological factors and perceptions of pain associated with dental treatment. *Community Dent Oral Epidemiol.* 2002;30(2):151–9.
12. Patricia A, Opeyemi AB, Micah GO, Emeka CI, Adesida AA. Management of dental anxiety: A survey of Nigerian dentists. *Sahel Med J.* 2014;17(4):159–63. <https://doi.org/10.4103/1118-8561.146822>
13. Anyanechi CE, Saheeb BD. Reasons underlying failure to seek early dental treatment among patients presenting in a Nigeria teaching hospital. *CMS UNIBEN JMBR.* 2013;12(1):37–45.
14. Kanmodi KK, Owoeye OI, Ndubuizu GO. Caregiver reports on the socio-economic and safety issues associated with Sakkiya treatment: a survey of a neglected area in Nigerian healthcare. *Int Public Health J.* 2018;10(2):197–203.
15. Ajayi DM, Abiodun-Solanke IM, Sulaiman AO, Ekhalufoh EF. A retrospective study of traumatic injuries to teeth at a Nigerian tertiary hospital. *Niger J Clin Pract.* 2012;15(3):321–5. <https://doi.org/10.4103/1119-3077.100631>
16. Folaranmi N, Akaji E, Onyejaka N. Pattern of presentation of oral health conditions by children at University of Nigeria Teaching Hospital, Enugu: A retrospective study. *Niger J Clin Pract.* 2014;17(1):47–50. <https://doi.org/10.4103/1119-3077.122836>
17. Eigbobo JO, Etim SS. Trends in dental treatment of children at the University of Port Harcourt Teaching Hospital, Port Harcourt, Nigeria. *Sahel Med J.* 2016;19(4):220–6. <https://doi.org/10.4103/1118-8561.196373>
18. Onyejaka NK, Lawal BN, Okechukwu RA, Osayanda MO, Alamba IC. Pattern of patients' attendance to the dental clinic of Federal College of Dental Technology and Therapy, Enugu, Nigeria. *Pan Afr Med J.* 2018;29:151. <https://doi.org/10.11604/pamj.2018.29.151.14563>
19. Thomson WM, Locker D, Poulton R. Incidence of dental anxiety in young adults in relation to dental treatment experience. *Community Dent Oral Epidemiol* 2000; 28(4):289–94.
20. Alkhalifa NS, Zahran DH. Reasons preventing or delaying dental visits in Taibah University students. *Brit J Med Med Res.* 2016;13(11):23519. <https://doi.org/10.9734/BJMMR/2016/23519>
21. Hittner JB, Hemmo R. Psychosocial predictors of dental anxiety. *J Health Psychol.* 2009;14(1):53–9. <https://doi.org/10.1177/1359105308097945>
22. Scheutz F, Heidmann J. Determinants of utilization of dental services among 20- to 34-year-old Danes. *Acta Odontol Scand.* 2001;59(4):201–8. <https://doi.org/10.1080/00016350152509201>
23. Skaret E, Raadal M, Berg E, Kvale G. Dental anxiety and dental avoidance among 12-18-year olds in Norway. *Eur J Oral Sci.* 1999;107(6):422–8.
24. Smith TA, Heaton LJ. Fear of dental care: are we making any progress? *J Am Dent Assoc.* 2003;134(8):1101–8.
25. Appukuttan DP. Strategies to manage patients with dental anxiety and dental phobia: literature review. *Clin Cosmet Investig Dent.* 2016;8:35–50. <https://doi.org/10.2147/CCIDE.S63626>



**Figure Legends**

**Figure 1.** Column chart showing age (in years) distribution of patients with the reasons given for delay in presentation at the dental office

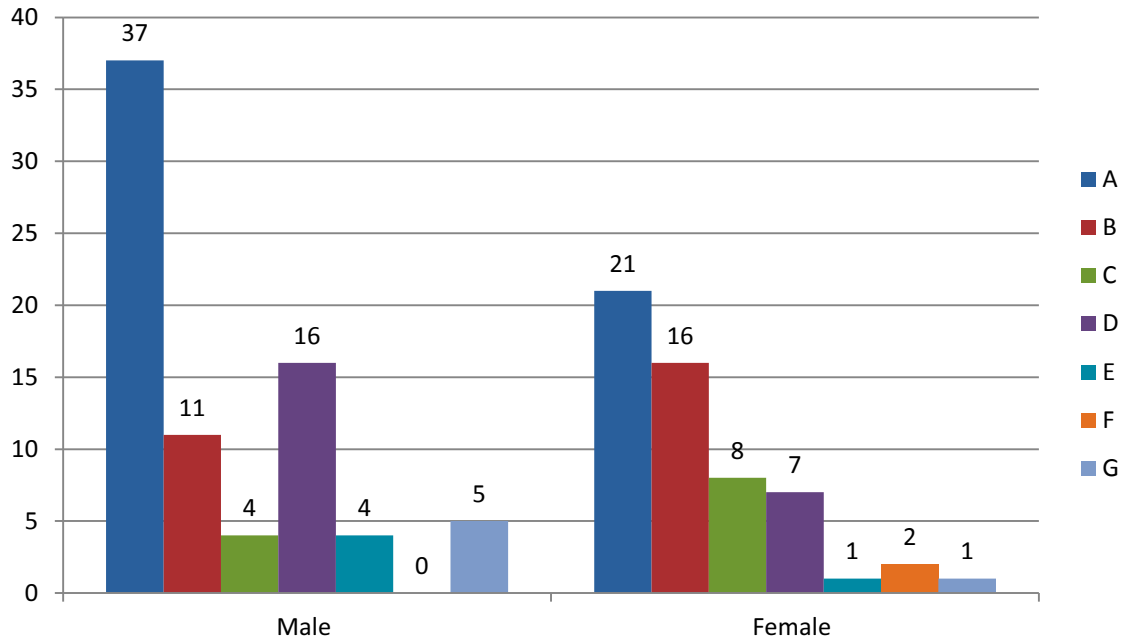


(Chi<sup>2</sup> p-value=0.012; Only those participants that indicated both their age and reasons for delay in dental visit were computed in this statistics)

**LEGEND**

- A = Busy at work, far distance;
- B = Fear of dental treatment;
- C = Previous dental experience;
- D = Prefer traditional treatment;
- E = Delay in hospital environment;
- F = Financial constraints;
- G = Family or friends advised me not to come to hospital

**Figure 2.** Bar chart showing gender distribution of patients with the reasons given for delay in presentation at the dental office

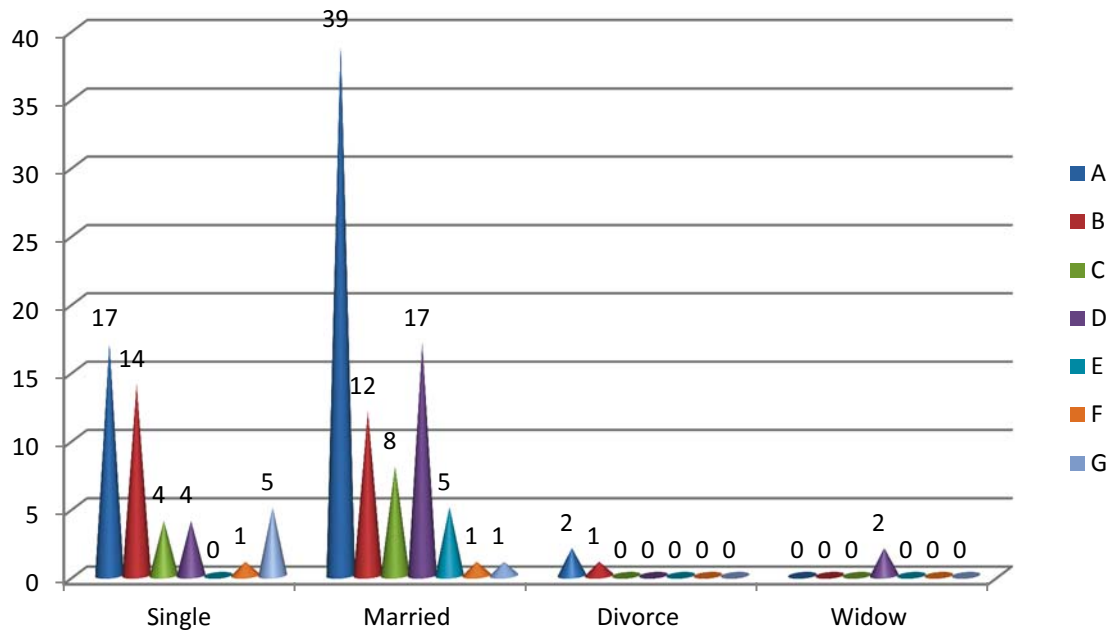


( $Chi^2$  p-value=0.033; Only those participants that indicated both their gender and reasons for delay in dental visit were computed in this statistics)

**LEGEND**

- A=Busy at work, far distance;
- B=Fear of dental treatment;
- C=Previous dental experience;
- D=Prefer traditional treatment;
- E=Delay in hospital environment;
- F=Financial constraints;
- G=Family or friends advised me not to come to hospital

**Figure 3.** Cone chart showing marital status of patients with the reasons given for delay in presentation at the dental office

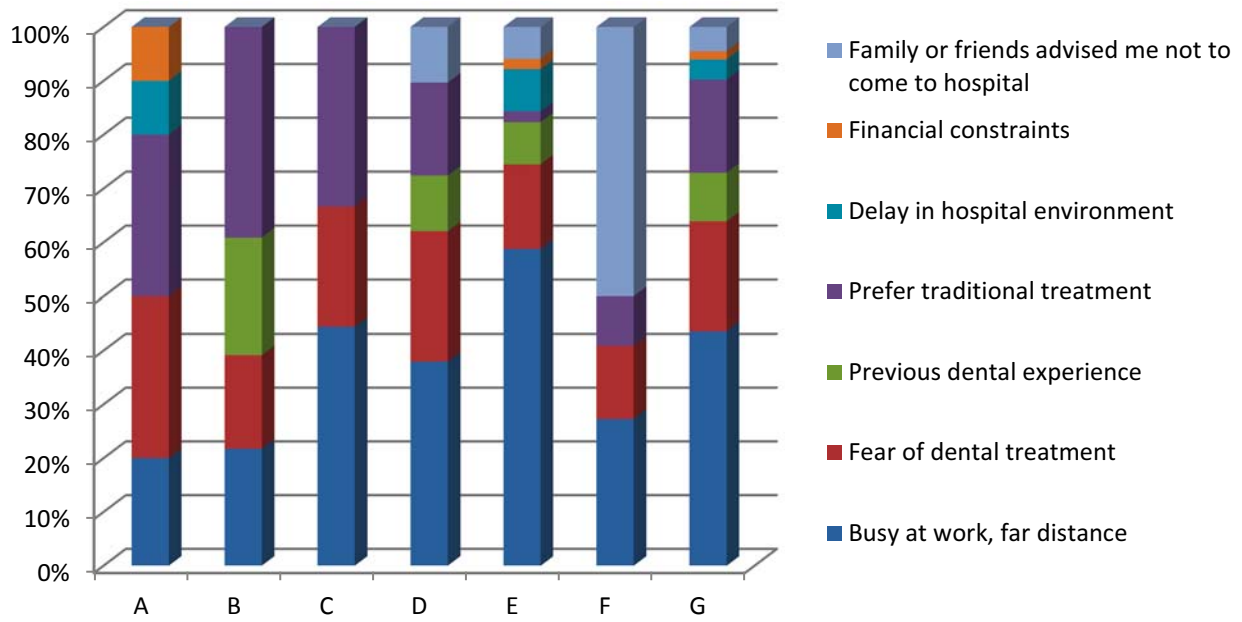


(Chi<sup>2</sup> p-value=0.069; Only those participants that indicated both their marital status and reasons for delay in dental visit were computed in this statistics)

**LEGEND**

- A = Busy at work, far distance;
- B = Fear of dental treatment;
- C = Previous dental experience;
- D = Prefer traditional treatment;
- E = Delay in hospital environment;
- F = Financial constraints;
- G = Family or friends advised me not to come to hospital

**Figure 4.** Stacked column chart showing level of educational status of patients with the reasons given for delay in presentation at the dental office



( $\chi^2$  p-value=0.020; Only those participants that indicated both their level of educational status and reasons for delay in dental visit were computed in this statistics)

**LEGEND**

- A=None;
- B=Arabic;
- C=Primary school;
- D=Secondary school;
- E=Polytechnic/University;
- F=Other tertiary institution;
- G=Total

**Table Captions**

**Table 1.** Socio-demographic characteristics of participating patients

<b>Characteristics</b>	<b>Frequency</b>	<b>%</b>
<b>Age</b>		
16 – 20	20	11.6
21 – 25	30	17.4
26 – 30	38	22.1
31 – 35	24	14.0
36 – 40	11	6.4
41 – 45	12	7.0
46 – 50	17	9.9
51 – 55	8	4.7
56 – 60	3	1.7
>60	8	4.7
Not specified	1	0.6
<b>Gender</b>		
Male	99	57.6
Female	72	41.8
Not specified	1	0.6
<b>Marital status</b>		
Single	58	33.7
Married	108	62.8
Divorced	3	1.7
Widowed	2	1.2
Not specified	1	0.6
<b>Educational status</b>		
None	12	7.0
Arabic	28	16.3
Primary school	11	6.4
Secondary school	34	19.8
Polytechnic/university	69	40.1
Other tertiary institution	16	9.3
No response	2	1.2

# USING SOCIAL MEDIA FOR EFFECTIVE HEALTH CARE SERVICE DELIVERY: BIBLIOMETRICS AND SOCIOMETRY

S. Shrestha<sup>1,2</sup>, J. Ferreira<sup>3</sup>, A. Galti<sup>4</sup>

<sup>1</sup>Department of Pharmacy, Nepal Cancer Hospital and Research Centre, Harisiddhi, Lalitpur, Nepal

<sup>2</sup>Nepal Health Research and Innovation Foundation, Nepal

<sup>3</sup>Department of Management and Economic, Universidade Federal de Lavras (UFLA), Lavras/MG, Brasil

<sup>4</sup>Department of English, Yobe State University-Damaturu, Yobe State, Nigeria

## Abstract

**Background:** Today, social media seems to be a common forum for sharing information, discuss ideas and knowledge. The number of social media users are at increasing trend even in developing countries. The importance of using social media, especially in delivering healthcare services information, include the creation of awareness and firsthand information of health and health-related issues (effect of adverse drug reactions, reporting, among others).

**Purpose:** The main objective of this work is to outline and discuss the opportunities and challenges of using social media in the health area. Specifically, the objectives of this paper are to compare the role of health professionals and consumers with special reference to social media; detect the validity of the information available in social media, and understand how to deal with incorrect/false information, and to analyze the main characteristics of the publications on the subject social media in healthcare.

**Methods:** This article is a narrative review, also a descriptive quantitative research, using the techniques of bibliometrics and sociometry in order to obtain information relevant to the subject in question.

**Results:** The results presented the countries, researchers and universities that produced the most on the subject, and demonstrated the efficiency of bibliometrics and sociometry techniques for health research, going beyond a narrative review.

**Conclusion:** It is concluded that social media is a competitive differential in the provision of health services. To this end, institutions should empower their employees, encourage them to seek and convey reliable and accurate information, monitor routines, and evaluate results through user feedback.

**Suggestion:** To this end, institutions should empower their employees, encourage them to seek and convey reliable and accurate information, monitor routines, and evaluate results through user feedback.

## Keywords

*Social Media • Healthcare • Sociometric • Bibliometric*

## Introduction

In the actuality, there is a evident transformation in how people access and share information. The advancement of digital technologies, specifically social media, brings with it a challenge for healthcare providers, tailoring their professional communication to meet users' expectations for reliable and accurate information. There is a broad definition of social media, which is constantly evolving. The term generally refers to the online tools that enable communication, interaction, and sharing of information, images, videos between individuals and society in real time [1-5]. With regard to health care, the use of web communication, collaborative technologies, and social media are increasingly becoming of great interest, as the

way people communicate has changed; of particular importance, the way users and healthcare professionals transformed and interact. Digital technologies can be used by health professionals for various purposes: to exchange experiences among colleagues; update with daily news and scientific research; feedback to users and patients; as well as, seeking information about health and health-related matters, advise, opinion, among others purposes [6]. There seem some identified challenges for the efficient use of social media in the health area. Moreover, understanding how they're being used by health professionals and users becomes critical. Because the use of social media today is one of the fastest means of communication and easy



interaction. Despite the importance of social media, users should try to identify and validate the information available in social media and understand how to deal with incorrect or false information. Since some users may employ this means to spread fake or false information, which may have negative effects on general users. Therefore, this paper is aimed at identifying and discussing the opportunities and challenges of using social media in healthcare service delivery. Specifically, the objectives of this paper are to compare the role of health professionals and consumers with special reference to social media; detect the validity of the information available in social media, and understand how to deal with incorrect/false information, and to analyze the main characteristics of the publications on the subject social media in healthcare.

### The Relevance of Social Media for Healthcare

It is notable that the advance of digital technologies and social media are in full improvement and continuous expansion. Thus, health service providers must take advantage of and adhere to these advances in order to meet the needs and expectations of users [7]. In Netherland, the Internet has become the main source of health-related information for people. Almost 25% of the population wants to communicate through social media channels with their doctor. The health care services seem to reach a greater percentage of the population with the help of social media. In this sense, health professionals need to adapt and facilitate interaction with their patients with emergent online media [6]. Though, the number of health practitioners using technology to provide professional health services could be said to be on the growth, especially in the developing countries. However, most of United States' professionals have fully employed the use of technology not only in exchanging and sharing information but also interacting with other professional colleagues in discussing cases; teaching courses; exchanging experiences about the health segment; and mainly, to take high-level decisions, such as the preparation and issuance of diagnosis [8]. Interestingly, with social media as a means of communication, the routine of the doctors has changed and the means for communication and interaction with their patients also changed. In addition, how information and experiences are exchanged between professionals, through social networks, blogs, instant messaging, and video sharing, equally made easy. With this transformation, new opportunities have been opened, because it allows for the exchange of information in real time, which is independent of distance [9]. Affirming this position, Smailhodzic, et al. [10] maintain

that the use of social media can greatly assist users in both accessing information at any time and space. Therefore, patients may likely prepare using the platform rather than the face to face interaction with doctors. Considering the effect #LCSM (Lung Cancer Social Media hashtag) created in creating awareness, the use of social media and other electronic means of spreading health and health-related information cannot be overemphasized.

Doctors can have a video conference and/or meeting and release first-hand and instant information [11]. One could conclude that the evolution of the Internet contributes to the expansion of personal health information, with a growing trend. People are posting such information in the public domain, for example, in discussion forums. The availability of information, among them information on diseases and treatments, on the WEB has positive consequences. Hence, the individuals (patients) are better informed now and empowerment of the patients becomes a reality nowadays [7]. As such, the relevance and usefulness of social media for physicians in order to disseminate health information and publicize their services in today's world are glaring. But there are problems and threats in the use of social networks that may negatively impact users and health professionals. This implies that precautions must be taken, to ensure privacy considering the legal aspects of sharing and exchanging health-related information [12]. Many healthcare providers express concerns over the use of social media in practice, particularly, interactions with patients have some ethical issues. However, the use of social media may not be unethical if ethical principles are followed and observed [13].

At the organizational level, health institutions have not yet fully assimilated or adhered to the shift towards public social communication, much less accompany legal and ethical issues. However, it is not an easy task to take advantage of the benefits and minimize the threats and downsides [9]. While it is essential to take into account legal, ethical and professional principles in the use of social media, it is equally paramount to state how relevant and useful sharing information through social media is, if they are reliable and true [13].

### Methods

This is a descriptive, quantitative research using the techniques of bibliometric and sociometry in order to obtain information about the main features of publications on the subject: countries, institutions, authors, authorship networks and co-authorities, among others. It is also a narrative review highlighting the benefits of social media in healthcare.

For data collection, we searched for the recent and relevant publications on the researched topic, specifically in the Web of Science - WOS database. The search strategy includes: the use of the keyword "Social Media in Health Care", delimiting the search in the title of the manuscripts, only articles, between the periods of 2009 to 2018. In order to increase the number of publications, papers that cited these 16 articles, totaling 269, were included, which served as a theoretical basis for our research.

Data analysis was carried out through a quantitative approach. Also, the authors employed the use of the following software: Citespace, VOSviewer, and UCINET 6.0, whose objective is to build social networks of the main characteristics of the publications on the subject in question.

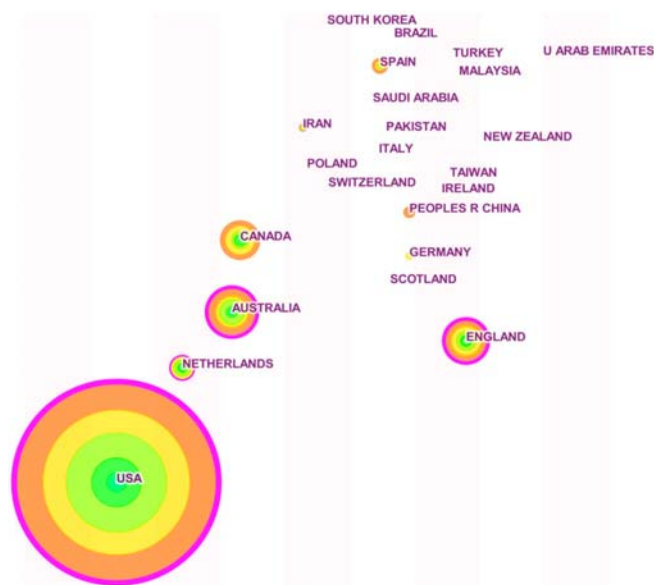
## Results

To meet the objectives of this study, the main features of the publications on the subject were described initially and analyzed the international publications in the WOS database as presented below.

A total of 269 publications were used, as described in table 1, which will serve as the basis for the results and discussion.

## Analysis of publications on the Web of Science Base

In order to understand in which countries, institutions, and authors who are researching about social media in health care, the main publications were searched at WOS and the results are presented in figure 1-4.

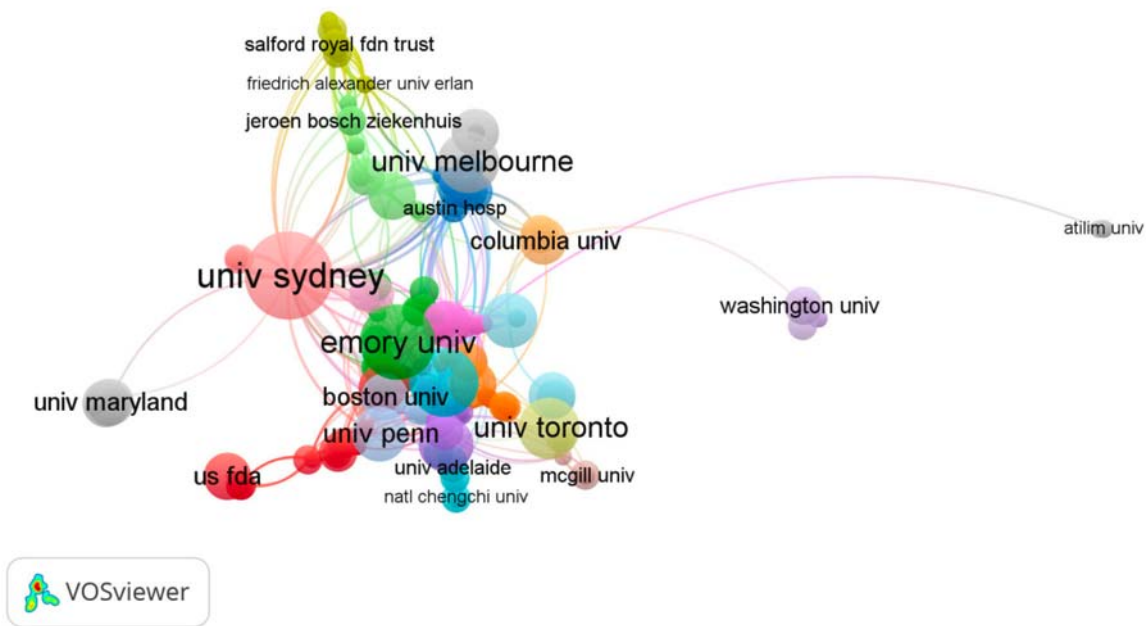


**Figure 1.** Countries that Produced the Most on the Subject. The size of the nodes represents the volume of publications in each country, the colors of the circle represent the publications of the country in a corresponding year. The color surrounding the circle indicates the extent to which the articles of a country have been cited in recent years, indicating a research front.

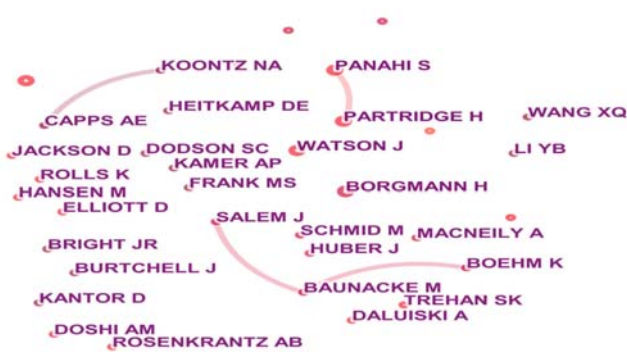
In this sense, it is evident that there is an influence of the United States of America, with 126 publications, on social media in healthcare as shown. Also this notable in Australia, with 31 publications; Canada, 28 publications; England 27 publications; and the Netherlands, with 16 publications. The figure 2 presents institutional production. Based on the result on figure 2, the major universities that deepen studies on social media and healthcare include: the University of Sydney, Sydney, with 10 publications, and the University of Melbourne, in the city of Melbourne, with 6 publications, both in Australia; University of British Columbia, with 7 publications, and the University of Toronto,

**Table 1.** Number of publications per year and type of documents.

Document Types/Publication Years	2009	2010	2011	2012	2013	2014	2015	2016	2017	2018	Totaling
Articles	0	0	0	3	3	15	38	50	51	53	213
Review	0	0	0	0	1	0	7	8	4	7	27
Editorial Material	0	0	0	0	2	1	2	1	6	7	19
Proceedings paper	0	0	0	0	0	0	1	3	3	1	8
Letter	0	0	0	0	0	0	1	0	1	0	2
Totaling	0	0	0	3	6	16	49	62	65	68	269



**Figure 2.** Institutions that Produced Most on the Subject. Items are represented by their label and, by default, also by a circle. The label size and circle of an item are determined by the weight of the item. The color of an item is determined by the cluster to which the item belongs. Lines between items represent links, that is, in this figure collaborations between universities. Univ Sidney – University of Sidney; Univ Melbourne – University of Melbourne ; Univ Penn – University of Pennsylvania; Emory Univ – Emory University; Univ Toronto – University of Toronto; Us Fda – US Food Drug Administration FDA; Columbia Univ – Columbia University; Boston Univ – Boston University; Univ Maryland – University of Maryland Baltimore; Univ Adelaide – University of Adelaide; Washington Univ – Washington University Wustl; Austin Hosp – Austin Hospital; Salford Royal Fdn Trust – Salford Royal NHS Foundation Trust; Jeroen Bosch Ziekanhuis; Nati Chengchi Univ – National Chengchi University; Mcgill Univ – Mcgill University; Friedrich Alexander University Erlan; Atilim Univ – Atilim University.



**Figure 3.** Networks of Co-authorship. SALEM J – Salem, Johannes; BAUNACKE M – Baunacke, Martin; BOEHM K – Boehm, Katharina; CAPPS AE – Capps, Alisha E.; KOONTZ NA – Koontz, Nicholas A.; PANAH S – Panahi, Sirous; HEITKAMP DE – Heitkamp, Darel E.; WANG XQ – Wang, Xuequn; JACKSON D – Jackson, Debra; DODSON SC – Dodson, Sean C.; KAMER AP – Kamer, Aaron P.; FRANK MS – Frank, Mark S.; BORGMANN H – Borgmann, Hendrich; HANSEN M – Hansen, Margareth; ELLIOTT D – Elliott Doug; SCHMID M – Schmid, Marianne; HUBER J – Huber, Johannes; MACNEILY A – MacNeily, Andrew; BRIGHT JR – Bright Jeremy R.; BURTCHELL J – Biurtchel Jeri; KANTOR D – Kantor, Daniel; TREHAN SK – Trehan, Samir K.; DOSHI AM – Doshi, Ankur M.;



**Figure 4.** Networks Cited References. The items are represented by their label and a circle. The size of the label and the circle of an item are determined by the weight of the item, the larger the circle, the more cited. The color of an item is determined by the cluster to which the item belongs. Lines between items represent links, that is, in this figure, collaborations between authors. Authors name: Von Muhlen (2012); Silver (2015); Usher (2014); Keller (2014); Brown (2014); Rolls (2016a); Salem (2016); Childs (2012); Patel (2017); Wadhwa (2018); Gilbert (2015); Abadi (2015)..

with 8 publications, were identified among Canada's most respected public institutions who engaged in the study on social media and healthcare services; Emory University located in Georgia, with 8 publications, and University of Pennsylvania, Pennsylvania, with 5 publications, and Columbia University, located in the city of New York, with 4 publications, both in United States, were equally active in this area of research as shown in figure 2. The next result presents network co-authorship.

Analyzing the references cited by the authors of the publications becomes essential to understand which authors were the theoretical bases for most of the papers that compose the sample.

Out of the authors sampled, Von Muhlen (2012) is the most cited work by authors of the research sample on the subject in question. It is worth highlighting that the Von Muhlen (2012) being most cited, followed by Silver (2015) and Usher (2014).

Based on the considerations made (see table 2 in the appendix), it is realized that there are still many challenges facing the use of social media in healthcare delivery, as some people rely fully on the information, while others take due precautions before using such information. On the other hand, others rejected the use of social media on ethical ground.

## Discussion

The relevance of social media, such as Facebook, Instagram, Twitter, among others for healthcare service delivery has been proven to be effective [6-8]. It is known that the validity of the information is important, therefore, the ethical and legal aspects must be taken into account. It is important to note that technological advances have contributed positively towards sharpening the relationships between doctors and patients through the dissemination of relevant and important information that is helpful to patients via the use of social media platform. It is noteworthy to note that the advancement of mobile technologies, in particular, the WhatsApp application and Facebook, favored the health workers (Doctors) in exchanging professionally educative information communication with patients and patient relatives. Currently, many government agencies and institutions such as Public Health Facilities, autonomous professional bodies are employing social media platforms in advertising both their services and sharing of information. In addition to the social media, in the health area there are mobile applications that are used to order, schedule, track, and manage health and wellness aspects [14]. However, in a very superficial manner, little is shared towards the contribution for the promotion of health [15].

Health professionals should employed empathy in dealing with the patients and patients' relations. They should respect individual persons with dignity while delivering health care service either online or otherwise to win the confidant of the patient; as such, the patients' may be reassured and be willing to share the most important personal information about his illness, which may, in turn, assist the health worker (doctor) to understand his condition better. In certain social contexts, especially when there is conflict, it becomes necessary to control one's own emotions as healthcare service provider and make an effort to understand and validate the feelings and perspective of the other person. In this sense, success in social and interpersonal relationships depends on the health workers' integration of empathic qualities - putting themselves in place of the other, assertive and problem-solving ability, with their cognitive and behavioral components [16], while discharging their duties. The search for training and new knowledge is essential for health professionals in order to develop their careers and improve themselves, and social media can offer a unique opportunity to interact and share knowledge [17]. In dealing with patients' information, health professionals may face sensitive situations. At the same time, health professionals are obliged with the privacy and confidentiality of the information, they are also committed to the truthfulness and fidelity of the facts, which may or may not imply disclosure [18]. It is also important to emphasize that the privacy policies of networks are not efficient, as they are easily circumvented by minors who wish to create an account in social networks, and there finding various content not suitable for their age group. Thus, there should be a concern of health professionals, in making any publication, always attentive to ethical rules and conduct aimed especially at adolescents and fragile, preventive in order not to cause harm to this public.

In order to minimize risks and maximize the benefits of using sources of health information as well as dealing with false information, a concerted effort is urgently needed. On the one hand, the specialization and training of professionals in this regard are paramount, so that they can validate the useful information and become less subject to possible manipulative attempts. There are ethical standards that should guide such procedure, these are: professionals should have compassion for the people involved; avoid creating false hopes and be rigorous in disseminating any information, which requires knowledge about science and medicine, including their methodologies relating to how to use medicine and use some medicinal tools [19].

Concerning the validity of information, it should be a constant. However, when forming online communities or WhatsApp groups, you must guard against free for all access and subject must be restricted to a specific goal

of community and group. It is essential to preserve the confidentiality and privacy of online users, as well as provide mechanisms for online users to express their concerns. In closed groups, the authorization of the administrator becomes fundamental before the data will be collected and analyzed [7]. What is published must be censored for validation; and checking the reliability of the information to be posted online for the consumption of the general users [15]. Another most significant aspect of online information is the consideration of the ethical issues, which must be guided by the policy provided for such regard. The relationships between users and professionals in social media occur in a harmonic way, herons to ethics [20]. Regulatory and ethical guidelines exist to ensure safety, integrity, consistency, confidentiality, and credibility of information. So that, the use of social media in the healthcare service delivery should be in accordance with ethical issues; and that only valid and verifiable information is made available for users so that they will benefit [8]. Online information needed to be validated and carefully authenticated, because it can reach a large number of population within a short time frame and once otherwise information was shared, its effect may be great and damaging [15]. For this reason, therefore, Healthy on the Net (HON) Foundation was founded. HON, an institution created for the regulation and certification of websites based information, whose content is aimed at the health segment in order to prevent and combat the proliferation of inconsistent and false information about health and health-related matters. This foundation has created a code of conduct - HONCode, which ensures that medical and health websites in general present objective, useful, and correct information from the point of view of specialists. Standards-compliant domains are certified and monitored regularly, which have the ability to detect technical irregularities [8].

## Conclusion

The results presented the countries, researchers and universities that produced the most on research on health and the use of social media, and demonstrated the efficiency of bibliometric and sociometry techniques for health research, going beyond a narrative review. It is concluded that social media is a competitive differential in the provision of health services. To this end, institutions should empower their employees, encourage them to seek and convey reliable and accurate information, monitor routines, and evaluate results through user feedback.

Technological advances bring innumerable benefits to companies that provide services, including health care, but to take advantage of them they cannot be averse to change. It is also worth emphasizing that health professionals should be cautious with publications made in social media, because there are laws that protect the identity, privacy, image, and privacy of the human being, and violation of these rights can have repercussions from a legal point of view [21]. There is a need to expand the focus of this study through case studies of success in the use of social media in the area of health. Current and future research in social media for healthcare can provide relevant information for researchers, students, physicians, health professionals, and other interested parties.

## Declarations

- **Ethics approval and consent to participate**  
Not Applicable
- **Consent for publication**  
Not Applicable
- **Availability of data and material**  
Not Applicable
- **Competing interests**  
All of the authors declare that they have no competing interests.
- **Funding**  
The authors didn't receive any funding. Sunil Shrestha<sup>1,2,3</sup>
- **Authors Contributions**  
SS, conceptualized the idea of this manuscript and wrote the initial version of the manuscript. JBF, added his ideas in the content of the initial version and did literature review and added the content of the manuscript and revised it substantially. AMG added his ideas and content of the initial version and helped substantially in improving manuscript through all stages of the manuscript writing. All authors read and approved the final manuscript.

## Conflict of Interest Statement

The authors have no conflict of interest to declare.



## References

1. ASHP statement on use of social media by pharmacy professionals: developed through the ASHP pharmacy student forum and the ASHP section of pharmacy informatics and technology and approved by the ASHP Board of Directors on April 13, 2012, and by the ASHP House of Delegates on June 10, 2012. *Am J Health Syst Pharm.* 2012;69(23):2095–7. <https://doi.org/10.2146/sp120011>
2. von Muhlen M, Ohno-Machado L. Reviewing social media use by clinicians. *J Am Med Inform Assoc.* 2012;19(5):777–81. <https://doi.org/10.1136/amiajnl-2012-000990>
3. Chauhan B, George R, Coffin J. Social media and you: what every physician needs to know. *J Med Pract Manage.* 2012;28(3):206–9.
4. Peck JL. Social media in nursing education: responsible integration for meaningful use. *J Nurs Educ.* 2014;53(3):164–9. <https://doi.org/10.3928/01484834-20140219-03>
5. Lambert KM, Barry P, Stokes G. Risk management and legal issues with the use of social media in the healthcare setting. *J Healthc Risk Manag.* 2012;31(4):41–7. <https://doi.org/10.1002/jhrm.20103>
6. Van de Belt TH, Engelen LJ, Berben SAA, Teerenstra S, Samsom M, Schoonhoven L. Internet and social media for health-related information and communication in health care: preferences of the Dutch general population. *J Med Internet Res.* 2013;15(10):e220. <https://doi.org/10.2196/jmir.2607>
7. Denecke K. Ethical aspects of using medical social media in healthcare applications. *Stud Health Technol Inform.* 2014;198:55–62. <https://doi.org/10.3233/978-1-61499-397-1-55>
8. de Camargo AL, Ito M. Use of Information technologies and communication in healthcare: use of social networks for doctors. *J Health Inform [Internet].* 2012[cited 2019 Jan 4];4(4):165–9. Available from: <http://www.jhi-sbis.saude.ws/ojs-jhi/index.php/jhi-sbis/article/view/220> Portuguese.
9. Cain J. Social media in health care: the case for organizational policy and employee education. *Am J Health Syst Pharm.* 2011;68(11):1036–40. <https://doi.org/10.2146/ajhp100589>
10. Smailhodzic E, Hooijsma W, Boonstra A, Langley DJ. Social media use in healthcare: A systematic review of effects on patients and on their relationship with healthcare professionals. *BMC Health Serv Research.* 2016;16:442. <https://doi.org/10.1186/s12913-016-1691-0>
11. Hawkins CM, Carlos RC. Exploring Social Media in Health Care: Beyond Its Pervasiveness. *J Am Coll Radiol.* 2018;15(1 Pt B):133–4. <https://doi.org/10.1016/j.jacr.2017.09.038>
12. Alshakhs F, Alanzi T. The evolving role of social media in health-care delivery: measuring the perception of health-care professionals in Eastern Saudi Arabia. *J Multidiscip Healthc.* 2018;11:473–9. <http://dx.doi.org/10.2147/JMDH.S171538>
13. Gagnon K, Sabus C. Professionalism in a digital age: opportunities and considerations for using social media in health care. *Phys Ther.* 2015;95(3):406–14. <https://doi.org/10.2522/ptj.20130227>
14. Housman LT. "I'm Home(screen)!: Social Media in Health Care Has Arrived. *Clin Ther.* 2017;39(11):2189–95. <https://doi.org/10.1016/j.clinthera.2017.10.007>
15. Almeida M, Stasiak D. The promotion of health in social media: An analysis of the profile of the Ministry of Health on Twitter [monograph on the Internet]. Universidade Federal de Goiás - UFG, Goiânia, GO; 2012[cited 2018 Nov 2];1–16. Available from: [https://especializacao.fic.ufg.br/up/294/o/A\\_promo%C3%A7%C3%A3o\\_da\\_sa%C3%BAde\\_nas\\_m%C3%ADdias\\_sociais\\_-\\_Mar%C3%ADlia\\_Almeida.pdf](https://especializacao.fic.ufg.br/up/294/o/A_promo%C3%A7%C3%A3o_da_sa%C3%BAde_nas_m%C3%ADdias_sociais_-_Mar%C3%ADlia_Almeida.pdf) Portuguese.
16. Carneiro RS, Falcone EMdO. A study of skills and disabilities in social skills in the elderly. *Psychol Study.* 2004;9(1):119–26. <http://dx.doi.org/10.1590/S1413-73722004000100015> Portuguese.
17. Hazzam J, Lahrech A. Health Care Professionals' Social Media Behavior and the Underlying Factors of Social Media Adoption and Use: Quantitative Study. *J Med Internet Res.* 2018;20(11):e12035. <https://doi.org/10.2196/12035>
18. Rosario MdS. The security of health information under DATA-SUS's responsibility: An Analysis with a focus on Privacy and Confidentiality [Internet]. Rio de Janeiro; 2010[cited 2018 Nov 2];1–99. Available from: <http://bases.bireme.br/cgi-bin/wxislind.exe/iah/online/?IsisScript=iah/iah.xis&src=google&base=LILACS&lang=p&nextAction=lnk&exprSearch=587475&indexSearch=ID> Portuguese.
19. Aroso I. The media as a source of health information: Risks and opportunities. *Rev Iberoamer Salud Ciudad [Internet].* 2012[cited 2018 Nov 2];1(2):84–110. Available from: [http://www.academia.edu/2495347/Os\\_Media\\_como\\_fonte\\_de\\_informa%C3%A7%C3%A3o\\_sobre\\_sa%C3%BAde\\_riscos\\_e\\_oportunidades](http://www.academia.edu/2495347/Os_Media_como_fonte_de_informa%C3%A7%C3%A3o_sobre_sa%C3%BAde_riscos_e_oportunidades) Portuguese.
20. Pacios M, de Campos CJR, Martha AS, Barra PSC. Medicine and health websites in face of Health on the Net Foundation-HON ethical principles. *Revista Bioética [Internet].* 2010[cited 2018 Nov 2];18(2):483–96. Available from: [http://revistabioetica.cfm.org.br/index.php/revista\\_bioetica/article/view/578](http://revistabioetica.cfm.org.br/index.php/revista_bioetica/article/view/578) Portuguese.
21. Martorell LB, Nascimento WFd, Garrafa V. Social networks, privacy, confidentiality and ethics: exposure of patient images on facebook. *Interface (Botucatu).* 2016;20(56):13–23. <http://dx.doi.org/10.1590/1807-57622014.0902> Portuguese.
22. Fuoco M, Leveridge MJ. Early adopters or laggards? Attitudes toward and use of social media among urologists. *BJU Int.* 2015;115(3):491–7. <https://doi.org/10.1111/bju.12855>



23. Glover M, Choy G, Boland GW, Saini S, Prabhakar AM. Radiology and social media: are private practice radiology groups more social than academic radiology departments? *J Am Coll Radiol*. 2015;12(5):513–8. <http://dx.doi.org/10.1016/j.jacr.2014.11.005>
24. Antheunis ML, Tates K, Nieboer TE. Patients' and health professionals' use of social media in health care: motives, barriers and expectations. *Patient Educ Couns*. 2013;92(3):426–31. <https://doi.org/10.1016/j.pec.2013.06.020>
25. Taylor HA, Kuwana E, Wilfond BS. Ethical Implications of Social Media in Health Care Research. *Am J Bioeth*. 2014;14(10):58–9. <https://doi.org/10.1080/15265161.2014.947820>
26. Saleh J, Robinson BS, Kugler NW, Illingworth KD, Patel P, Saleh KJ. Effect of social media in health care and orthopedic surgery. *Orthopedics*. 2012;35(4):294–7. <https://doi.org/10.3928/01477447-20120327-05>
27. Hawkins CM, Carlos RC. Exploring Social Media in Health Care: Beyond Its Pervasiveness. *J Am Coll Radiol*. 2018;15(1 Pt B):133–4. <https://doi.org/10.1016/j.jacr.2017.09.038>
28. Kotsenas AL, Arce M, Aase L, Timimi FK, Young C, Wald JT. The Strategic Imperative for the Use of Social Media in Health Care. *J Am Coll Radiol*. 2018;15(1 Pt B):155–61. <https://doi.org/10.1016/j.jacr.2017.09.027>
29. Smailhodzic E, Hooijsma W, Boonstra A, Langley DJ. Social media use in healthcare: A systematic review of effects on patients and on their relationship with healthcare professionals. *BMC Health Serv Res*. 2016;16:442. <https://doi.org/10.1186/s12913-016-1691-0>
30. Van de Belt TH, Engelen LJ, Berben SA, Teerenstra S, Samsom M, Schoonhoven L. Internet and social media for health-related information and communication in health care: preferences of the Dutch general population. *J Med Internet Res*. 2013;15(10):e220. <https://doi.org/10.2196/jmir.2607>
31. Atique S, Hosueh M, Fernandez-Luque L, Gabarron E, Wan M, Singh O, et al. Lessons learnt from a MOOC about social media for digital health literacy. *Conf Proc IEEE Eng Med Biol Soc*. 2016;2016:5636–9. <https://doi.org/10.1109/EMBC.2016.7592005>
32. Desai DG, Ndukwu JO, Mitchell JP. Social Media in Health Care: How Close Is Too Close? *Health Care Manag (Frederick)*. 2015;34(3):225–33. <https://doi.org/10.1097/HCM.0000000000000072>
33. Khudair AA, AIOshan MS. Caregivers of autistic children: Seeking information in social media. 2015 Intern Conf Inform Soc (i-Society) [Internet]. London (UK); 2015[cited 2018 Nov 18]:68–72. Available from: <https://ieeexplore.ieee.org/document/7366861>

## Appendix 1

**Table 2.** Current and Relevant Research on Social Media and Health Care (2009-2018).

S/N	Authors	Purpose	Methodology	Conclusion
1	Fatimah Alshakhs and Turki Alanzi [12]	To analyze the perception of health professionals in Saudi Arabia about the use of social media in health care.	Case study.	The results of this research indicate the relevance and usefulness of social media for physicians in order to publicize their services and disseminate health information. However, precautions must be taken concerning the privacy, and legal aspects, thus avoiding lawsuits that may tarnish the image of professional.
2	Michael Fuoco and Michael J. Leveridge [22]	Understand routines and procedures in the use of social media by urologists.	A case study at the Canadian Urology Association, using an online questionnaire for data collection.	It is concluded that the urologists are not using social media often. This inferred that they seldom used it to exchange ideas and information between colleagues.
3	Glover M, Choy G, Boland GW, Saini S, Prabhakar AM [23]	To evaluate the advantages of using social media by students and radiology professionals.	Case study.	It is concluded that radiology professionals are already adept at the use of specific social media, and the use of this tools seem to be valuable in increasing interaction between patients and the professionals.
4	Marjolijn L. Antheunis, Kiek Tates and Theodoor E. Nieboer [24]	To analyze the purposes, opportunities, and difficulties in the use of social media by patients and health professionals.	Field research work with patients and professionals of obstetrics and gynecologist, using interviews as an instrument.	The results demonstrated discordance in users' and professionals' motives about the use of social media in healthcare.
5	Holly A. Taylor, Ellen Kuwana and Benjamin S. Wilfond [25]	To describe the ways in which social media are used in health research, taking into account ethical aspects.	Conceptual review.	The review revealed a concerned over privacy, validity and reliability of information through social media. And concluded that to maintain the trust and credibility of online surveys, it must be ethical, valid, and reliable.
6	Jenine Saleh [26]	Analyze the strengths and weaknesses of the use of social media health focusing on the views of patients and physicians.	Conceptual review.	It is evident that social media can be used to disseminate knowledge, promote training. Use of social media encourages positive interaction between patients and professionals.
7	Jeff Cain [9]	Emphasize and discuss institutional policies and employee training on social media uses.	Conceptual review.	The review concludes that clear and accurate institutional policies on the use of social media and employee training can avoid ethical and legal disruption, avoiding complications.
8	Kerstin Denecke [7]	To promote awareness of ethical issues in the use of social media in the context of public health.	Conceptual review.	Based on the review, it became clear that the users are aware about ethical issues related to the use of social media in the field of public health.
9	Kendra Gagnon and Carla Sabus [13]	Demonstrate the emergence of social media in the health area, reporting the positives and negatives in its use by physiotherapists.	Conceptual review.	The paper concluded that it is essential to take into account legal, ethical and professional principles in the use of social media for health care services, but she they are of great relevance to provide mutual learning networks and useful platforms for the provision of reliable information by health professionals to users

S/N	Authors	Purpose	Methodology	Conclusion
10	C. Matthew Hawkins and Ruth C. Carlos [27]	Evaluate the ways in which social media impact the profession of physicians.	Conceptual review.	This work identified the impact of social media on the careers of physicians and the contemporary practice of medicine, its origin, and depth covering it uses, in the way that meetings, events, professional training are held, in the formation of online discussion groups.
11	Kotsenas AL, Arce M, Aase L, Timimi FK, Young C, Wald JT [28]	To analyze the strategic use of Social Media in Health Care.	Case study	It was verified that the researched institution used the social media as strategic differential, being important in the definition and expansion of the brand reach and in the increase of the demand for consultations.
12	Smailhodzic E, Hooijisma W, Boonstra A, Langley DJ [29]	To report the purpose of the use of social media by patients and health professionals and the relationships between them.	Conceptual review.	It is concluded that patients seek relationships and social support information in social media. They look for relationships and information that give technical, emotional and well-being support.
13	Van de Belt TH, Engelen LJ, Berben SA, Teerenstra S, Samsom M, Schoonhoven L [30]	To analyze the preferences of usage of the Internet and social media in healthcare.	Field research using interviews.	The paper concluded that a quarter of the population in the Netherlands would like to exchange information with their doctor through social media, with a probability of raising that percentage. And the authors suggested to health professionals the use of new forms of online communication and the facilitation of access by patients.
14	Atique S, Hosueh M, Fernandez-Luque L, Gabarron E, Wan M, Singh O, et al. [31]	Understand the obstacles faced by students in an online course related to health through social media and the quality of access and information.	Case study through an online survey.	The results concluded that there is a need for training of the general population (patients) on how to access and use social media in order to identify reliable and accurate information.
15	Desai DG, Ndukwo JO, Mitchell JP [32]	To explore the utilization of social media in the healthcare area.	A case study using data collection interviews with physicians in order to measure their perceptions about the relationship between physicians and patients via social media.	The results showed that most doctors do not hesitate to accept their patients as Facebook friends. This indicated that they are using Facebook to interact with their patients.
16	<i>Khudair, A. A. and AlOshan, M. S. [33]</i>	To analyse the usability of social media in healthcare service delivery considering the wellbeing of autistic patients.	Conceptual review.	The results showed that those responsible for autistic children are always researching additional information to authenticate prior information and ask if they are reliable and accurate, as well as emphasize the need to expand online information on autism.
16	<i>Khudair, A. A. and AlOshan, M. S. [33]</i>	To analyse the usability of social media in healthcare service delivery considering the wellbeing of autistic patients.	Conceptual review.	The results showed that those responsible for autistic children are always researching additional information to authenticate prior information and ask if they are reliable and accurate, as well as emphasize the need to expand online information on autism.

# THE IMPORTANCE OF TEACHING HISTORY OF PROSTHETIC DENTISTRY FOR FUTURE DENTISTS' PERSONALITY FORMATION

V. Galonsky<sup>1,2</sup>, V. Chernov<sup>1</sup>, R. Susloparova<sup>1</sup>, A. Gradoboev<sup>3</sup>

<sup>1</sup>Prof. V.F. Voino-Yasenetsky Krasnoyarsk State Medical University, Krasnoyarsk, Russian Federation

<sup>2</sup>Siberian Branch of the Russian Academy of Sciences Krasnoyarsk Scientific Center, Research Institute for Medical Problems of Northern Regions, Krasnoyarsk, Russian Federation

<sup>3</sup>Dental Clinic "Helios" LLC, Sharypovo, Russian Federation

## Abstract

Currently in the modern pedagogical process at a higher medical institution, teachers often shift emphasis towards the new technologies and methods for treating diseases. In this case, classical techniques, their development, and scientists who influenced the formation of orthopaedic dentistry are undeservedly downplayed in the training process. In order to preserve the interest of dental students in the historical process, it is necessary to teach the material taking into account modern processes that occur in orthopaedic dentistry. We searched for materials on the history of prosthetic dentistry in the scientific and historical literature. A special attention was paid to those moments of history that had been reflected in the present through modern materials, schools or methods of treating patients. After the selection of the materials and their discussion, the teaching staff of the KrasSMU Department-Clinic for Prosthetic Dentistry made proposals regarding each of the nine training cycles. In each study cycle, we included some information about historical moments and personalities that are known to be important for students' moral education and learning. Specifically, we used information taken from the scientific and historical literature, autobiographies, memoirs of contemporaries, and presentations containing material suitable for assimilation. Thus, we managed to naturally include the history of prosthetic dentistry into the educational process.

The applied approach to teaching the history of medicine had many positive aspects. Following up the development of views on various prosthetic dentistry issues allowed us to provide a more natural introduction to complex clinical disciplines. We emphasized the scientific experience continuity and the interdisciplinary approach to professional issues. A number of positive moral and ethical qualities were discussed that have allowed scientists to achieve significant results in their activities. Through the demonstration of domestic scientists' achievements, we carried out promotion of patriotism among the students. Considering the above advantages, we emphasize the importance of teaching the history of prosthetic dentistry in educating future dentists.

## Keywords

university pedagogy • prosthetic dentistry • Medical History • training modules

## Introduction

Over the past decades, dentistry as a branch of medicine has undergone significant changes in many areas [1, 2]. Advances in scientific and technological progress led to the emergence of many new materials, increase in their availability, and new high-tech equipment appeared. The number of research centres that study the fundamental and applied issues of medicine is increasing. In science, globalization begins which leads to the unhindered exchange of previously inaccessible experience between colleagues and the study of new problems. Scientists investigate previously underexplored nosological forms of diseases, and identify a lot of new ones. Recent development leads to the emergence of new dental schools, concepts, and techniques for the treatment of severe

patients [3]. Today, patients who previously could only get palliative care have new opportunities and solutions for a comfortable life and recovery.

Due to these changes prosthetic dentistry has a special status. The dentist has the final material result, namely finished orthopaedic structures. Advances in materials science and the study of dental diseases allow for more effective treatment of patients. Now there are opportunities for both aesthetic and functional rehabilitation. It is important to understand that such assistance has basically become available for the majority of the population [4, 5]. The availability of new technologies creates a high need for qualified specialists who can provide high-quality medical care.

Accordingly, a situation often arises at a medical university when the emphasis is shifted in favour of acquaintance with advanced treatment techniques and new concepts. Definitely, in order to prepare students as highly qualified specialists in dentistry, it is important to train them in modern technologies for treating patients. However, classical techniques and their modifications stagnate, and personalities, the value of their personal and professional growth, as well as the history of modifications are forgotten. Teachers pay very little attention to them. Certainly, this fact is directly reflected in the method of presentation, curriculum, and educational component of training [6].

Thus, there is a problem of effective integration of historical studies into the future doctors' training. It is important to preserve knowledge of the Medical History, and increase students' interest in it.

## Methods

To solve the problem of the applied nature of the Medical History in the dentists training, we studied the scientific and historical literature on the history of prosthetic dentistry, and found parallels between its modern achievements and classical techniques and their authors. We discussed the materials among the teaching staff of the KrasSMU Department-Clinic for Orthopaedic Dentistry with the aim of their introduction into training.

The presentation of historical material took place through the use of both historical literature and autobiographical essays, as well as through the use of digital learning technologies. During the presentation of the lecture material, historical background was provided for each topic studied. It contained a brief biography and the main achievements of the historical figures who influenced the development of prosthetic dentistry. We also considered the early versions of a particular structure, its development and independent branches. In the final slides, we provided important literary sources including classical textbooks. In practical classes, we showed prototypes and the development of various structures and materials that had been used previously.

An important factor in planning the presentation of the material was the applied nature of historical information in relation to current trends in prosthetic dentistry. For this purpose, we focused on certain important historical figures, namely, on their important achievements and moral qualities and their significance in the implementation of scientific activities.

## Results

At the KrasSMU Department-Clinic for Orthopaedic Dentistry, we consider the historical aspects of dental prosthetics when

studying modules. In total there are nine modules. They are as follows: "Materials Science in Prosthetic Dentistry" covered during the second semester, "Propaedeutics of Orthopaedic Dentistry" covered during the third and the fourth semesters, "Simple Dentures" covered during the fifth semester, "Complex Dental Prosthetics" and "Modern Technologies in Aesthetic Dentistry" - during the sixth semester, "Prosthetics in the Absence of Teeth" - during the seventh semester, "Gnathology and Functional Diagnosis of TMJ" - during the eighth semester, "Clinical Prosthetic Dentistry" - during the ninth and tenth semesters, and "Maxillofacial prosthetics" - during the tenth semester. We analyzed the historical literature and highlighted the main events and personalities that significantly influenced the development of Russian orthopaedic dentistry.

When studying the module "Materials Science in Orthopaedic Dentistry", students considered domestic people who made a significant contribution to the development and improvement of materials for orthopaedic manipulations and the manufacture of dental prostheses. Specifically, the developments by B. N. Bynin and other employees of the Central Institute for Traumatology, Orthopaedics and Prosthetics were discussed. The study of acrylic plastics made it possible to obtain the materials which are widely used for dentures today. V. N. Kopeikin and the employee of the Research Institute for Plastics V. N. Kotrelev developed the "Karbodent" plastic formulation which is widely used today in the orthopaedic structures. The works by S. S. Ass and D. N. Citrin made it possible to reduce the cost of prostheses through the development of stainless steel, which at the same time possessed a number of important qualities and did not adversely affect human health. Thus, in these examples, we focus on the independence of domestic production through the scientific achievements of our compatriots, which is especially important in modern realities. The close cooperation of dentists with research laboratories on the developments of fundamental character in materials science is very representative. An example of such cooperation is the collaboration of the MMSI Research Laboratory under the direction of V. Yu. Kurlyandsky with the Moscow Special Alloys Plant for the development of the first silver-palladium alloys used in orthopedic dentistry. This historical fact indicates the effectiveness and need in cooperative resolution of scientific and technical issues [7].

When studying the module "Propaedeutics of Orthopaedic Dentistry", first of all, students should know the functional anatomy of the masticatory apparatus and diagnostic activities in orthopaedic dentistry. Such domestic figures as N. I. Agapov and I. M. Oksman made a great contribution to the development of diagnostic measures. They proposed and implemented methods for non-invasive assessment of the chewing effectiveness loss. The activity of I. S. Rubinov and

S. E. Gelman is also important. They studied the loss of chewing efficacy with natural products, which is a very approximate method in relation to natural conditions. Although now, there are active developments in obtaining new methods for determining chewing effectiveness, these chewing samples do not lose their relevance due to natural test products and remain classic. The method of masticographic developed by I. S. Rubinov made it possible to identify in detail the important role of reflexes in contact with food in the mouth. Of particular importance is the "Functional Pathology" concept formulated by Professor V. Yu. Kurlyandsky [8]. According to I. V. Ushakov, this method of determining the orthopedic treatment plan is extremely successful and helps to avoid mistakes in the future. These works make it possible to more clearly understand the work of the chewing apparatus, the work of the digestive tract and the role of its relationship with the central nervous system, as well as evaluate the effectiveness of orthopedic treatment. An important point for the education of students is that all the above techniques, being classic, are relevant to this day. Both in our country and abroad, they are widely used in planning orthopaedic treatment and assessing the success of restoring the chewing function.

Extremely prominent historical figures are, no doubt, V. Yu. Kurlyandsky, V. N. Kopeikin, A. Ya. Katz, I. M. Oksman, B. N. Bynin, L. V. Ilina-Markosyan, E. M. Gofung, and others. We talk about them in the modules "Simple Dental Replacement" and "Complicated Dental Replacement". Their activity has radically changed the domestic orthopaedic dentistry, has formed many schools, which, in turn, have prepared many talented students. They carried out many significant studies for the clinician on important issues. These scientists have developed new methods of research, identified many forms of diseases, and developed measures to prevent these diseases. They suggested variations of orthopaedic structures for use in difficult clinical situations. These figures, no doubt, are an example of a scientist and a dentist, moral and inquisitive, striving for the development of his field, which is important in creating of the future dentist personal characteristics in training [9, 10].

The training module "Prosthetics in the Absence of Teeth" occupies a special place in the training future dentists. Knowledge about topographic-anatomical and functional features of the chewing and speech apparatus and their interaction with the orthopaedic structures, the study of clinical and laboratory stages - all this may be difficult to master. The aim is to facilitate the educational process by studying the historical development of views on the methods of complete removable dentures fixation. An important contribution was made by such personalities as V. Yu. Kurlyandsky, E. Ya. Vares, E. I. Gavrilov, and G. B. Brahman. The aim of their work was to improve the fixation of complete removable dentures, to obtain high-quality impressions and to study the possibilities

of structural materials. Of course, not all developments were successful. But a lot of groundwork can be found in modern methods, such as individual spoons, which G. B. Brahman previously proposed to make from wax. Before now, V. Yu. Kurlyandsky proposed to implant a metal frame in the lower jaw to improve the fixation of full dentures. Our scientists attempted to implant domestic developments, namely implants made of ACR-9 plastic or EHmass-12. This fact also indicates the need for disciplinary communication for the use of experimental techniques in the treatment of patients. Examination of failures in testing some manufacturing techniques and attempts to improve the fixation of prostheses allows the students to understand the mechanism of manufacturing a functionally effective full denture. The gradual finding of the optimal clinical and laboratory stages sequence through the interaction of various concepts and materials allows us to avoid mistakes, incomplete understanding of the methodology, and anatomical and physiological bases. And all this makes prosthetics functionally effective. Also, the formerly varied in success experience on this issue helps to outline development vectors in the future, without repeating previous mistakes and not entering into the previously experienced dead ends [11, 12].

At the Department-Clinic for Orthopaedic Dentistry of Krasnodar State Medical University, the module "Gnathology and Functional Diagnostics of the TMJ" is relatively young, but no less important. Understanding of the occlusal relationship and their anatomical and physiological rationale is important, both from a fundamental point of view and in the daily activities of a dentist. Domestic developments in this direction appeared to answer the clinical questions about treatment of complex nosological forms. A. Ya. Katz, A. M. Guzikov, and V. Yu. Kurlyandsky were actively engaged in studying the influence of articulation relationships, and their anatomical and functional substrate. A separate point is the study of views on TMJ diseases and their diagnosis, as views on the pathogenesis and etiology have undergone significant changes. B. N. Bynin and M. Z. Mirgazizov actively developed this subject. In the future, their students continued their fundamental work, and expanded the knowledge about the treatment of diseases associated with the disruption of the TMJ elements. Being one of the successful students, V. A. Khvatova developed and systematized many important issues of Russian Gnathology. Continuing the original goal of researching these diseases, scientists actively implement the gnathology fundamentals not only in the work of narrow specialists, but also in the everyday workflow of all dentists [13].

Clinical prosthetic dentistry, within the framework of the relevant module, is important in the professional activity of future dentists. This discipline is important in terms of both training and education. First of all, the subject teaches to use a comprehensive approach to the difficult clinical cases and



rehabilitation of patients. V. Yu. Kurlyandsky, E. I. Gavrilov, V. I. Kulazhenko, V. N. Kopeikin, and others made significant contributions. The activity of V. Kurlyandsky who solved a number of problems is especially important. He conducted many studies on the effect of denture materials on the human body, the classification of anatomical and morphological features of the maxillofacial area, and the issues of fixing removable dentures. Understanding the pathogenesis and etiology of periodontal disease has expanded significantly. His teaching activities led to the emergence of many talented students who continued to develop his ideas. Nowadays students of his students are working for the benefit of domestic dentistry and the health of patients. In general, the interdisciplinary approach of these scientists to solving complex clinical problems turned out to be very important. It allowed to form and order a set of the scientific and practical data received so far, to find effective solutions for treatment of patients, and to form domestic schools of dentistry.

The history of maxillofacial orthopaedics, which is studied in the training cycle "Maxillofacial Prosthetics" is considered from the earliest times. Many figures such as N. I. Pirogov, Y. Shimanovsky, S. Tigerstedt, and others developed various methods for rehabilitation of such patients in war and post-war time [14]. They offered techniques for fixing the jaws for fractures and gunshot wounds, which was especially important during the First and Second World Wars. They actively used affordable and cheap materials, such as rubber and aluminium wire. The availability, cheapness and ease of use of aluminium wire and its versatility allowed it to be widely used in various conditions. This fact is also very important for the search for new materials in the future for their widespread use. Modification history of obturator prosthetics is particularly significant due to their frequent practical application at this time. The pioneer was Ambraus Pare, who proposed replacing palate defects with a special structure - an obturator. Later on, many doctors made their improvements and developed methods for the rehabilitation of patients with various congenital and acquired dental-maxillary deformities. We note the contribution of such domestic scientists as I. M. Oksman, V. Yu. Kurlyandsky, Ya. M. Zbarzh, Z. Ya. Shur, E. Ya. Vares, and B. K. Kostur. Various scientists have proposed many ideas for the design of prostheses or their modifications. In this field, one can clearly see the continuity and development of several initial ideas through achievements and failures. It is important that both domestic and foreign doctors many times improved the original idea. It shows a long way of one development to the final result.

## Discussion

When studying each module, students learn about historical scholars who have made significant contributions to the

study of the topic being studied. However, simply analysing personalities and achievements may not reflect the importance and complexity of the work. Therefore, there is an emphasis on the context of those events that can have a beneficial effect on students as they contain positive goals [15]. To display the most beneficial ideas, it is important to carefully analyze the historical material to find interesting and accessible information for the presentation to students. Providing a complete set of historical facts may not cause the desired response of the trainees, as such a large and monotonous material is difficult to understand. Moreover, just such a narration can cause the student rejection to study the history of the specialty. The study of various historical personalities deserves special attention. The leading role here belongs to the life path, which the scientist passed in his professional activity. The complexities and peculiarities of life led to the formation of the necessary character traits due to which their professional success was achieved. Demonstration of intelligence, perseverance, persistence of character, sociability - all this can serve as an example for the moral image of the student as a future doctor. It is also important to demonstrate the continuity and education of the particular figure followers. Thanks to this, patience is instilled for labour. Many ideas and developments had come a long and thorny path through generations of researchers before they were used in the treatment. The patience with their colleagues is an example of educating the students and forming entire schools around concepts that academics had created. Illustrative are examples of dentists' cooperation with various scientific centres of other specialties. The success of this approach historically in the development of orthopaedic dentistry shows the need for cooperation in solving fundamental problems. Establishing links between different specialists is one of the most important skills in the profession of a dentist. Teaching considering the current state of prosthetic dentistry is an important pedagogical tool. First, it raises the necessary qualities of a future dentist. Secondly, it helps to understand that scientific and educational activity is a multi-component process. It requires a careful approach, and mistakes are inevitable. But errors make it possible to find other solutions and are also a starting point for new works. Thirdly, we show modernization and improvements of many tools habitual to us. In the future, young scientists reflect the comprehension of these moments in their works. Understanding the topic can be difficult without a vision of the background which stimulated the development of the scientific thought in this direction. Many achievements have become fundamental in modern orthopaedic dentistry. Many scientists worked in different areas and conducted parallel development. If specialization becomes the motto of work, it is an important educational moment in our time. It shows the importance of exploring different directions, regardless of specialization. Fourth, we must consider the importance of patriotic values cultivation

among the youth. In the context of globalization, the self-awareness within the framework of the fatherland undergoes significant changes. The trend displays all foreign, as the best with no alternative. This opinion is successfully replicated among young people. Thus, there is a need to foster patriotism as an alternative to the established trend. Demonstrating the achievements of domestic scientists who faced with the task of building independence from foreign materials and developing new methods with domestic materials is a good solution to this problem.

Given the above, we claim that teaching the history of orthopaedic dentistry, especially its domestic, Russian

branch, is necessary for the education of a full-fledged dentist. The combination of advantages with the applied nature of its presentation allows us to develop students' moral qualities. Successful examples of scientific activity foster patriotic feelings and improve the understanding of the basic material.

### Conflict of Interest Statement

The authors declare that there is no conflict of interest regarding the publication of this article.

### References

1. Pashkov KA. Main trends and tendencies historical development of our country dentistry. *Pract Med*. 2011;4(52):163–7. Russian.
2. De Paola DP. The evolution of dental education as a profession, 1936 – 2011, and the role of the Journal of Dental Education. *J Dent Educ*. 2012;76 (1):14–27.
3. Snakin VV, Ivanov OP, Vinnik MA. Globalization in the society, science and education. *Hist Pedagogy Nat Sci*. 2016;1:29–35. Russian.
4. Lapina NV, Izhnina EV, Grishechkin SD, Seferyan KG, Gr-ishechkin MS. Historical aspects of medical specialty “Dentistry”. *Kuban Sci Med Bull*. 2017;1(162):165–70. Russian. <https://doi.org/10.25207/1608-6228-2017-1-165-170>.
5. Crowley JP. The most important invention in the history of dentistry and what it teaches us about the future. *J Am Dent Assoc*. 2017;148:707–8. <https://doi.org/10.1016/j.adaj.2017.08.024>
6. Felker EV, Baroyan MA. Specificity of teaching the module “Dental Prosthesis (Basic Prosthesis)” in students of the dental faculty. *Mod High Technol*. 2018;4:184–8. Russian.
7. Lebedenko IYu, Anisimova SV. Contribution of Professor VYu. Kurlyandsky and his followers to the development of Russian dental materials science. *Cathedra. Dent Educ*. 2008;7(4):70–4. Russian.
8. Sperber GH. Teeth as pearls of wisdom. *BDJ*. 2017;223:787–8. <https://doi.org/10.1038/sj.bdj.2017.987>
9. Pilshchikova VV, Veselova DV, Vasiliev YuA. The role of medical history in forming the culture of medical students' personality. *Int J Appl Fundam Res*. 2017;4:211–2. Russian.
10. Tereshkina OV. The role of the History of Medicine in the solution of methodological problems pedagogy in medical institute. *J New Med Technol*. 2015; 22(1):116–21. Russian. <https://doi.org/10.12737/9091>
11. Lebedev VYu, Fedorov AV. Philosophy and history of science: the role of the history of medicine in contemporary university, social development and institutionalization of medicine. *Herald Tver State Univ. Series: Philos*. 2014;2:30–42. Russian.
12. Marchukova SM. History of Medicine in Nowadays' Education. *Stud Hist Biol*. 2011;3(1):76–89. Russian.
13. Sorokina TS. The teaching national medical history in the context of the world history. *Bull Peoples' Friendship Univ Russ. Series: Med*. 2000;2:104–5. Russian.
14. Maier K, Karenberg A. Dental care in modern art (1914–2014). *BDJ*. 2017;223:889–94. <https://doi.org/10.1038/sj.bdj.2017.998>
15. Shok NP, Sergeeva MS. The history of medicine as an academic discipline: traditions in clinical medical education and modern teaching methods. *Hist Med*. 2016;3(1):46–65. Russian. <https://doi.org/10.17720/2409-5583.t3.1.2016.05p>

# SIMULTANEOUS EVALUATION OF COMMUNICATION SKILLS BY STANDARDIZED PATIENTS AND MEDICAL EVALUATORS

Miguel A. Fernández-Villacañas<sup>1</sup>, Matilde Moreno-Cascales<sup>1</sup>, Sergio Alemán-Belando<sup>1,2</sup>, Manuel Matías-Sánchez<sup>1,3</sup>, Diego Flores-Funes<sup>1,2</sup>, Carmen Botella<sup>1,3</sup>, Joaquín García-Estañ<sup>1</sup>

<sup>1</sup>Centro de Estudios en Educación Médica, Facultad de Medicina, Universidad de Murcia

<sup>2</sup>Hospital Morales Meseguer

<sup>3</sup>Hospital Virgen de la Arrixaca, Murcia (Spain)

## Abstract

**Introduction:** The present study analyzes the evaluation of communication skills by standardized patients (SPs) and medical evaluators (Es) in an OSCE setting.

**Methods:** The OSCE involved 189 sixth-year medical students, as well as 34 SPs and 63 Es. Communications skills were evaluated in 8 stations, simultaneously by SPs and Es. The SPs were actors who had been trained in the clinical case and who acted in accordance with a standardized script in a simulated clinical situation. The evaluators, also standardized, were Resident Doctors or staff Doctors from the Hospital Services involved.

**Results:** The global scores awarded to students for communication skills were very similar in both groups, although the score awarded by Es was significantly higher, and a direct relationship was also observed between the mean scores awarded by both groups. Evaluators awarded significantly higher scores than SPs in 7 out of the 10 items on the checklist. Female medical students also scored significantly higher than their male counterparts in many items, including external appearance, listening, cordiality, optimism, interest, expression and empathy.

**Discussion:** Our data indicate that SPs and Es evaluated communication skills in a similar manner in an OSCE setting, a finding which suggests that health-related professionals can be used as an alternative to SPs, thus helping to lower economic costs. Our study also confirms a gender difference (in favor of women) in the evaluation of communications skills by both groups.

## Keywords

communication skills • standardized patients • gender • checklist • competence assessment • OSCE

## Introduction

Objective Structured Clinical Examination (OSCE) is a form of performance-based testing used to measure clinical competence, mostly among health science students [1-4]. Communication skills are one of the most important competences evaluated in an OSCE, since they are essential for the proper preparation of the clinical history and physical examination, as well as helping to ensure humane treatment and the best quality care (5). In addition to patient care, however, communication skills are also essential for teamwork and relationships with other colleagues and professionals, all of which should result in improved healthcare [6, 7].

This type of evaluation has traditionally been carried out by non-health professionals, generally people recruited as actors who represent a clinical case or scenario mimicking a real patient [8, 9]. It seems logical, therefore, that they be the ones required to evaluate the behavior of the person treating

them. The correct way to perform this task is through patient standardization, a process in which all simulated patients are trained to faithfully represent their clinical case, as well as to evaluate clinical communication competence in a fair and objective manner [10]. People thus trained are known as standardized patients (SPs). In this case, SPs are trained to evaluate students' skills based on a checklist of items for each station. They play through the interaction with the student, and then score them on the basis of their observations [11-13].

The advantages and disadvantages of SPs have been reviewed elsewhere, but there is general agreement regarding the fact that they reduce inter-rater variability in scoring students' performance [14]. However, one major issue is that using people outside the institution is expensive and greatly increases the overall cost of the OSCE. Our aim with this study was therefore to determine whether or not any differences

could be observed between the evaluation of communication skills by a standardized patient (SP) or by a medical evaluator (E). The literature in this area of medical education is limited and conflicting. Some studies have suggested that SP examiners are at least as reliable and “accurate” as physician examiners in evaluating student performance, while others have found SP raters to be inferior [14-16]. Our second aim was to assess the possible existence of gender differences in the communication skills evaluation process, an issue which has already been explored in some depth [14, 15].

## Methods

The OSCE test was conducted at the University of Murcia School of Medicine in June 2016, with 189 sixth-year undergraduate medical students. It consisted of a circuit of 20 stations with a time of 8 minutes per station and 2 minutes rest time between stations. The test was completed in 3 simultaneous runs, each comprising 20 students, with a total of 5 turns. Following the recommendations of the Spanish National Association of Deans of Medicine (CNDFME) [17], the clinical competence areas evaluated during the test were: 1) anamnesis (history taking), 2) physical examination, 3) technical skills and procedures, 4) communication skills, 5) clinical judgment, diagnostic and therapeutic management, 6) prevention and promotion of health, 7) interprofessional relations and 8) ethical-legal aspects and professionalism. The stations consisted of standardized patients, mannequin/procedures, a structured oral examination (with or without mannequin) and clinical reports. The present study was conducted exclusively at the 8 stations in which competence # 4 (communication skills) was evaluated, namely Cardiology, Hematology, Internal Medicine, Legal Medicine, Neurology, Oncology, Otorhinolaryngology and Family Medicine. These stations used standardized patients (SPs), i.e. non-medical actors who had been trained in the clinical case and who acted in accordance with a standardized script in a simulated clinical situation. Actors were recruited from the local actors’ association. An evaluator (E) was also present at each of the 8 stations to assess the corresponding medical components. These Es were Resident (in specialization training) Doctors or staff Doctors from the Hospital Services involved. Both SPs and Es were previously standardized in sessions specially designed for this purpose. First, they attended several [2, 3] 1-2 hour sessions in order to learn about the clinical case and standardize their role or evaluation, respectively. These sessions were led by the professor responsible for the case design. Next, another session was run by the OSCE coordinators to perform the standardization. During this session, a total of 14 simulated students, all of them first-year residents, were used as OSCE students.

Finally, on the day of the OSCE, communication skills were evaluated simultaneously by both the SPs and the Es, once the students had left the station, with all participants having 2 minutes to complete the checklist (Table 1). Both SPs and Es were instructed to score independently. The checklist used was a Likert-type rubric comprising 10 items, and is the one employed by all Schools of Medicine in Spain, as proposed by the CNDFME in 2012 [17]. It was developed on the basis of the previous version used and validated in our country [18]. Each item was scored on a 5-point scale with levels ranging from “very poor”, “poor”, “average”, “good” and “excellent”. The encounters were neither audiotaped nor videotaped. SPs (but not Es) received a €50 honorarium per run. A total of 34 SPs and 63 Es were used.

## Statistics

Since the Kolmogorov-Smirnov test revealed a normal distribution of the sample data, a t-Student test was performed to compare the means (both total and separate) in each of the 10 items evaluated. The unpaired t test was used to evaluate gender differences. A difference between groups was considered significant at a level of  $P < 0.05$ .

## Results

The test involved 189 sixth-year undergraduate medical students, with a mean age of 23 years and a range of between 22 and 28. The majority were women (109, 57.7%; 80 men, 42.3%). Figure 1 shows a representation of the global scores obtained by the students in each of the analyzed competences. The mean overall score obtained by students (with the SP evaluation value) was 73.23 points + 4.62 (women: 73.73 + 4.80 and men: 72.53 + 4.20), out of a possible maximum of 100. In the case of communication skills, which obtained the highest value of all in both SP and E evaluations, the global scores were very similar in both groups, although the E evaluation score was significantly higher (Table 2). These differences between SP and E evaluation scores were also observed for both men and women in the items Respect and Contact. However, women were evaluated significantly higher for the items Optimism, Interest and Empathy, whereas men scored higher for Listening and Contact (Table 2). A direct relationship was also observed between the scores awarded by SPs and Es (Figure 2). The correlation coefficient was 0.81. As regards gender, women consistently scored higher than men, with the difference being significant in 11 (out of 20) of these comparisons, including external appearance, listening, cordiality, optimism, interest, expression and empathy.

## Discussion

The primary aim of the present study was to analyze the results of the communication skills evaluation performed by SPs and Es during an OSCE of medical students. Despite some interesting differences which will be discussed below, the results reveal a very good general correlation between the evaluations conducted by the two groups (SP and E), thus suggesting that they could be carried out indistinctly. Although there is a significant overall difference between them, this may be due to the large sample size (almost 190 medical students). Thus, differences between 41.9 and 42.5 points (Table 2) have very little educational meaning. Similar data have also been reported by other studies [15, 19-23], although most of these analyzed the role of SPs as evaluators of clinical matters.

Although it has been suggested that lay examiners tend to be more lenient than physicians [20, 23, 24], in our data, most Es awarded higher scores than SPs in all communication skills items but one (external appearance). This finding is partially consistent with that reported previously in another study [25]. It is possible that some of the Es may have known the students previously, having been their teachers in class or their tutors in the hospital. Thus, a tendency towards awarding higher scores to future colleagues cannot be ruled out. Also, the situation of SPs, who act as patients, may be more demanding, thus prompting them to evaluate more harshly and demand better treatment, as indeed any real patient would do. These differences may also be dependent on the skills being rated, since it has been shown that while SPs perform better for communication skills [16], the judgments involved in assessing physical exam skills, history taking or clinical management may be more difficult for them to make, even with training. Such considerations should be taken into account, along with availability and cost trade-offs, when deciding which types of SPs or raters are effective for which kinds of stations/skills.

Significantly different responses were observed in some of the individual items on the checklist in accordance with student gender. Thus, women were evaluated significantly better for the items Optimism, Interest and Empathy, whereas men were evaluated better for Listening and Contact. A similar result was obtained by Graf et al. [25] who reported a significant gender difference in favor of female students in the empathy dimension, along with more positive statements.

In conclusion, SPs and Es evaluated communication skills similarly in an OSCE setting, suggesting that health-related professionals can be used as an alternative to SPs, thus helping to lower economic costs. Our study also found a gender difference, in favor of women, in the evaluation of communications skills by both groups, thus suggesting that women demonstrate superior skills to men, which confirms recent studies [25].

## Conclusion

Communication skills were very similarly evaluated by standardized patients and medical evaluators, although the score awarded by Es was significantly higher, and a direct relationship was also observed between the mean scores awarded by both groups. Female medical students scored significantly higher than their male counterparts in many communication skills items, including external appearance, listening, cordiality, optimism, interest, expression and empathy. Our finding suggests that health-related professionals can be used as an alternative to standardized patients, thus helping to lower economic costs of an OSCE. Our study also confirms a gender bias (in favor of women) in the evaluation of communications skills.

## List of abbreviations

OSCE: Objective structured clinical examination

SPs: standardized patients

Es: evaluators

CNDFME: Spanish National Association of Deans of Medicine

## Declarations

- Ethics approval: The study was not assessed by the University' Ethics Committee, since it was a mandatory evaluation of the Degree in Medicine.
- Consent for publication: All participants verbally agreed to participate in the OSCE test and approved the publication of results of the test.
- Availability of data and material: the dataset is available from the corresponding author on reasonable request.
- Competing interests: The authors have no declarations of interest to report.
- Funding: none
- Authors' contributions: All authors participated in the study concept and experimental design. MAFV, MMC, CB and JGE performed standardization of SPs and Es. SAB, MMS and DFF were responsible for the evaluated stations, collection of forms and spreadsheet coding. MMS and JGE performed the statistical analysis. MMS, CB and JGE drafted the manuscript. All authors read and approved the final manuscript.
- Acknowledgments: we are grateful for all the actors, professors and students who participated in the OSCE.



## References

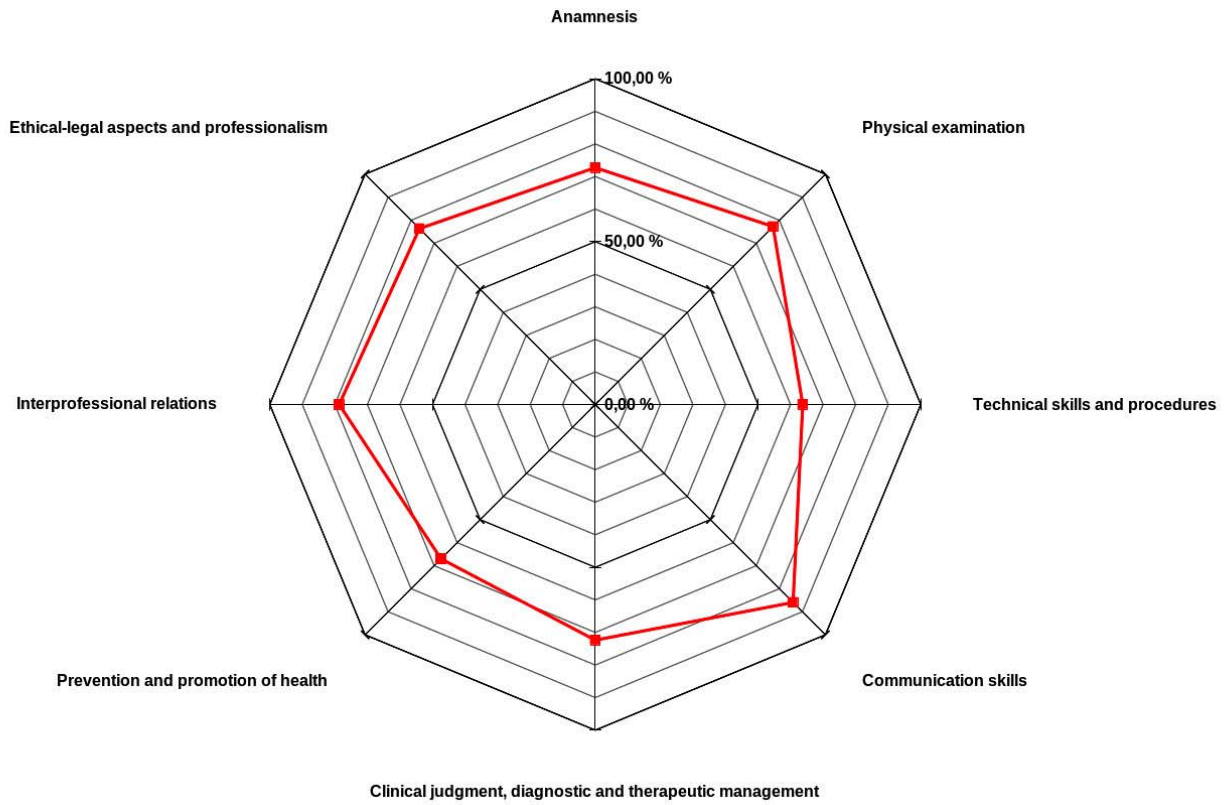
1. Harden RM, Stevenson M, Downie WW, Wilson GM. Assessment of Clinical Competence using Objective Structured Examination. *Br Med J*. 1975;1(5955): 447–51. <https://doi.org/10.1136/bmj.1.5955.447>
2. Khan KZ, Ramachandran S, Gaunt K, Pushkar P. The Objective Structured Clinical Examination (OSCE): AMEE Guide No. 81. Part I: an historical and theoretical perspective. *Med Teach*. 2013;35(9):e1437–46. <https://doi.org/10.3109/0142159X.2013.818634>
3. Khan KZ, Gaunt K, Ramachandran S, Pushkar P. The Objective Structured Clinical Examination (OSCE): AMEE Guide No. 81. Part II: Organisation & Administration. *Med Teach*. 2013;35(9):e1447–63. <https://doi.org/10.3109/0142159X.2013.818635>
4. Boursicot K, Roberts T. How to set up an OSCE. *Clin Teach*. 2005; 2(1):16–20. <https://doi.org/10.1111/j.1743-498X.2005.00053.x>
5. Schirmer JM, Mauksch L, Lang F, Marvel MK, Zoppi K, Epstein RM, Brock D, Pryzbylski M. Assessing communication competence: a review of current tools. *Fam Med*. 2005;37(3):184–92.
6. Kaplonyi J, Bowles KA, Nestel D, Kiegaldie D, Maloney S, Haines T, et al. Understanding the impact of simulated patients on health care learners' communication skills: a systematic review. *Med Educ*. 2017;51(12):1209–19. <https://doi.org/10.1111/medu.13387>
7. Babiker A, El Hussein M, Al Nemri A, Al Frayh A, Al Juryyan N, Faki MO, et al. Health care professional development: Working as a team to improve patient care. *Sudan J Paediatr*. 2014;14(2):9–16.
8. Laidlaw A, Hart J. Communication skills: an essential component of medical curricula. Part I: Assessment of clinical communication: AMEE Guide No. 51. *Med Teach*. 2011;33(1):6–8. <https://doi.org/10.3109/0142159X.2011.531170>
9. Radziej K, Loechner J, Engerer C, Niglio de Figueiredo M, Freund J, Sattel H, et al. How to assess communication skills? Development of the rating scale ComOn Check. *Med Educ Online*. 2017;22(1):1392823. <https://doi.org/10.1080/10872981.2017.1392823>
10. Hardee JT, Kasper IK. From Standardized Patient to Care Actor: Evolution of a Teaching Methodology. *Perm J*. 2005;9(3):79–82.
11. Barrows HS. An overview of the uses of standardized patients for teaching and evaluating clinical skills. *Acad Med*. 1993;68(6):443–51.
12. Chong L, Taylor S, Haywood M, Adelstein BA, Shulruf B. Examiner seniority and experience are associated with bias when scoring communication, but not examination, skills in objective structured clinical examinations in Australia. *J Educ Eval Health Prof*. 2018;15:17. <https://doi.org/10.3352/jeehp.2018.15.17>
13. Schleicher I, Leitner K, Juenger J, Moeltner A, Ruesseler M, Bender B, et al. Examiner effect on the objective structured clinical exam: a study at five medical schools. *BMC Med Educ*. 2017;17(1):71. <https://doi.org/10.1186/s12909-017-0908-1>
14. Setyonugroho W, Kennedy KM, Kropmans TJ. Reliability and validity of OSCE checklists used to assess the communication skills of undergraduate medical students: A systematic review. *Patient Educ Couns*. 2015;98:1482–91. <https://doi.org/10.1016/j.pec.2015.06.004>
15. Graf J, Smolka R, Simoes E, Zipfel S, Junne F, Holderried F, et al. Communication skills of medical students during the OSCE: Gender-specific differences in a longitudinal trend study. *BMC Med Educ*. 2017;17(1):75. <https://doi.org/10.1186/s12909-017-0913-4>
16. Swanson DB, van der Vleuten CP. Assessment of Clinical Skills With Standardized Patients: State of the Art Revisited. *Teach Learn Med*. 2013; 25(S1):S17–25. <https://doi.org/10.1080/10401334.2013.842916>
17. García-Estañ J. Prueba Nacional de Evaluación de Competencias Clínicas de la Conferencia Nacional de Decanos de Facultades de Medicina de España. *FEM*. 2013;16(3):S59–62.
18. Kronfly RE, Ricarte Diez JI, Juncosa FS, Martínez Carretero JM. Evaluation of the clinical competence of Catalan medicine schools 1994-2006. Evolution of examination formats until the objective and structured clinical evaluation (ECO). *Med Clin*. 2007;129(20):777–84.
19. Makkuchi A, Takemoto Y, Fukumoto K, Tochino Y, Morimura M, Shuto T. Concurrence and differences between Faculty staff and Standardized patients in the assessment of Medical Students in the postclinical clerkship objective structured clinical examination [Internet]. AMEE: Abstract Book of annual conference (Congress center, Basel, Switzerland, 25-29 August 2018). Basel; 2018[cited 2019 Mar 28]:89. Available from: <https://amee.org/getattachment/Conferences/AMEE-2018/Abstracts/AMEE-2018-Abstract-Book.pdf>
20. Heine N, Garman K, Wallace P, Bartos R, Richards A. An analysis of standardised patient checklist errors and their effect on student scores. *Med Educ*. 2003;37(2):99–104.
21. Han JJ, Kreiter CD, Park H, Ferguson KJ. An experimental comparison of rater performance on an SP-based clinical skills exam. *Teach Learn Med*. 2006;18(4): 304–9. [https://doi.org/10.1207/s15328015tlm1804\\_5](https://doi.org/10.1207/s15328015tlm1804_5)
22. McLaughlin K, Gregor L, Jones A, Coderre S. Can standardized patients replace physicians as OSCE examiners? *BMC Med Educ*. 2006;6:12. <https://doi.org/10.1186/1472-6920-6-12>
23. Park J, Ko J, Kim S, Yoo H. Faculty observer and standardized patient accuracy in recording examinees' behaviors using checklists in the clinical performance examination. *Korean J Med Educ*. 2009;2(3):287–97. <https://doi.org/10.3946/kjme.2009.21.3.287>



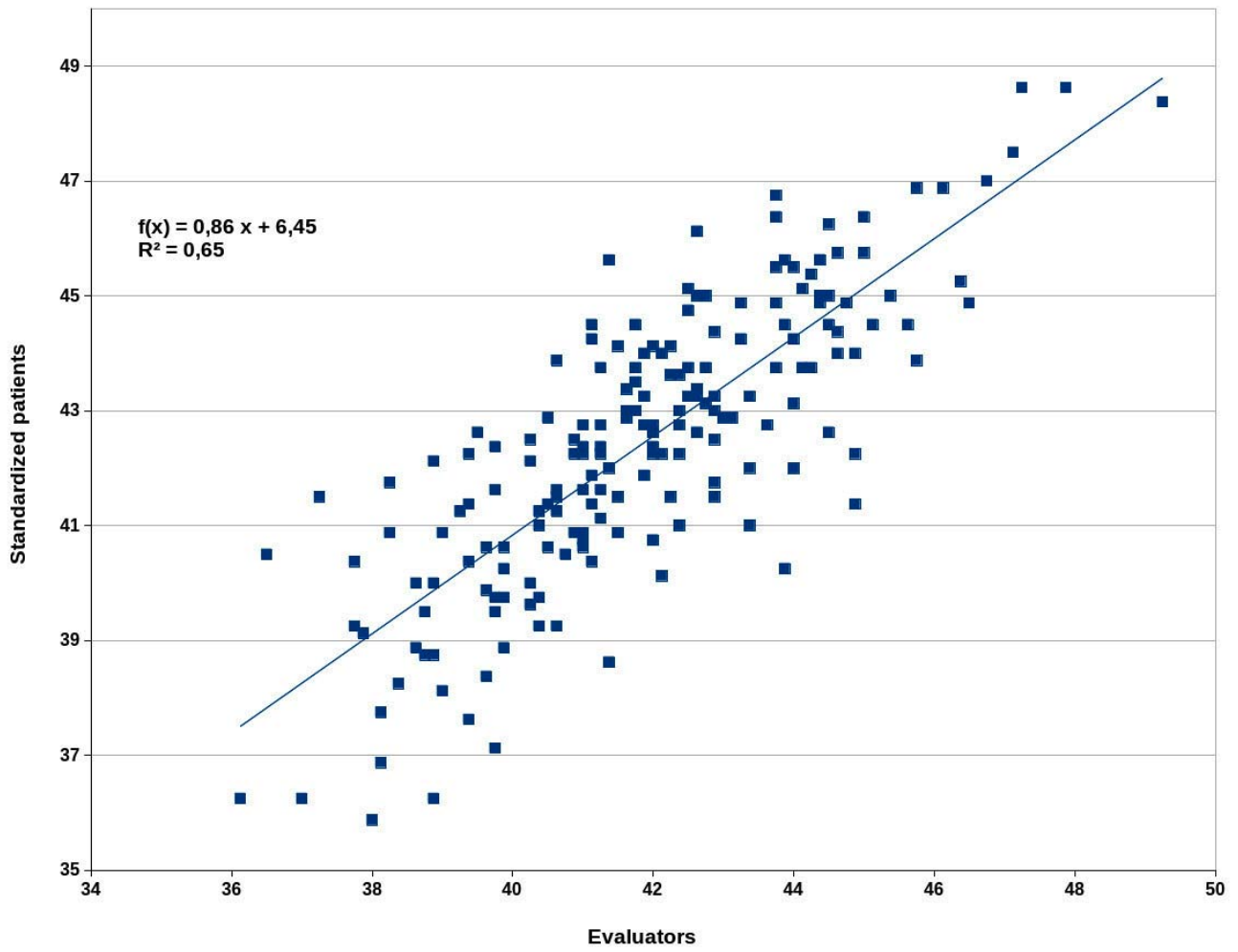
24. Zanetti M, Keller L, Mazor K, Carlin M, Alper E, Hatem D, et al. Using standardized patients to assess professionalism: A generalizability study. *Teach Learn Med.* 2010; 22(4):274–9. <https://doi.org/10.1080/10401334.2010.512542>
25. Regehr G, Freeman R, Robb A, Missiha N, Heisey R. OSCE performance evaluations made by standardized patients: Comparing checklist and global rating scores. *Acad Med.* 1999;74(10 Suppl): S135–7.

**FIGURE LEGENDS**

**Figure 1.** Global results of the OSCE, organized by competences.



**Figure 2.** Dispersion diagram reflecting the relationship between the communications skills' evaluations of standardized patients and evaluators.



**Table captions****Table 1.** Communication checklist

---

**External appearance:** Careful appearance, good hygiene, correct body posture

**Listening:** Listens properly, does not interrupt, is attentive, watches while talking

**Cordiality:** Make pleasant first contact, smiles

**Respect:** At no time criticizes or makes pejorative judgments

**Tranquility:** Stays calm, emotionally controlled

**Optimism:** Sees the positive aspects of situations, tries to encourage the patient

**Contact:** Any physical contact during physical examination or greeting is careful and kind

**Interest:** Is interested in opinions, beliefs, values, concerns and emotions

**Expression:** Expresses themselves clearly at all times

**Empathy:** When faced with intense patient emotions (pain, anxiety, joy), participates and sympathizes or tries to understand them in order to help the patient cope with them

---

**Table 2.** Absolute values awarded in the assessment of communication by standardized patients (SP) and evaluators (E). \*, p<0.05 between SP and E; +, p<0.05 between Women and Men

		GLOBAL (%)	WOMEN (%)	MEN (%)
<b>Total score</b>	SP	41.9 ± 2.31	42.29 ± 2.12+	41.36 ± 2.47
	E	42.47 ± 2.45 *	42.85 ± 2.35 *+	41.94 ± 2.51*
<b>External appearance</b>	SP	4.66 ± 0.21	4.69 ± 0.15 +	4.61 ± 0.26
	E	4.64 ± 0.27	4.69 ± 0.23 +	4.57 ± 0.31
<b>Listening</b>	SP	4.33 ± 0.30	4.39 ± 0.26 +	4.25 ± 0.34
	E	4.39 ± 0.25 *	4.42 ± 0.25	4.35 ± 0.25*
<b>Cordiality</b>	SP	4.39 ± 0.31	4.43 ± 0.30 +	4.33 ± 0.31
	E	4.40 ± 0.32	4.43 ± 0.31	4.36 ± 0.33
<b>Respect</b>	SP	4.48 ± 0.24	4.51 ± 0.25	4.45 ± 0.22
	E	4.64 ± 0.23 *	4.64 ± 0.22 *	4.61 ± 0.24*
<b>Tranquility</b>	SP	4.13 ± 0.38	4.17 ± 0.38	4.07 ± 0.38
	E	4.18 ± 0.34 *	4.20 ± 0.34	4.13 ± 0.35
<b>Optimism</b>	SP	3.90 ± 0.38	3.94 ± 0.36	3.85 ± 0.39
	E	3.96 ± 0.36 *	4.01 ± 0.33 *+	3.88 ± 0.39
<b>Contact</b>	SP	4.08 ± 0.40	4.12 ± 0.41	4.03 ± 0.38
	E	4.17 ± 0.40 *	4.21 ± 0.39 *	4.12 ± 0.42*
<b>Interest</b>	SP	3.83 ± 0.35	3.88 ± 0.33 +	3.76 ± 0.35
	E	3.90 ± 0.35 *	3.95 ± 0.34 *+	3.83 ± 0.34
<b>Expression</b>	SP	4.20 ± 0.31	4.24 ± 0.30 +	4.15 ± 0.31
	E	4.22 ± 0.35	4.24 ± 0.35	4.18 ± 0.33
<b>Empathy</b>	SP	3.89 ± 0.35	3.90 ± 0.33	3.85 ± 0.37
	E	3.97 ± 0.36*	4.03 ± 0.36*+	3.88 ± 0.34

# DEVELOPMENT OF ADDITIONAL PROFESSIONAL MEDICAL EDUCATION ORGANISATION IN ACCORDANCE WITH THE PRINCIPLES OF QUALITY MANAGEMENT

V. Shprakh<sup>1</sup>, S. Gorbacheva<sup>1</sup>, M. Golubchikova<sup>1,2</sup>

<sup>1</sup> Irkutsk State Medical Academy of Post-Graduate Education, Irkutsk, the Russian Federation

<sup>2</sup> Irkutsk State University, Irkutsk, the Russian Federation

## Abstract

Issues of education quality have acquired special relevance since the beginning of the 20th century. Implementation of the idea of quality in the educational organisation is promoted by use of the international ISO standards regulating quality of the management system. Certification of a quality management system in an organisation ensures its sustainable development. Experience of such work exemplified by additional medical education organisation is presented in the article.

The present paper addresses approaches to implementation of the following quality management principles: customer focus; leadership; involvement of people; process approach; continuous improvement; evidence-based decision making; relationship management; system approach to management. The structure of processes in the medical education institution is presented including the major process “Professional training and retraining in the field of health care”, main (core) processes: “Educational activities” and “Scientific activities”; management processes: “Strategic planning”, “Documentation management”, “Records management”, “Internal audits”, “Nonconformity management”, “Corrective and preventive actions”, “Monitoring and measurement of processes and educational services”, “Quality management system analysis by senior management”; supporting processes: “Personnel management”, “Work environment management and information support”, “Financial and economic support”, “Library services”, “Methodical support of the educational process and training for teachers”, “Publishing activities”. All processes are designated in a consistent model with special codes, which helps to streamline the document management system in the organisation.

## Keywords

educational organisation • additional education • medical education • quality management • principles of quality management • International ISO standards.

## Introduction

Objective Structured Clinical Examination (OSCE) is a form of performance-based testing used to measure clinical competence, mostly among health science students [1-4]. Communication skills are one of the most important competences evaluated in an OSCE, since they are essential for the proper preparation of the clinical history and physical examination, as well as helping to ensure humane treatment and the best quality care (5). In addition to patient care, however, communication skills are also essential for teamwork and relationships with other colleagues and professionals, all of which should result in improved healthcare [6, 7].

This type of evaluation has traditionally been carried out by non-health professionals, generally people recruited as

actors who represent a clinical case or scenario mimicking a real patient [8, 9]. It seems logical, therefore, that they be the ones required to evaluate the behavior of the person treating them. The correct way to perform this task is through patient standardization, a process in which all simulated patients are trained to faithfully represent their clinical case, as well as to evaluate clinical communication competence in a fair and objective manner [10]. People thus trained are known as standardized patients (SPs). In this case, SPs are trained to evaluate students' skills based on a checklist of items for each station. They play through the interaction with the student, and then score them on the basis of their observations [11-13].



The advantages and disadvantages of SPs have been reviewed elsewhere, but there is general agreement regarding the fact that they reduce inter-rater variability in scoring students' performance [14]. However, one major issue is that using people outside the institution is expensive and greatly increases the overall cost of the OSCE. Our aim with this study was therefore to determine whether or not any differences could be observed between the evaluation of communication skills by a standardized patient (SP) or by a medical evaluator (E). The literature in this area of medical education is limited and conflicting. Some studies have suggested that SP examiners are at least as reliable and "accurate" as physician examiners in evaluating student performance, while others have found SP raters to be inferior [14-16]. Our second aim was to assess the possible existence of gender differences in the communication skills evaluation process, an issue which has already been explored in some depth [14, 15].

## Methods

Development and deployment of a QMS in an educational organisation inevitably leads to development of the organisation if it is fully based on the principles of quality management [5]. These principles were formulated by Edwards Deming and reflected in the International ISO Standards 9001. In particular, the following principles of quality management are formulated in the latest version of the ISO 9001:2015 International Standard "A quality management system – Requirements":

- customer focus;
- leadership;
- involvement of people;
- process approach;
- continuous improvement;
- evidence-based decision making;
- relationship management
- system approach to management [6, 7].

The Irkutsk State Medical Academy for Post-Graduate Education (ISMAPE) has always acted in compliance with the majority of these principles. In the second half of the 20th century, intensification of industrial forces in Siberia and the Far East defined the need for further development of healthcare in these regions. Moreover, the progress of medical science required widespread introduction of scientific developments into medical practice by the end of the 1970th. All this was closely associated with the problem of training, retraining and professional development of doctors. The approach oriented toward customers, who were doctors, medical institutions, the society and the state, became a basis for work of the management and teachers of the Academy. The leadership of the Academy senior staff, their wise management alongside with

permanent involvement of a group of teachers and employees in solution of strategic questions facilitated effective work. The idea of cooperation could be clearly traced from the very beginning of work of the Academy. "The higher the cooperation level is, the better it is used by the society and organisations having natural and material resources, intellectual and spiritual potential of the human person at their disposal" [8].

The staff of the educational institution began to solve most important problems of training in the huge region. Currently, it is the Irkutsk State Medical Academy – a medical educational institution of professional development and professional retraining of healthcare experts in the Siberian Federal District, the Republics of Buryatia and Sakha (Yakutia), the coordination centre of postgraduate education of the Siberian Federal District, a scientific research centre for most important fields in clinical medicine and pharmaceuticals.

The Irkutsk State Medical Academy of Postgraduate Education comprises 37 departments of the faculties of General Medicine and Surgery. Over 7000 doctors, pharmacists and paramedics study at the Academy annually. It is impossible to construct an effective organisation based on copying known decisions, procedures and rules inherited from the glorious but already gone past, especially in a dynamically changing environment, in conditions of an indeterminable future.

Therefore, the evidence-based decision making principle brought the head of the Academy to development of a QMS. This process started in 2009, and in 2010, the Academy underwent certification of its QMS successfully. From this point, the academy work has been carried out according to the principles of the process approach and continuous improvements.

The purpose of QMS introduction is to create conditions for application of the system approach to the organisation management process. Interrelations and interaction have been established between processes; these are documented in the "Book of processes" and the "Quality manual" [9, 10].

The major process of the QMS is "Professional training and retraining in healthcare". This process consists of the following basic service lifecycle processes: EP-1 "Analysis of consumer requirements", EP-2. "Design and development of educational programmes", EP-3 "Students enrolment", EP-4 "Educational activity", EP-5 "Scientific activity", EP-6 "Analysis of consumers' satisfaction".

The main process EP-4 "Educational activities" consists of the following sub-processes: EP-4.1 "Advanced training and professional retraining", EP-4.2 "Training of clinical interns", EP-4.3 "Moral and extracurricular work with students", EP-4.4 "Assistance to employment of graduate students".

The main process EP-5 "Scientific activity" consists of the following sub-processes: EP-5.1 "Training of top-qualification personnel", EP-5.2 "Research and development". The main processes are accompanied by management and supporting processes.

Among the management processes there are MP-1 “Strategic planning”, MP-2 “Documentation management”, MP-3 “Records management”, MP-4 “Internal audits”, MP-5 “Nonconformity management”, MP-6 “Corrective and preventive actions”, MP-7 “Monitoring and measurement of processes and educational services”, MP-8 “Quality management system analysis by senior management”.

The support processes are SP-1 “Personnel management”, SP-2 “Work environment management and information support”, SP-3 “Financial and economic support”, SP-4 “Library services”, SP-5 “Methodical support of the educational process and training for teachers”, SP-6 “Publishing activities”.

Documentation of the Academy (regulations, instructions, document forms, lists, etc.) is maintained in compliance with the aforementioned processes and systematised in a two-volume local acts collection of the Academy.

The QMS of the Academy is in an actual condition which is confirmed by internal and external audits (2011, 2012, 2014, 2015) as well as by a successful recertification procedure in 2013.

## Results

During the development of a certified QMS, the following positive tendencies were noted:

- the Academy successfully underwent procedures of internship and postgraduate education accreditation;
- managers and employees claim that there was a visible streamlining in activities of the organisation. The “List of local acts, instructions and document forms of the Irkutsk SMAPE” directed at integration of electronic and paper documentation (in connection with development of the electronic document flow and the website of the Academy);
- the Academy development programme until 2020 and structural division quality plans decomposing purposes and development program tasks at lower management levels are being implemented including the “Indicators of educational activities of the department in 2014-2020” tables.
- by the results of internal audits, we can observe improvement of the following processes and activity types: “Documentation management”, “Communication with customers”, “Goals in the area of quality”, “Monitoring and measurement”, “Design and development of educational programmes”, “Educational activity”;
- initial (desires and expectations) and final (satisfaction) electronic questioning of the listeners is conducted.

Work of the Academy in the Russian Science Citation Index (RSCI) with the LLC “SCIENTIFIC ELECTRONIC LIBRARY E-library” is continued. As a result, the number of presented

works increased from 2000 in 2013 to 5836 in 2015 and the h-index increased from 10 to 28. The Academy lies in the 216th place among 883 High schools in Russia in terms of the total amount of works and also takes the second place among additional medical professional education organisations.

Analysis of final questioning showed high satisfaction by training quality in the ISMAPE and training conditions as well as educational and methodical materials. The widest coverage in questioning is noted at professional retraining cycles. According to the results of the cycles:

- 93.1 % of the listeners were satisfied with lectures;
- 91.8 % were satisfied with quality of a practical training;
- 88.9 % were satisfied with training conditions;
- 97.0 % marked positively quality and usefulness of the offered learning aids.

## Discussion

The QMS of the Irkutsk State Medical Academy of the Ministry of Health of the Russian Federation is a means for achievement of goals and maintaining of the policy in the field of quality; it gives confidence to the organisation and its customers in the institution’s capability:

- to carry out modernisation of educational activities provided by the Academy for ensuring continuous process of training, retraining and advanced training of personnel for the healthcare system through extension of the list of educational programmes and increase in the amount of educational services;
- to increase research activity efficiency of the Academy by integration of medical science, practical healthcare and additional professional education, improvement of training quality for national specialists and introduction of a scientometric assessment system;
- to introduce innovative transformations in all main activities of the Academy through application of information, simulation, remote, organisational and other modern technologies;
- to provide for medical development and preventive activities stability in the Academy via expansion of the range and amount of high-quality medical services;
- to create conditions for the health worker’s image promotion on the basis of spiritual, moral, cultural and educational and sporting activities at the Academy, expansion of partnership and long-term cooperation;
- to increase economic stability through establishment of an effective marketing policy, increase in the amount of revenue-producing activities and formation of new education markets;

- to expand the Academy's international activity by participation in foreign projects, training and scientific actions, to promote academic mobility of its employees and students, to increase the international prestige of the Academy.

Therefore, development, implementation, certification and maintenance of a QMS in an organisation, to our mind, ensure its sustainable development to promote the organisation lifecycle processes quality and, subsequently, the quality of educational services.

Further development of the educational organisation suggests an active use in activity of all structures the management quality principles. The special emphasis

should be put on the principle of management relationships. Moreover, these processes will be maintained in case if the Academy status changes and it is converted into the branch of the Russian State Medical Academy for Post-Graduate Education.

Currently, the Academy accomplishes its goals and objectives as a branch of the Russian Medical Academy of Continuous Professional Education.

### Conflict of Interest Statement

Authors have no conflicts of interest to declare.

### References

1. Levshina VV. University quality system. M.: INFRA-M; 2016. 280 p. Russian.
2. Conference communique of high education ministers [Internet]. Berlin, 2003 Sept 19 [cited 2018 Apr 15]. Russian. Available from: <http://www.russia.edu.ru/information/legal/law/inter/berlin/>
3. Azar'eva VV, Kruglov VI, Puzankov DV, Sobolev VS, Solov'ev VP, Stepanov IV, et al. Methodical recommendations of standard model introduction of the quality system in educational institution [Internet]. Sankt-Peterburg: SPbGEHTU «LEHTI»; 2006 [cited 2018 Apr 15]. 408 p. Russian. Available from: [http://sko.osu.ru/docs/rekomend\\_po\\_vnedr.pdf](http://sko.osu.ru/docs/rekomend_po_vnedr.pdf)
4. Gerasimova MM., Evseeva SA, Levshina VV. Innovative approach to improving the quality of services provided in the health system [Internet]. REJ-online. 2017[cited 2018 Apr 15];3:7. Russian. Available from: <http://www.e-rej.ru/upload/iblock/498/4982532a273443de2eae3b031bca2ca7.pdf>
5. Savchik EN, Manakova IA, Levshina VV. Instruments of quality management as mechanism of innovative management of the organization. Econ Entrep. 2017;8-1:700–4. Russian.
6. ISO 9001:2015(R). Quality management system. Requirements: registration number: 8322/ISO/; registration date: 30.10.2015 / ROSSTANDART. Moscow; 2015. 43 p. Russian.
7. Skripko LE, Jurkina E. ISO 9001:2015: domino effect. Methods Qual Manag. 2015;7:51–3. Russian.
8. Neave HR. Organization as a system: Principles of business steady creation of Edwards Deming. Moscow: Alpina Business of Books; 2007. 370 p. Russian.
9. Zakirova AR. Process Control. Kazan: Kazan University; 2015. 86 p. Russian.
10. Manakova I, Savchik EN, Levshina VV. Introduction of electronic archive as a tool to ensure the quality of preservation of documented information [Internet]. Actual problems of Economics and management in the XXI century: collection of scientific articles of the III International scientific-practical conference. Part 2. Novokuznetsk; 2017:72–6. Russian. Available from: <http://library.sibsiu.ru/LibrPublicationsSectionsPublicationsFiles.asp?IngSection=91&IngPublication=256>

# POOR KNOWLEDGE OF THE HARMFUL EFFECTS OF SHISHA AMONG SHISHA SMOKERS: FINDINGS FROM A PRELIMINARY SURVEY IN NORTHWEST NIGERIA

Kehinde Kazeem Kanmodi<sup>1,3</sup>, Faruk Abdullahi Mohammed<sup>2,4</sup>, Njideka Jacob Nwafor<sup>1,2</sup>, Omotayo Francis Fagbule<sup>1,3,5</sup>, Miracle Ayomikun Adesina<sup>1,3</sup>, Bashar Muhammad Aliyu<sup>2</sup>, Precious Ayomide Ogundipe<sup>1,6</sup>

<sup>1</sup>Campaign for Head and Neck Cancer Education (CHANCE) Program, Cephas Health Research Initiative Inc, Ibadan, Nigeria

<sup>2</sup>Kebbi State Medical Centre, Kalgó, Nigeria

<sup>3</sup>Planning Research and Statistics Unit, Mental and Oral Health Development Organization, Sapele, Nigeria

<sup>4</sup>Department of Oral and Maxillofacial Surgery, Jaipur Dental College, Maharaj Vinayak Global University, Jaipur, Rajasthan, India

<sup>5</sup>Department of Periodontology and Community Dentistry, University of Ibadan, Ibadan, Nigeria

<sup>6</sup>Department of Statistics, Federal University of Technology, Akure, Nigeria

## Abstract

**Background:** Tobacco smoking is an addictive behavior with heavy risks accompanying its prolonged practice. Unfortunately, more and more people are indulging in tobacco smoking habits despite the public health education programs going on worldwide about the dangers associated with tobacco smoking behavior. This study aims to survey active shisha smokers in Birnin Kebbi Local Government Area (LGA), Kebbi State, Nigeria, on the awareness of the harmful effects associated with shisha smoking.

**Methods:** This study was a survey of 45 active shisha smokers in Birnin Kebbi LGA. Snowballing technique was adopted in participants' recruitment. Study instrument was a questionnaire. Data collected was analyzed using SPSS version 20 software.

**Results:** Majority (32/45) of the participants were males, 16 had secondary school education, and 19 were within age range of 15 to 24 years. The majority (25/45) of them began to smoke shisha at the age of 18 years or more; also, 20 participants smoked shisha in all the 30 days prior to their participation in this study. Less than half of the study participants knew that: shisha is a stimulant (6/45), shisha smoke contains carbon monoxide (10/45), and the liquid in shisha could be replaced with alcohol (15/45). However, more than half of the participants knew that shisha contains nicotine (23/45) and tobacco (25/45). Only 16, 13, 11, 9, 5, 10, and 13 participants knew that shisha smoking could lead to cancer, cardiovascular diseases, increase in the risk of infections, reduced baby weight in pregnancy, gum and mouth disease, eye disease and blindness, and harm to non-smokers, respectively.

**Conclusion:** Many of the active shisha smokers surveyed in this study began smoking shisha at a young age. Also, a significant proportion of them were unaware of the health hazards associated with shisha use; hence the need to educate them and even the Nigerian public on the dangers associated with shisha use.

## Keywords

Shisha • water-pipe • hookah • tobacco • smoking • knowledge • risk factors • youth • Nigerian

## Introduction

Tobacco smoking is an addictive behavior with heavy risks accompanying its prolonged practice [1-3]. Some of these risks include mental illnesses, cancers, diabetes mellitus and hypertension [1-3]. Unfortunately, more and more people are indulging in tobacco smoking habits despite the public health education programs going on worldwide about the dangers associated with tobacco smoking behavior [4, 5].

There are so many kinds of psychoactive substances that are being smoked among people; however the top two substances

that are smoked are tobacco and marijuana [6, 7]. Tobacco, which is the most predominant of all smoked psychoactive substances, is smoked in various ways, in the form of cigarette, pipe, cigar, bidis, kreteks or shisha (waterpipe) [8]. Of the forms of tobacco smoking practices, cigarette smoking is considered to be the most popular of all [9]. Furthermore, a significant proportion of cigarette smokers, after knowing full well that cigarette contains harmful tobacco, found it highly difficult to quit the behavior due to its addictive effect [10, 11].

In Nigeria, shisha smoking is gaining more and more popularity on daily basis [12]. In fact, based on some information we gathered on shisha (from one-on-one enquiries), many people in our environment usually say, erroneously, that shisha does not contain tobacco in any form; however they do say that shisha contains flavor only. Hence, it could be assumed that the Nigerian public is massively unaware of the harms associated with shisha smoking. To crown it all, only very little data are available on issues related to shisha smoking among Nigerians; hence making shisha use an issue of public health concern.

This study aims to survey a pilot sample of active shisha smokers in Birnin Kebbi Local Government Area (LGA), Kebbi State, Nigeria, on their awareness of the harmful effects associated with shisha smoking. This study is of high significance as it reveals vital information on this minimally researched area (i.e. shisha smoking), which is of public health concern.

## Methods

This study was a survey of 45 young active shisha smokers in Birnin-Kebbi LGA, Kebbi State, Nigeria, which was conducted under compliance with the Helsinki Declaration on health research involving human subjects.

Birnin Kebbi is the capital of Kebbi State, North-western Nigeria. Based on the 2006 population statistics, Birnin Kebbi has a total population of about 268,620 people of which about 50.3% of them are people aged 15 to 64 years [13]. The majority of the inhabitants of the town were Muslims and of the Hausa-Fulani tribe [14].

The study instrument was a paper questionnaire developed from literatures on tobacco smoking practices [12, 15, 16, 17-22]. The questionnaire had four sections – consent form, demographic section, section exploring shisha smoking history, and a section assessing knowledge of harms associated with shisha smoking.

Being a pilot survey which is the first of its kind in Nigeria (to the best of the authors' knowledge) coupled with the relative newness of shisha smoking practice in Nigeria, a convenient sample size of 45 active shisha smokers was used as the minimum sample size for the study. Also, due to difficulty in locating active shisha smokers independently, authors adopted the use of snowballing technique – a form of non-probability sampling technique in which existing study participants recruit future participants from the pool of their acquaintances.

The eligibility criteria for participant selection were: self-identification as an active shisha smoker, with evidence; literacy; and willingness to participate in the study.

The participants were approached on a one-on-one basis. They were well-informed about the aims and objectives of the study. They were also informed that their participation was completely voluntary, harmless, and strictly confidential. All participants gave verbal informed consent prior to participation. All questionnaires were self-administered. After their participation, the surveyed shisha smokers were given health education about the health problems associated with shisha use; hence making them knowledgeable about the health risks associated with shisha use.

A total of 45 out of the 50 active shisha smokers that were contacted agreed to participate in the study. All questionnaires were self-administered. After data cleaning, no questionnaire was found unfit for analysis as all questionnaires were properly filled. The collected data were coded, computed and analyzed using the SPSS Version 20 Software. The frequencies of the qualitative variables were determined. Results of data analysis were presented using tables.

## Results

Out of the 50 active shisha smokers that were contacted, only 45 gave consent to participate in this study, giving a response rate of 90%.

Majority (32/45) of the study participants were males, 28 were Hausas, 33 were Muslims, 16 had secondary school education, 24 had monogamous family background, 18 were living in a room-and-parlor apartment, and 19 were within age range of 15 to 24 years (Table 1).

The majority (25/45) of the participants began to smoke shisha at the age of 18 years or more. Also, 20 of them smoked shisha in all the 30 days prior to their participation in this study (Table 2).

Less than half of the study participants knew that: shisha is a stimulant (6/45), shisha smoke contains carbon monoxide (10/45), and the liquid in shisha could be replaced with alcohol (15/45). However, more than half of them knew that shisha contains nicotine (23/45) and tobacco (25/45) (Table 3).

Only 16, 13, 11, 9, 5, 10, and 13 participants knew that shisha smoking could lead to cancer, cardiovascular diseases, increase in the risk of infections, reduced baby weight in pregnancy, gum and mouth disease, eye disease and blindness, and harm to non-smokers, respectively (Table 3).

Lastly, only 2 participants knew that there was medical evidence that had shown that shisha has harmful effect on health (Table 3).



## Discussion

Over the years, shisha smoking has become an issue of global health concern [17]. In fact, the prevalence of shisha smoking is on the rising side [17]. Interestingly, peer influence, parental influence, socio-cultural acceptance of shisha smoking behavior are factors implicated in the migration of more and more people, who were previously non-smokers of shisha, to the pool of shisha smokers [15].

Shisha smoke is rich in flavored tobacco, polycyclic aromatic hydrocarbons, volatile aldehydes (such as formaldehyde, acetaldehyde, acrolein, propionaldehyde, and methacrolein), carbon monoxide, nitric oxide, nicotine, furans, and nanoparticles [16-21]. Polycyclic aromatic hydrocarbons are potent carcinogens which a significant exposure to them could induce malignancies in the body [20]. Also, the volatile hydrocarbons in shisha smoke have been strongly associated with lung cancers, respiratory tract irritation, chronic obstructive pulmonary disorder, coronary artery disease, arrhythmia, and more [21]. The carbon monoxide in shisha smoke can also cause carbon monoxide poisoning among its users. Also, through the sharing of the mouthpiece of shisha, infections such as hepatitis B, tuberculosis can be transmitted [18].

Unfortunately, many shisha smokers wrongly perceived shisha smoke to have little to no risk compared to cigarette smoking; hence, making so many shisha smokers to have a wrong feeling of being spared from the health problems associated with cigarette use [8, 15, 22, 23].

However, only few published studies on shisha had ever been conducted among Nigerian population groups and out of these few, only scanty information were provided on the knowledge of health risks associated with shisha smoking among shisha smokers [12, 24]; this shows the imperative need to explore the knowledge of the general public on the health hazards associated with this kind of smoking behavior.

In this study, we only surveyed a pilot sample of active shisha smokers domiciled in Birnin Kebbi LGA, Kebbi State, Nigeria, on their knowledge of the health risks associated with shisha smoking. From our study data, we observed that a significant proportion of our participants lacked adequate knowledge of the health risks associated with shisha smoking (Table 3). This finding is somewhat similar to that reported among some shisha smokers in Kampala (Uganda), Buraidah (Saudi Arabia), Shah Alam (Malaysia) [25-27].

The knowledge gaps on shisha constituents, as recorded among the participants in this present study, reveal a public health emergency (Table 3). A very significant proportion of

them demonstrated poor knowledge of the toxic constituents of shisha as many of them did not know that shisha smokes contain nicotine and carbon monoxide. This finding is similar to that reported among shisha smokers in Malaysia and Indonesia [28, 29].

Also, as high as 18 (out of a total of 45) participants started smoking shisha at age below 18 years; this reveal that they stand at a very high risk of developing tobacco-induced diseases if they continue to indulge in shisha smoking. Furthermore, our finding on age of smoking debut is similar with that reported among shisha smokers in Gujarat (India) and Karachi (Pakistan) [30, 31].

However, this study has its limitations. First, the sample size used for this study was small; however we used such small sample size because of the difficulty in recruiting current shisha smokers due to problems with accessibility and limited funding for the study. Second, this study adopted the use of snowballing technique (a non-probability sampling technique) in the recruitment of its participants; hence not all potential participants were given equal chance of being selected to partake in the study. Third, this study only surveyed current shisha smokers located in Birnin Kebbi LGA, Kebbi State; shisha smokers in other LGAs were not surveyed in this study. This makes it difficult to make generalizations about shisha smokers in Kebbi State, coupled with the sampling technique adopted for the study.

In conclusion, this study had shown that shisha smoking habits commonly begin at a juvenile age. Also, this study reveals that a significant proportion of shisha smokers in Birnin Kebbi are unaware of the health hazards associated with shisha use. This study also shows the need to educate the Nigerian public on the dangers associated with shisha smoking habits.

## Acknowledgements

This study forms part of the research projects of the Campaign for Head and Neck Cancer Education (CHANCE) Program run by the Cephas Health Research Initiative Inc, Ibadan, Nigeria [12,32-34]. We appreciate those shisha smokers who partook in this study.

## Conflict of Interest Statement

This study was self-funded. Authors have no conflict of interest to declare.



## References

1. Saha SP, Bhalla DK, Whayne TF, Gairola CG. Cigarette smoke and adverse health effects: An overview of research trends and future needs. *Int J Angiol*. 2007;16(3):77–83.
2. Aslam HM, Saleem S, German S, Qureshi WA. Harmful effects of shisha: literature review. *Int Arch Med*. 2014;7:16. <https://doi.org/10.1186/1755-7682-7-16>
3. Mishra A, Chaturvedi P, Datta S, Sinukumar S, Jeshi P, Garg A. Harmful effects of nicotine. *Indian J Med Paediatr Oncol*. 2015;36(1):24–31. <https://dx.doi.org/10.4103%2F0971-5851.151771>
4. Tahlil T, Woodman RJ, Coveney J, Ward PR. The impact of education programs on smoking prevention: a randomized controlled trial among 11 to 14 year olds in Aceh, Indonesia. *BMC Public Health*. 2013;13:367. <https://dx.doi.org/10.1186%2F1471-2458-13-367>
5. Agaku I, Akinyele A, Oluwafemi A. Tobacco control in Nigeria – policy recommendations. *Tob Induc Dis*. 2012;10:8. <https://dx.doi.org/10.1186%2F1617-9625-10-8>
6. New Psychoactive Substances (NPS) [Internet]. Singapore: Central Narcotics Bureau; 2017 Sep 18 [cited 2018 Dec 17]. Available from: <https://www.cnb.gov.sg/educational-resources/for-youths/articles/article/Index/new-psychoactive-substances-%28nps%29>
7. Peacock A, Leung J, Larney S, Colledge S, Hickman M, Rehm J, et al. Global statistics on alcohol, tobacco and illicit drug use: 2017 status report. *Addiction*. 2018;113:1905–26. <https://doi.org/10.1111/add.14234>
8. O'Connor RJ. Non-cigarette tobacco products: What have we learned and where are we headed? *Tob Control*. 2012;21(2):181–90. <https://doi.org/10.1136/tobaccocontrol-2011-050281>
9. Liang Y, Zheng X, Zeng DD, Zhou X, Leischow SJ, Chung W. Exploring How the Tobacco Industry Presents and Promotes Itself in Social Media. *JMIR*. 2015;17(1):e24. <https://doi.org/10.2196/jmir.3665>
10. Petruoulia I, Vardavas C, Fillippidis F, Peleki T, Behrakis P, Quah ACK, et al. The association between the awareness of the effects of smoking/secondhand smoke and the desire to quit. *Tob Induc Dis*. 2018;16(Suppl 1):A710. <https://doi.org/10.18332/tid/84622>
11. Oncken C, Mckee S, Krishnan-Sarin S, O'Malley S, Mazure CM. Knowledge and perceived risk of smoking-related conditions: a survey of cigarette smokers. *Prev Med*. 2005;40(6):779–84. <https://doi.org/10.1016/j.ypmed.2004.09.024>
12. Kanmodi KK, Fagbule OF, Aladelusi TO. Prevalence of shisha (waterpipe) smoking and awareness of head and neck cancer among Nigerian secondary school students: A preliminary survey. *Int Public Health J*. 2018;10(2):209–14.
13. City Population. Birnin Kebbi [Internet]. [cited 2018 Dec 17]. Available from: <https://www.citypopulation.de/php/nigeria-admin.php?adm2id=NGA022006>
14. Encyclopaedia Britannica. Birnin Kebbi: Nigeria [Internet]. [cited 2018 Dec 17]. Available from: <https://www.britannica.com/place/Birnin-Kebbi>
15. van der Merwe N, Banoobhai T, Gqweta A, Gwala A, Masiea T, Misra M, et al. Hookah pipe smoking among health sciences students. *S Afr Med J*. 2013;103(11):847–9. <https://doi.org/10.7196/samj.7448>
16. Meo SA, AlShehri BB, Barayyan OR, Bawazir AS, Al-nazi OA, Al-Zuhair AR. Effect of shisha (waterpipe) smoking on lung functions and fractional exhaled nitric oxide (FeNO) among Saudi young adult shisha smokers. *Int J Environ Res Public Health*. 2014;11(9):9638–48. <https://dx.doi.org/10.3390%2Fijerph110909638>
17. Mizek R, Patte C. Carbon monoxide toxicity after lighting coals at a hookah bar. *J Med Toxicol*. 2014;10(3):295–98. <https://dx.doi.org/10.1007%2Fs13181-013-0368-x>
18. Kadhum M, Sweidan A, Jaffery AE, Al-Saadi A, Madden B. A review of health effects of smoking shisha. *Clin Med (Lond)*. 2015;15(3):263–6.
19. Cobb CO, Sahmarani K, Eissenberg T, Shihadeh A. Acute toxicant exposure and cardiac autonomic dysfunction from smoking a single narghile waterpipe with tobacco and with a “healthy” tobacco-free alternative. *Toxicol Lett*. 2012;215:70–5. <https://doi.org/10.1016/j.toxlet.2012.09.026>
20. Sepetdjian E, Saliba N, Shihadeh A. Carcinogenic PAH in waterpipe charcoal products. *Food Chem Toxicol*. 2010;48:3242–5. <https://doi.org/10.1016/j.fct.2010.08.033>
21. Hammal F, Chappell A, Wild TC, Kindzierski W, Shihadeh A, Vanderhoeck A, et al. 'Herbal' but potentially hazardous: an analysis of the constituents and smoke emissions of tobacco-free waterpipe products and the air quality in the cafes where they are served. *Tob Control*. 2015;24(3):290–7. <https://doi.org/10.1136/tobaccocontrol-2013-051169>
22. Dawood OT, Rashan MAA, Hassali MA, Saleem F. Knowledge and perception about health risks of cigarette smoking among Iraqi smokers. *J Pharm Bioallied Sci*. 2016;8(2):146–51. <https://dx.doi.org/10.4103%2F0975-7406.171738>
23. Arab Health. The shisha habit: a global epidemic [Internet]. 2018 [cited 2018 Dec 01]. Available from: <https://www.arabhealthonline.com/magazine/en/latest-issue/2018-issue-6/the-shisha-habit-global-epidemic.html>
24. Aniwada EC, Uleanya DN, Ossai EN, Nwobi EA, Anibueze M. Tobacco use: prevalence, pattern, and predictors, among those aged 15–49 years in Nigeria, a secondary data analysis. *Tob Induc Dis*. 2018;16:7. <https://doi.org/10.18332/tid/82926>
25. Aanyu C, Ddamulira JB, Nyamurungi K, Ediau M, Bazeyo W. Knowledge, attitudes and practices of Shisha smoking among youths in Kampala, Uganda. *Tob Induc Dis*. 2018;16(Suppl 1):A484. <https://doi.org/10.18332/tid/84307>

26. Al-Naggar RA, Bobryshev YV, Anil S. Pattern of shisha and cigarette smoking in the general population in Malaysia. *Asian Pac J Cancer Prev.* 2014;15(24):10841–6.
27. Muzammil, Al Asmari DS, Al Rethaiaa AS, Al Mutari AS, Al Rashidi TH, Al Raheedi HA, et al. Prevalence and perception of shisha smoking among university students: a cross-sectional study. *J Int Soc Prev Community Dent.* 2019;9(3):275–81. [https://dx.doi.org/10.4103/jispcd.JISPCD\\_407\\_18](https://dx.doi.org/10.4103/jispcd.JISPCD_407_18)
28. Wong LP, Alias H, Aghamohammadi N, Aghazedah S, Hoe VCW. Shisha Smoking Practices, Use Reasons, Attitudes, Health Effects and Intentions to Quit among Shisha Smokers in Malaysia. *Int J Environ Res Public Health* 2016;13(7):E726. <https://dx.doi.org/10.3390/ijerph13070726>
29. Fauzi R, Areesantichai C. Knowledge toward health risk of shisha use among high school students in Jakarta, Indonesia. *J Health Res [Internet].* 2015[cited 2019 Jan 4];29(Suppl.2):S229–32. Available from: <https://www.tci-thaijo.org/index.php/jhealthres/article/view/78052>
30. Rami K, Makvana BJ, Thakor NC. Knowledge, attitude and practices of hookah smoking among medical students in Gujarat, India: a cross sectional study. *Int J Adv Med.* 2015;2(4):397–400. <http://dx.doi.org/10.18203/2349-3933.ijam20151017>
31. Anjum Q, Ahmed F, Ashfaq T. Knowledge, attitude and perception of water pipe smoking (Shisha) among adolescents aged 14-19 years. *J Pak Med Assoc.* 2008;58(6):312–7.
32. Mohammed FA, Kanmodi KK, Fagbule OF, Adesina MA, Njideka NJ, Sadiq HA. Shisha smokers' desire to quit shisha smoking habit: findings from a Nigerian pilot survey. *Glob Psychiatr.* 2019;2(1):1–5. <https://doi.org/10.2478/gp-2019-0004>
33. Fagbule OF, Kanmodi KK, Aladelusi TO. Secondhand tobacco smoke exposure and attitudes towards tobacco ban: A pilot survey of secondary school students in Ibokun Town, Nigeria. *Int J Child Adolesc Health.* 2018;11(3):349–53.
34. Adesina MA, Kanmodi KK, Fagbule OF, Ogunmuko T. Unfavorable family background is associated with smoking at youthful age. *Int J Child Health Hum Dev.* 2019;12(2). [Epub ahead of print].

**Table captions**

**Table 1.** Socio-demographic attributes of the participants

<b>Attributes</b>	<b>Frequency</b>	<b>%</b>
<b>Gender</b>	n (45)	
Male	32	71.1
Female	13	28.9
<b>Level of Education</b>	n (43)	
Secondary School	16	37.2
Above Secondary School	27	62.8
<b>Age (category)</b>	n (45)	
15 - 24 years old (Youth)	19	42.2
25 - 40 years old	26	57.8
<b>Religion</b>	n (45)	
Islam	33	73.3
Non-Islam (Christianity + Others)	12	26.7
<b>Tribe (Hausa and Non-Hausa)</b>	n (45)	
Hausa	28	62.2
Non-Hausa	17	37.8
<b>Family Background</b>	n (42)	
Monogamous	24	57.1
Polygamous	10	23.8
Polyandry	5	11.9
Single Parent	3	7.1
<b>Where do you live?</b>	n (42)	
One room apartment	14	32.6
Room-and-parlor apartment	18	41.90
Flat with at least two rooms	10	23.30
Others	1	2.30

*n* – Number of participants that responded to the variable

**Table 2.** Age of shisha smoking debut and recent history of shisha smoking

<b>Age when you first smoked shisha</b>	n (43)	
10 years or below	1	2.30
11 - 15 years	4	9.30
16 - 17 years	13	30.20
18 years or more	25	58.10
<b>During the past one month, how many days did you smoke shisha?</b>	n (45)	
0 days	5	11.1
1 or 2 days	2	4.4
3 to 5 days	8	17.8
6 to 9 days	5	11.1
10 to 19 days	5	11.1
All 30 days	20	44.4

*n* – Number of participants that responded to the variable

**Table 3.** Knowledge of participants on the harm associated with shisha use

Variables	Frequency	%
<b>Shisha is not a stimulant</b>	n (42)	
No	6	14.3
yes / I don't know	36	85.7
<b>Shisha contains nicotine</b>	n (45)	
no / I don't know	22	48.9
Yes	23	51.1
<b>Shisha contains tobacco</b>	n (45)	
no / I don't know	20	44.4
Yes	25	55.6
<b>Smoke from shisha does not contain carbon monoxide</b>	n (44)	
No	10	22.7
yes / I don't know	34	77.3
<b>Liquid in shisha can be replaced with alcohol</b>	n (43)	
no / I don't know	28	65.1
Yes	15	34.9
<b>Shisha use has been linked with cardiovascular diseases</b>	n (44)	
no / I don't know	31	70.5
Yes	13	29.5
<b>Shisha use has not been linked cancer</b>	n (44)	
No	16	36.4
yes / I don't know	28	63.6
<b>Shisha use increases the risk of infections</b>	n (45)	
no / I don't know	34	75.6
Yes	11	24.4
<b>Shisha use in pregnancy reduces baby weight</b>	n (43)	
no / I don't know	34	79.1
Yes	9	20.9
<b>Shisha use has been linked with gum and mouth disease</b>	n (43)	
no / I don't know	38	88.4
Yes	5	11.6
<b>Shisha use has not been linked with eye disease and blindness</b>	n (45)	
No	10	22.2
yes / I don't know	35	77.8
<b>Other peoples' shisha use cannot harm non-smokers</b>	n (45)	
No	13	28.9
yes / I don't know	32	71.1
<b>No medical evidence that shisha could harm one's health</b>	n (19)	
No	2	10.5
yes / I don't know	17	89.5

*n* – Number of participants that responded to the variable

# LATE COGNITIVE IMPAIRMENT AFTER CORONARY BYPASS GRAFT SURGERY: OPPORTUNITIES IN REHABILITATION WITH THE USE OF COMPUTER-BASED TRAINING

M. Petrova<sup>1</sup>, S. Prokopenko<sup>1</sup>, O. Eryomina<sup>1</sup>, E. Mozheyko<sup>1</sup>, D. Kaskaeva<sup>1</sup>, O.A. Gavrilyuk<sup>1</sup>, S. Eryomina<sup>2</sup>

<sup>1</sup>Prof. V.F. Voino-Yasenetsky Krasnoyarsk State Medical University, Krasnoyarsk, Russian Federation

<sup>2</sup>N.I. Pirogov Russian National Research Medical University, Moscow, Russian Federation

## Abstract

In spite of recent significant advances in reduction of mortality and disability, coronary heart disease (CHD) remains widespread both in Russia and around the world. Coronary bypass graft surgery (CABG) has proved to be the most effective method of CHD treatment, providing that conservative therapy is not effective enough. The aim of the present study was to reveal and correct postoperative cognitive dysfunction (POCD), developed under the conditions of cardiopulmonary bypass (CB) in patients with CHD within 12 months after CABG.

A total of 87 patients were examined, all the patients underwent a course of drug therapy, 50 patients underwent a course of rehabilitation using computer-based stimulation programmes (once per day for 20 minutes within 10 days) in addition to medical therapy. A reliable improvement in results of the conducted research suggests that the proposed method provides safety and high performance in cognitive rehabilitation of patients with impairments of the higher brain functions after CABG. A relatively short course of rehabilitation (10 days) corresponded to the length of hospital stay of patients in the cardiac unit. However, even in such a short course we could obtain significant advantage in terms of efficiency of higher cortical functions recovery. Therefore, a course of rehabilitation using computer-based stimulation programmes in patients with coronary heart disease after CABG was proved to be an effective way of correcting cognitive function.

## Keywords

coronary heart disease • cognitive impairment • coronary artery bypass surgery • computer-based stimulation programme

## Introduction

In spite of recent significant advances in reduction of mortality and disability, coronary heart disease (CHD) remains widespread both in Russia and around the world [1, 2]. Coronary bypass graft surgery (CABG) has proved to be the most effective method of CHD treatment, providing that conservative therapy is not effective enough [2].

Recent developments in surgery, diagnostics, anaesthesiology, cardiopulmonary bypass (CB), and critical care medicine have led to decline in number of post-operative complications and mortality cases in cardiovascular surgery and made the surgical indications significantly extended. Prevention of neurological complications after cardiac interventions and reparative vascular surgical interventions remains one of the most important challenges for both neurology and cardiovascular surgery.

With the constant development in surgical techniques the number of severe post-operative central nervous system

disorders has reduced [1]. However, from 20 to 80 % of patients after cardiac interventions still develop POCD [2,3], which has become a marker of patient's low quality of life, financial dependence from relatives and state and a poor life prognosis [4,5]. This fact is of particular importance for those patients with POCD who are of working age, because the development of POCD complicates the process of recovery, decreases the effectiveness of rehabilitation measures and often the chances of patients' returning to work [6].

The modern concept of POCD consists in development of impairment of the higher cortical functions (memory, attention, thinking, speech, etc.) in the early postoperative periods and they also are preserved in the late postoperative periods [3,4,7]. Due to the inhomogeneity of the studies, data on the incidence of POCD is contradictory. In the research of Van Dijk and colleagues the frequency of POCD 2 months after CABG



was in the range of 4 to 47%. However, other works reported a higher frequency of neuropsychological impairment in the early postoperative period (from 30 to 83%) [8,9]. Research over the last five years indicates that the frequency of development of early POCD remains rather high - from 38 to 60% in 2 weeks and from 30 to 40% - in 8-10 weeks after CABG [10 - 12]. The fact that before the surgery a significant portion of patients with coronary heart disease (CHD) had cognitive disorders of various levels of severity is important for understanding the changes in cognition after CABG.

According to the literature data, the frequency of preoperative cognitive impairment ranges from 20 to 40%. This frequency depends on the age of the presence or absence of hypertension, cerebrovascular disease, genetic predisposition and the level of education [6]. The majority of the works presented in the modern literature are devoted to short-term neuropsychological outcomes. Whereas the works devoted to the long-term neuropsychological outcomes after CABG performed with the use of CB are not so numerous. Perhaps this is due to the fact that among researchers in this area, it is believed that the development of postoperative cognitive dysfunction is reversible. They believe that after a certain time interval, the cognitive function is recovered. Thus, Selnes compared the indexes of the cognitive status of patients with an ischemic heart disease after CABG and without surgical intervention. Significant distinctions between groups were not received [3]. Changes in the cognitive sphere were observed equally in both groups. Based on these results, the authors concluded that surgery did not affect the patient's cognitive status. Newman and colleagues in their work showed that five years after CABG performed with the use of CB, the incidence of persistent POCD was 40% [13]. Cognitive decline from presurgical level in 5 years after CABG was observed in four cognitive domains - memory, attention, psychomotor speed and abstraction [4,13]. Thus, currently, there are no generally accepted criteria for the diagnosis of POCD, its structure is not clear, there are no convincing data on dynamics of its indices within a year, there is no unified approach to neuropsychological testing conducting and there is no unified approach to the assessment of the severity of cognitive impairment in patients who underwent CABG with the use of CB.

Results of the reviews devoted to rehabilitation of patients with cognitive impairment in case of cerebrovascular pathology are published [14]. Some works are devoted to the application of computerized training of memory, attention and visual gnosis [7,15].

Considering common features of a pathogenesis of vascular and post-operational cognitive disorders, a certain modification of the classes provided, computerized training might be used in patients undergoing CABG. A method of correction of cognitive impairments in case of cerebrovascular pathology with use of the computer-based stimulation programmes

(CSPs) was developed by the staff of the Department of nervous diseases with a course of medical rehabilitation of Professor V.F. Voyno-Yasenetsky Krasnoyarsk State Medical University (patent number 2438574, 2012) [10, 16].

The proposed CSPs included sets of the structured, standardized and well-designed tasks for neuropsychological correction that could be performed using a personal computer. To ensure computer-based neuropsychological correction we used the visual memory training programmes with a sequence of tasks for memorizing difficult verbalized symbols, the Clock-Drawing Test for optical spatial arrangement gnosis training, the programme for impulsivity and attention span correction, as well as the programme for training counting ability. All the programmes provided the choice of exercises of the given level of complexity and duration and allowed the patient to get a quick feed-back. The described CSPs could be used at home and, consequently, were available to patients with severe physical handicaps.

We published papers on the use of CSPs in patients with CHD in the early postoperative period following CABG [7, 10, 16].

The rehabilitation course with use of CSPs within 10 days once a day (provided that the duration of one session is 20 minutes), proved to be an efficient way to correct cognitive impairments of a vascular genesis [7, 10, 16]. According to previously obtained data, the use of computer-based training in the early postoperative period promotes regression of postoperative cognitive impairment in patients who underwent CABG [7].

The aim of the study was to evaluate the effectiveness of using CSPs in the correction of early and late cognitive impairment in patients with coronary heart disease after CABG.

## Methods

A total of 87 male and female patients with coronary heart disease were examined on the premises of the Federal centre for cardiovascular surgery (Krasnoyarsk).

The inclusion criteria for the treatment group included:

1. Age up to 70 years.
2. Prescheduled coronary bypass surgery.
3. Signed Informed Consent.

The exclusion criteria comprised:

1. The presence of chronic obstructive lung disease, chronic renal failure, oncopathology.
2. Combination of coronary heart disease with valvular disease, diabetes mellitus of any type, atrial fibrillation, brachiocephalic arterial occlusive disease or acute cerebrovascular accident in past medical history.
3. Less than 24 pre-operative indices on the Mini Mental State Examination scale and/or less than 11 pre-operative indices of the Frontal Assessment Test Battery.
4. Patient's refusal to participate in the study.

All the patients were divided into two groups. The main group (n=50) included patients who underwent a course of rehabilitation with the use of CSPs (1 time per day for 20 min. within 10 days) in addition to usual medical therapy. The course was started within the second twenty-four hours after coronary bypass surgery. The control group included 37 patients who underwent a course of post-operative rehabilitation getting usual medical therapy. The average age of main group patients made  $60.3 \pm 6.83$  years with a median value of 62 years [57; 69]; the average age of the control group patients made  $60.5 \pm 6.42$  years with a median value of 61 years [55; 66] ( $p > 0.05$ ).

The pre-operative examination comprised general somatic examination, methods of functional diagnostics (echocardiography, duplex scanning of brachiocephalic arteries), neuropsychological testing.

The diagnosis of coronary heart disease was confirmed based on the WHO criteria, the presence of anginal thoracalgia or its equivalent, patients' medical history and instrumental methods of analysis. The estimation of the functional class of angina was made following the Canadian Cardiovascular Society Angina Classification (CCS, 1976). To reveal the stage of cardiac failure (CF) the classification after N.D. Strazhesko and V.H. Vasilenko (1935) was used. The estimation of the functional class of CF was made following the New York Heart Association (NYHA, 1964) classification. The severity of angina corresponded to the II-III functional class (see Table 1).

The patients were examined with the use of a standard scheme for neurological examination. Patients with mild cognitive impairments were included in the study according to the criteria formulated by R. Peterson (Peterson, 1997).

Cognitive deficiency was revealed with the use of the MMSE scale, according to which the number of points less than 28 is indicative of a moderate cognitive disorder [17, 18].

Cognitive functioning was estimated with the use of the Frontal Assessment Test Battery [19], the Clock Drawing Test [20], mental capacity and psychic pace examination (Schulte Tables) [17], spontaneous and tardy reproduction of acoustic and visual material [19], association test (semantic speech activity) [21], serial counting test from the Mattis Dementia Rating Scale (Digitspan, WAIS). The technique of overlearning of 10 words was applied in several steps. The first step included words' overlearning on the first presentation, the second one involved complete reproduction with five repetitions, and the third one implied a tardy reproduction [22]. The emotional state of the patients was estimated with the use of the Hospital Anxiety and Depression Scale (HADS). POCD was defined as a decrease of least 20% from baseline in an individual's performance in more than two neuropsychological tests [23].

All the patients underwent CABG performed with the use of CB. Anaesthesia and perfusion were conducted conventionally. In the main group the CB duration made  $86.9 \pm 39.1$  minutes, the aortic cross-clamping time –  $50.9 \pm 33.0$  мин. ( $p > 0.05$ ). In the control group the CB duration made  $83.2 \pm 32.6$  minutes ( $p > 0.05$ ), the aortic cross-clamping time –  $50.1 \pm 28.3$  ( $p > 0.05$ ) (see Table 1).

As it is shown in Table 1, according to the EuroSCORE, no statistically significant differences between the two groups were found in respect to age, CB period, angina functional class and EuroSCORE.

**Table 1.** Clinical-demographic indicants of patients with coronary heart disease

Criteria	Group with the use of CSPs	Control group	p
Age, years	62 [ 57.0; 69.0]	61.0 [55.0; 66.0]	>0.05
CB duration	76.0 [64.0; 92.0]	74.0 [64.0;92.0]	>0.05
Aortic cross-clamping time	40.0 [33.0; 60.0]	39.5 [28.0; 58.0]	>0.05
Functional class, abs. %			
II	26 (56)	21 (56.7)	
III	24 (48)	16 (43.3)	
Functional class (NYHA), abs. %			
II	24 (48)	18 (48.6)	
III	26 (52)	19 (51.4)	
Number of patients with old myocardial infarction, abs. (%)	25 (67.6)	27 (73)	
Number of patients - smokers, n (%)	35 (70)	28 (76)	
Education, abs. (%) secondary	13 (26)	11 (29.7)	
vocational secondary	24 (48)	17 (46)	
higher	13 (26)	9 (24.3)	
EuroSCORE	$2.89 \pm 1.32$	$3.0 \pm 1.2$	>0.05

Note: abs. - absolute

During the post-operative period, within 6-12 months after surgical intervention, similar examinations were performed: general somatic examination, methods of functional diagnostics (echocardiography, duplex scanning of brachiocephalic arteries), neuropsychological testing.

Statistical data processing was included non-parametric methods with the use of Statistica 6.0 (Statsoft Russia). In pair-wise comparison to value the significance of the found differences between two dependent samples the Wilcoxon criterion was used, while independent samples were estimated with the use of the Mann-Whitney test. To study the association of quantitative attributes the Spearman correlation coefficient was used. Differences were considered as statistically significant at  $p \leq 0.05$ .

## Results and Discussion

Coronary artery bypass graft surgery (CABG) lead to improvement of clinical state in all patients, increase of

their tolerance to physical activity, improvement of systolic myocardial function. All patients were dismissed in satisfactory condition after 10 to 13 days.

On cardiovascular examination with duplex screening of carotid and vertebral arteries, symptoms of atherosclerosis without hemodynamically significant lesions were registered. By evaluation of central hemodynamics parameters in early postoperative period, statistically significant decrease of systolic output (SO), ejection fraction (EF), end-diastolic and end-systolic volumes were registered. In our opinion, it is associated with post-surgical "trauma" and with the aftereffect of CB. However, 12 months after CABG, improvements in both SO and EF parameters were registered. This seems to be associated with improvement of coronary blood flow; adaptive processes leading to increased physical activity and decreased post-surgical "trauma" impact. No statistically significant differences were registered among the study groups (see Tables 2, 3).

During the initial neurological examination, lesions were registered in almost all of the enrolled patients. In group

**Table 2.** Results of the echocardiogram before and after surgical treatment in the group with the use of CSPs

Parameters	Before treatment	After treatment	6 months after treatment	12 months after treatment
<b>EF (%)</b> <i>Ejection fraction</i>	50.0 [45.0;53.0]	50.0 [43.0;53.0]	52.5 [50.0;55.0]	55.0 [52.0;57.0]
	$p_1-p_2 = 0.41$ $p_2-p_3 = 0.001$ $p_3-p_4 = 0.02$ $p_1-p_4 = 0.001$			
<b>SO (ml)</b> <i>Systolic output</i>	56.5 [50.0;61.0]	52.5 [48.0;59.0]	54.5 [51.0;58.0]	64.0 [59.0;72.0]
	$p_1-p_2 = 0.06$ $p_2-p_3 = 0.68$ $p_3-p_4 = 0.98$ $p_1-p_4 = 0.001$			
<b>EDV (ml)</b> <i>End-diastolic volume</i>	114.0 [98.0;129.0]	111.5 [89.0;132.0]	123.0 [112.0;130.0]	124.0 [113.0;132.0]
	$p_1-p_2 = 0.39$ $p_2-p_3 = 0.14$ $p_3-p_4 = 0.51$ $p_1-p_4 = 0.138$			
<b>ESV (ml)</b> <i>End-systolic volume</i>	56.5 [48.0;70.0]	53.0 [44.0;66.0]	61.5 [58.0;66.0]	64.0 [59.0;72.0]
	$p_1-p_2 = 0.008$ $p_2-p_3 = 0.01$ $p_3-p_4 = 0.015$ $p_1-p_4 = 0.015$			

**Table 3.** Results of the echocardiogram before and after surgical treatment in the control group

Parameters	Before treatment	After treatment	6 months after treatment	12 months after treatment
<b>EF (%)</b> <i>Ejection fraction</i>	50.0 [46.0;53.0]	50.0 [45.0;52.0]	54.0 [51.0;56.0]	57.0 [55.0;59.0]
	$p_1-p_2 = 0.46$ $p_2-p_3 = 0.001$ $p_3-p_4 = 0.001$ $p_1-p_4 = 0.001$			
<b>SO (ml)</b> <i>Systolic output</i>	58.0 [53.0;62.0]	53.0 [48.0;59.0]	61.0 [58.0;63.0]	67.0 [62.0;74.0]
	$p_1-p_2 = 0.018$ $p_2-p_3 = 0.001$ $p_3-p_4 = 0.001$ $p_1-p_4 = 0.001$			
<b>EDV (ml)</b> <i>End-diastolic volume</i>	114.0 [106.0;130.0]	116.5 [88.0;132.0]	123.0 [114.0;130.0]	128.0 [123.0;132.0]
	$p_1-p_2 = 0.321$ $p_2-p_3 = 0.141$ $p_3-p_4 = 0.032$ $p_1-p_4 = 0.021$			
<b>ESV (ml)</b> <i>End-systolic volume</i>	59.0 [50.0;70.0]	52.0 [43.0;64.0]	61.0 [58.0;65.0]	65.0 [61.0;72.0]
	$p_1-p_2 = 0.008$ $p_2-p_3 = 0.011$ $p_3-p_4 = 0.015$ $p_1-p_4 = 0.139$			

1, impairment of memory was registered in 48 % (24/50), performance decrement was registered in 52 % (26/50), while headache and dizziness complaints were registered in 30 % (16/50). In the control group, impairment of memory was registered in 45.9 % of cases (17/37), performance decrement was registered in 54 % (20/37), and headache and dizziness complaints were registered in 24.3 % (9/37).

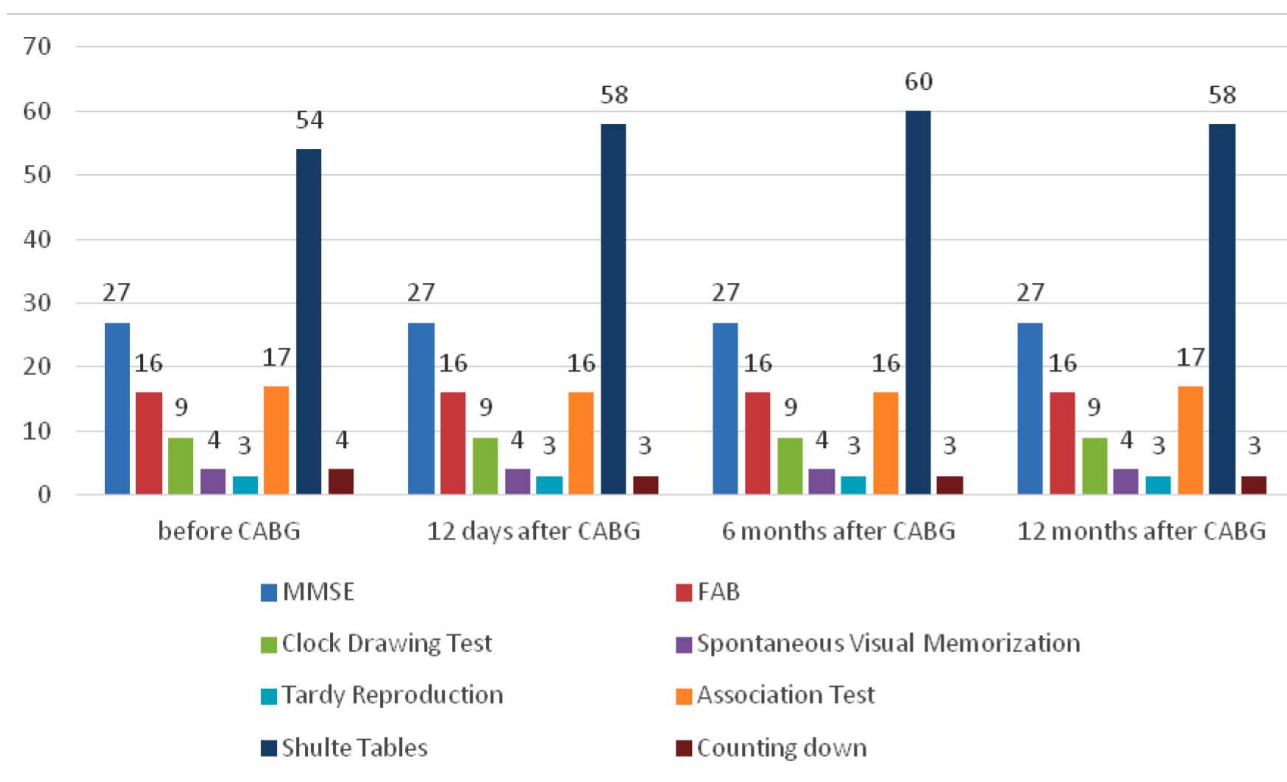
Assessing the neurological status of the persons included into the study revealed vague neurological symptoms in the form of vestibulo-ataxic impairments, pseudo-bulbar syndrome, and pyramidal signs. Cognitive function parameters at the preoperative stage were comparable in the main and the control groups (the Mann-Whitney test),  $p < 0.05$ . According to the inclusion criteria, before the treatment the level of cognitive impairment in patients of groups 1 and 2 was comparable and conformed to the level of mild cognitive impairment (MCI). For characteristics of the groups, see Table 4 and Figure 1.

In the main group of patients receiving computer-based cognitive training in addition to standard treatment during the postoperative period, statistically significant improvement was registered by day 12: on the MMSE scale

( $p = 0.001$ , Wilcoxon test), FAB ( $p = 0.007$ , Wilcoxon test), in analysis of optical memory (five words memorization) with direct reproduction ( $p = 0.012$ , Wilcoxon test) at memorizing of ten words (total number of words) ( $p = 0.001$ , Wilcoxon test) (Table 4). The parameters of direct and tardy reproduction of ten words, visual memorization of 5 words with tardy reproduction, Mattis scale serial counting and verbal fluency (lateral and categorical associations) did not show statistically significant improvement. However, these parameters remained at the preoperative level.

By test result comparison among patients of groups 1 and 2 on day 12 statistically significant differences were revealed: on the MMSE scale ( $p = 0.002$ ), FAB ( $p = 0.001$ ), tests for associative thinking ( $p = 0.001$ ), memorizing of 10 words with direct reproduction ( $p = 0.002$ ), total number of words ( $p = 0.001$ ), tardy reproduction ( $p = 0.004$ ), visual memorization of 5 words with direct reproduction, ( $p = 0.015$ ), tardy reproduction ( $p = 0.014$ ), and Shulte tables attention assessment ( $p = 0.014$ ).

12 days after the surgery in the control group a total of eight neuropsychological tests showed statistically significant deterioration (Wilcoxon test,  $p < 0.5$ ). When comparing



**Figure 1.** Dynamics of cognitive function indices after CABG in the control group patients

**Note:** Differences were considered as statistically significant at significance level  $p < 0,05$  (Wilcoxon test)

**Table 4.** Dynamics of cognitive function indices after CABG in patients who used CSPs

Neuropsychological test	Before CABG	12 days after CABG	6 months after CABG	12 months after CABG
MMSE Median value, Me [P25;P75], p (Wil.Crit.)	27.0 [26.0;28.0]  p <sub>1,2</sub> =0.001	28.0 [27.0;28.0]  p <sub>2,3</sub> =0.237	28.0 [27.0;28.0]  p <sub>3,4</sub> = 0.012	28.0 [28.0;29.0]  p <sub>1,4</sub> =0.001
FAB Median value, Me [P25;P75], p (Wil.Crit.)	16.0 [16.0;17.0]  p <sub>1,2</sub> =0.007	16.0 [16.0;17.0]  p <sub>2,3</sub> =0.001	17.0 [17.0;17.0]  p <sub>3,4</sub> =0.157	17.0 [17.0;17.0]  p <sub>1,4</sub> =0.001
Clock Drawing Test Median value, Me [P25;P75], p (Wil.Crit.)	9.0 [9.0;10.0]  p <sub>1,2</sub> =0.287	10.0 [9.0;10.0]  p <sub>2,3</sub> =0.108	10.0 [9.0;10.0]  p <sub>3,4</sub> = 0.108	10.0 [9.0;10.0]  p <sub>1,4</sub> =0.38
Stage 1	5.0 [5.0;6.0]  p <sub>1,2</sub> =0.239	5.5 [5.0;6.0]  p <sub>2,3</sub> =0.83	6.0 [5.0; 6.0]  p <sub>3,4</sub> =0.227	6.0 [5.0;6.0]  p <sub>1,4</sub> =0.043
10 words Memory Task Median value, Me [P <sub>25</sub> ;P <sub>75</sub> ], p (Wil.Crit.)	35.0 [32.0;37.0]  p <sub>1,2</sub> =0.001	36.0 [35.0;38.0]  p <sub>2,3</sub> =0.128	36.0 [35.0;38.0]  p <sub>3,4</sub> =0.227	36.6 [35.0;38.0]  p <sub>1,4</sub> =0.012
Stage 2	5.0 [4.0;6.0]  p <sub>1,2</sub> = 0.486	5.0 [5.0;6.0]  p <sub>2,3</sub> =0.017	5.0 [5.0;6.0]  p <sub>3,4</sub> =0.31	5.5 [5.0;6.0]  p <sub>1,4</sub> =0.06
Stage 3	4.0 [4.0;5.0]  p <sub>1,2</sub> =0.0124	5.0 [4.0;5.0]  p <sub>2,3</sub> =0.423	5.0 [4.0;5.0]  p <sub>3,4</sub> =0.61	5.0 [4.0;5.0]  p <sub>1,4</sub> =0.002
<b>Spontaneous Visual Memorization,</b> Median value, Me [P25;P75], p (Wil.Crit.)	4.0 [4.0;5.0]  p <sub>1,2</sub> =0.0124	5.0 [4.0;5.0]  p <sub>2,3</sub> =0.423	5.0 [4.0;5.0]  p <sub>3,4</sub> =0.61	5.0 [4.0;5.0]  p <sub>1,4</sub> =0.002
<b>Tardy Reproduction,</b> Median value, Me [P25;P75], p (Wil.Crit.)	3.0 [2.0;3.0]  p <sub>1,2</sub> =0.671	3.0 [3.0;4.0]  p <sub>2,3</sub> =0.108	3.0 [3.0;4.0]  p <sub>3,4</sub> =0.067	3.0 [3.0;4.0]  p <sub>1,4</sub> =0.001
<b>Association Test,</b> Median value, Me [P25;P75], p (Wil.Crit.)	17.0 [16.0;17.0]  p <sub>1,2</sub> =0.085	17.0 [16.0;18.0]  p <sub>2,3</sub> =0.173	17.0 [16.0;18.0]  p <sub>3,4</sub> =0.207	17.0 [17.0;18.0]  p <sub>1,4</sub> =0.003
<b>Shulte Tables,</b> Median value, Me [P25;P75], p (Wil.Crit.)	55.5 [49.0;67.0]  p <sub>1,2</sub> =0.001	55.0 [49.0;59.0]  p <sub>2,3</sub> =0.003	54.0 [50.0;58.0]  p <sub>3,4</sub> =0.207	52.5 [49.0;57.0]  p <sub>1,4</sub> =0.003
<b>Counting forward,</b> Median value, Me [P25;P75], p (Wil.Crit.)	5.0 [5.0;6.0] 5.3± 0.88  p <sub>1,2</sub> =0.638	5.0 [5.0;6.0] 5.36±0.69  p <sub>2,3</sub> =0.556	5.0 [5.0;6.0] 5.42±0.81  p <sub>3,4</sub> =0.201	6.0 [5.0;6.0] 5.54±0.81  p <sub>1,4</sub> =0.081
<b>Counting down,</b> Median value, Me [P25;P75], p (Wil.Crit.)	3.0 [3.0;4.0]  p <sub>1,2</sub> =0.37	4.0 [3.0;4.0]  p <sub>2,3</sub> =0.37	4.0 [3.0;4.0]  p <sub>3,4</sub> =0.63	4.0 [3.0;4.0]  p <sub>1,4</sub> =0.02

Note: Distinctions were considered as statistically significant when significance level was  $p < 0.05$ .

results of testing of patients of the main and control groups after surgery we revealed statistically significant differences between the study groups in terms of MMSE ( $p = 0.006$ ), FAB ( $p=0.001$ ), tests for associative thinking ( $p=0.001$ ), memorizing of 10 words with direct reproduction ( $p=0.007$ ), total number of words ( $p=0.001$ ), tardy reproduction ( $p=0.001$ ), visual memorization of 5 words with direct reproduction ( $p=0.024$ ), Shulte tables ( $p=0.001$ ) (the Mann-Whitney criterion), indicating the benefits of using CSPs.

These results remained 12 months later within follow-up observation of the patients: MMSE ( $p=0.001$ ), FAB ( $p=0.001$ ), Shulte tables ( $p=0.001$ ), tests for associative thinking ( $p=0.001$ ), counting forward ( $p=0.036$ ), memorizing of 10 words with direct reproduction ( $p = 0.002$ ), total number of words ( $p=0.001$ ), tardy reproduction ( $p=0.008$ ), visual memorization with direct reproduction ( $p= 0.008$ ), clock drawing test ( $p= 0.047$ ).

The correlation analysis was carried out to assess the interrelation of different signs, including demographic, medical history (CB duration) and clinical signs (the results of neuropsychological testing). It was found out that as age increased, the test results decreased on the MMSE scale ( $r=-0.35$ ;  $p<0.05$ ), on the FAB scale ( $r=-0.41$ ;  $p<0.05$ ), in terms of concentration according to Shulte tables ( $r=-0.36$ ;  $p<0.05$ ), associative thinking ( $r=-0.31$ ;  $p<0.05$ ), serial account of the Mattis Scale ( $r=-0.31$ ;  $p<0.05$ ), direct reproduction in memorization of 10 words ( $p=-0.31$ ;  $p<0.05$ ), total number of words ( $r=-0.36$ ;  $p<0.05$ ), tardy reproduction in memorization of 10 words ( $r=-0.43$ ;  $p<0.05$ ), memorization of 5 words and direct reproduction ( $r=-0.33$ ;  $p<0.05$ ), memorization of 5 words and tardy reproduction ( $r=-0.41$ ;  $p<0.05$ ), clock drawing test ( $r=-0.39$ ;  $p<0.05$ ). The correlation analysis showed that as CB duration increased, the results of testing on Spontaneous Visual Memorization scale ( $r=-0.38$ ;  $p<0.05$ ), direct reproduction in memorization of 10 words ( $r=-0.39$ ;  $p<0.05$ ), memorization of 5 words and direct reproduction ( $r=-0.35$ ;  $p<0.05$ ), and Shulte tables ( $r=-0.33$ ;  $p<0.05$ ) worsened.

No adverse side-effects were revealed in patients who used CSPs after CABG.

effectiveness of high-tech methods of CABG greatly exceeds the frequency of returning patients to work. This represents an acute social problem since most of the patients who suffer from ischemic heart disease and undergo cardiac surgery are people of working-age. POCD occupies a special place among cerebrovascular complications [17,24]. The development of POCD in patients after cardiac surgery may lead to difficulties in rehabilitation, reduction of social activity and the probability of returning to work [3,10,25]. Instead, in clinical practice the necessity of cognitive functions assessment before surgery and in the postoperative period is often underestimated. However, late diagnosis and therapy of cognitive impairment can lead to further progression of cognitive disorders. Our findings demonstrated a high risk of cognitive decline after 12 days after CABG in the control group. In the group with the use of CSPs the results showed the most significant preserve of the preoperative level of cognitive functioning, in spite of a surgery. We even noticed improvement in most tests. 12 months after CABG in the group with the use of CSPs we have managed not only to return the indices of cognitive functions to their original values, but also significantly improve the performance in almost all tests.

A reliable improvement in results of the conducted research suggests that the proposed method provides safety and high performance in cognitive rehabilitation of patients with impairments of the higher brain functions after CABG. A relatively short course of rehabilitation (10 days) corresponded to the length of hospital stay of patients in the cardiac unit. However, even in such a short course we could obtain significant advantage in terms of efficiency of higher cortical functions recovery.

The complex rehabilitation actions concerning presurgical scheduling of a type and volume of intervention, and also targeted cognitive stimulation are necessary for the complete recovery of cognitive functions. A number of important questions remain unanswered in the theory and practice of cognitive rehabilitation. However, in spite of these problematic issues, more and more specialists emphasize cognitive rehabilitation of patients with CHD who need surgical revascularization.

## Conclusion

CABG is the most effective surgical treatment for ischemic heart disease, as it improves the patient's quality of life and increases life expectancy [3,4]. Currently, the clinical

## Conflict of Interest Statement

The authors declare that there is no conflict of interest regarding the publication of this article.



## References

- Shishneva EV. Optimization of cerebral protection via the method of hypoxic preconditioning and xenon anesthesia in cardio-surgical patients. *Patologiya Krovoobrashcheniya i Kardiokirurgiya*. 2010;3:40–5. Russian.
- Bokeriya LA, Golukhova AV, Vanichkin AG. Echocardiographic correlates in the presence of cognitive dysfunction after cardiac surgery. *Creative Cardiology*. 2015;4:13–25. Russian.
- Selnes OA, Gottesman RF, Grega MA, Baumgartner WA, Zeger SL, McKhann GM. Cognitive and neurologic outcomes after coronary-artery bypass surgery. *N Engl J Med*. 2012;366(3):250–7. <https://doi.org/10.1056/NEJMra1100109>
- Foster JK, Albrecht MA, Savage G, Lautenschlager NT, Ellis KA, Maruff P, et al. Lack of reliable evidence for a distinctive  $\epsilon 4$ -related cognitive phenotype that is independent from clinical diagnostic status: findings from the Australian Imaging, Biomarkers and Lifestyle Study. *Brain*. 2013;136(Pt 7):2201–16. <https://doi.org/10.1093/brain/awt127>
- Phillips-Bute B, Mathew JP, Blumenthal JA, Grocott HP, Laszkowitz DT, Jones RH, et al. Association of neurocognitive function and quality of life 1 year after coronary artery bypass graft (CABG) surgery. *Psychosom Med*. 2006;68(3):369–75. <https://doi.org/10.1097/01.psy.0000221272.77984.e2>
- Levin OS. Pathology of white substance in dyscirculatory encephalopathy: diagnostic and therapeutic aspects. *Trudny Patient*. 2011;12:16–24. Russian.
- Eryomina OV, Petrova MM, Prokopenko SV, Mozheyko EYU, Kaskaeva DS, Gavriyuk OA. The effectiveness of the correction of cognitive impairment using computer-based stimulation programs for patients with coronary heart disease after coronary bypass surgery. *J Neurol Sci*. 2015;358(1-2):188–92. <https://doi.org/10.1016/j.jns.2015.08.1535>
- Lund C, Hol P, Lundblad R Fosse E, Sundet K, Tennøe B, et al. Comparison of cerebral embolization during off-pump and on-pump coronary artery bypass surgery. *Ann Thorac Surg*. 2003;76(3):765–70.
- Norkienė I, Samalavičius R, Misiūrienė I, Paulauskienė K, Budrys V, Ivaškevičius J, et al. Incidence and risk factors for early postoperative cognitive decline after coronary artery bypass grafting. *Medicina (Kaunas) [Internet]*. 2010 [cited 2018 Nov 15];46(7):460–4. Available from: [www://medicina.lsmuni.lt/med/1007/1007-04e.pdf](http://www://medicina.lsmuni.lt/med/1007/1007-04e.pdf)
- Mozheyko EY, Prokopenko SV, Petrova MM, Koryagina TD, Kaskaeva DS, Chernykh TV, et al. Correction of post-stroke cognitive impairments using computer programs. *J Neurol Sci*. 2013;325(1-2):148–53. <https://doi.org/10.1016/j.jns.2012.12.024>
- Patel N, Minhas JS, Chung EM. Risk factors associated with cognitive decline after cardiac surgery: a systematic review. *Cardiovasc Psychiatry Neurol*. 2015;2015:370612. <https://doi.org/10.1155/2015/370612>
- Toeg HD, Nathan H, Rubens F, Wozny D, Boodhwani M. Clinical impact of neurocognitive deficits after cardiac surgery. *J Thorac Cardiovasc Surg*. 2013;145(6):1545–9. <https://doi.org/10.1016/j.jtcvs.2013.02.061>
- Newman MF, Mathew JP, Grocott HP, Mackensen GB, Monk T, Welsh-Bohmer KA, et al. Central nervous system injury associated with cardiac surgery. *Lancet*. 2006;368(9536):694–703. [https://doi.org/10.1016/S0140-6736\(06\)69254-4](https://doi.org/10.1016/S0140-6736(06)69254-4)
- Cicerone KD, Langenbahn DM, Braden C, Malec JF, Kalmar K, Fraas M, et al. Evidence-based cognitive rehabilitation: updated review of the literature from 2003 through 2008. *Arch Phys Med Rehabil*. 2011;92(4):519–30. <https://doi.org/10.1016/j.apmr.2010.11.015>
- Gottesman RF, Grega MA, Bailey MM, Pham LD, Zeger SL, Baumgartner WA, et al. Delirium after coronary artery bypass graft surgery and late mortality. *Ann Neurol*. 2010;67(3):338–44. <https://doi.org/10.1002/ana.21899>
- Petrova MM, Prokopenko SV, Eremina OV, Mozheyko EY, Kaskaeva DS. Cognitive function assessment and their correction effectiveness with the use of computer programmes in patients with IHD in late post-operational period after coronary artery bypass graft surgery. *Zabaykalskiy Meditsinskiy Vestnik*. 2015;2:1–7. Russian.
- Zakharov VV, Yakhno NN. Cognitive impairments in at presenile and senile age. Moscow; 2005:1–71. Russian.
- Krenk L, Rasmussen LS, Kehlet H. New insights into the pathophysiology of postoperative cognitive dysfunction. *Acta Anaesthesiol Scand*. 2010;54(8):951–6. <https://doi.org/10.1111/j.1399-6576.2010.02268.x>
- Dubois B, Touchon J, Portet F, Ousset PJ, Vellas B, Michel B. “The 5 words”: a simple and sensitive test for the diagnosis of Alzheimer’s disease. *Presse Med*. 2002;31(36):1696–9.
- Brodsky H, Moore CM. The Clock Drawing Test for dementia of the Alzheimer’s type: A comparison of three scoring methods in a memory disorders clinic. *Int J Geriatr Psychiatry*. 1997;12(6):619–27.
- Bertola L, Mota N, Copelli M, Rivero T, Diniz B, Romano-Silva MA, et al. Graph analysis of verbal fluency test discriminate between patients with Alzheimer’s disease, mild cognitive impairment and normal elderly controls. *Front Aging Neurosci*. 2014;6:185. <https://doi.org/10.3389/fnagi.2014.00185>
- Luria AR. An introduction to neuropsychology. Moscow: Academy; 2002:1-380.
- Otomo S, Maekawa K, Goto T, Baba T, Yoshitake A. Pre-existing cerebral infarcts as a risk factor for delirium after coronary artery bypass graft surgery. *Interact Cardiovasc Thorac Surg*. 2013;17(5):799–804. <https://doi.org/10.1093/icvts/ivt304>

24. Barbarash OL, Kurguzova EM, Ivanov SV, Kazachek JaV, Bajrakova JuV, Avramenko OE, et al. Effectiveness and safety in pre-surgical statin treatment for patients with IHD. *Serdtshe*. 2011;10(6):315–20. Russian.
25. Taggart DP. Contemporary coronary artery bypass grafting. *From Med*. 2014; 8(4):395–8. <https://doi.org/10.1007/s11684-014-0374-7>

# THE PROBLEM OF PATIENTS' ADAPTATION TO FULL REMOVABLE DENTURES

V. Galonsky<sup>1,2</sup>, I. Kostritsky<sup>3</sup>, V. Chernov<sup>1</sup>, A. Gradoboev<sup>4</sup>

<sup>1</sup>Prof. V.F. Voino-Yasenetsky Krasnoyarsk State Medical University, Krasnoyarsk, Russian Federation

<sup>2</sup>Siberian Branch of the Russian Academy of Sciences Krasnoyarsk Scientific Center, Research Institute for Medical Problems of Northern Regions, Krasnoyarsk, Russian Federation

<sup>3</sup>Irkutsk State Medical University, Irkutsk, Russian Federation

<sup>4</sup>Dental Clinic "Helios" LLC, Sharypovo, Russian Federation

## Abstract

One of the key modern orthopaedic dentistry problems related to rehabilitation of patients with complete edentulism is the process of their adaptation to artificial orthopaedic constructions. According to fundamental and modern scientific research, the biological factor, i.e. the complex of all reactions of the organism to the prosthesis including psychological reactions that is individual for each user, is the most important one.

Development of new conditioned-reflex connections and formation of cortical inhibition of active stimulus, that a full removable denture is, depends directly on the balance and dynamics of patient's neural processes despite having several common characteristics including chronometric ones that can be revealed in the majority of patients of this category.

Furthermore, previous experience of full removable denture usage is of great importance, specifically its presence or absence and whether it was positive or negative etc., which in its entirety influences the degree and intensity of phases in patient's adaptation to a new artificial construction.

In this connection, it is important to note the role of patients' psychological preparation, their familiarisation with corresponding illustrative material, establishment of the psychological contact aimed to form positive but at the same time realistic view on the provided prosthetic care in terms of functional and aesthetic optimum restoration, which is an essential part of successful rehabilitation for this category of patients.

On the grounds of many years' practical experience, a number of most frequent complaints and questions of patients provided with rehabilitation using full removable dentures which frequently accompany adaptation process and demand careful doctor's attention while performing explanatory work has been developed. Thereafter, it is necessary to make a corresponding note in patient's medical record with signature confirmation in order to prevent further conflicts associated with the process of adaptation to dentures and its peculiarities related to this specific patient.

## Keywords

*adaptation • full removable dentures • complete edentulism • orthopaedic dental treatment*

## Introduction

Orthopaedic treatment is a serious intervention into the human organism, one of the main problems in which is the patient's effective adaptation to the denture. One of the most widely-used methods of rehabilitation for patients with complete edentulism is full removable denture treatment.

In this sort of prosthetics, success in restoration of functional and aesthetical optimum depends directly on the process of patient's adaptation to the prosthesis. In orthopaedic dentistry, the term "adaptation" (lat. *adaptatio* – fit, adjust is used in the following two situations: 1) meaning the patient's

habituation to the prosthesis, 2) meaning patient's prosthetic impression area tissue adjustment to the denture at rest and during functional load [1, 2].

Therefore, the necessity to understand mechanisms of patient's adaptation to the orthopaedic construction is at the foreground. In particular, these are morphological, physiological and psychological bases exerting immediate influence on the process of adaptation as well as possibilities of their adjustment, correction and creation of most favourable conditions for alleviation of adaptation to removable orthopaedic constructions.

## Materials and Methods

Both modern scientific literature and fundamental works touching such essential aspects as conditioned reflexes and conditions of their formation and inhibition were used as the source of the material presented in the article. Our team's long-term clinical experience in rehabilitation of this category of patients was used to formulate a list of most frequently observed problems and issues in the habituation to full removable dentures by patients

## Results

As the result of modern and fundamental literature analysis, theoretical aspects of patients' adaptation to orthopaedic dental constructions, namely, full removable dentures, have been considered. Priorities of different adaptation factors in the process of adaptation have been denoted. Among those, the psychological factor was found to be the leading one as pivotal to successful rehabilitation. Based upon many years of practical experience, a list of the main difficulties and questions asked by patients within the process of adaptation to full removable dentures has been formed.

## Discussion

Dental prosthetics, especially involving removable orthopaedic constructions, is a serious medical intervention into the human organism that affects it massively. Despite the fact that the denture might be produced in accordance to all rules of prosthodontic art, the main factor of successful prosthesis exploitation and habituation by the patient is a biological one. Biological factor is understood as the integrity of all reactions of the organism to the denture. In turn, reactivity of the patient's organism, oral cavity organs and tissues, mucous coat of the prosthetic impression area in particular and the whole oral region in general, reactivity of bone tissue, muscles and temporomandibular joints depends on health status of a person, his/her age, higher nervous activity type and psychological status [3, 4, 5].

A person's higher nervous activity type and features of their temperament exert substantial influence on processes of adaptation to dentures that must be taken into account in clinical practice by dentists-orthopaedists.

*Melancholic* is the one having weak nervous system type with prevalence of inhibition processes. Such patients are noted to have difficulties in adaptation to dentures. They are sensitive;

the adaptation process to an orthopaedic dental construction may be complicated by lack of stimuli for habituation and expressed suspiciousness leading to excess perception of individual sensations caused by the denture. These patients are prone to trusting their "neighbour" more than a doctor.

*Sanguine* is the one having strong nervous system type with balanced processes of excitation and inhibition. As a rule, such patients cooperate with the dentist-orthopaedist and adhere to the doctor's instructions orderly. Such patients usually adapt to dentures easily and without any complications.

*Phlegmatic* is the one having strong nervous system type with inert processes of excitation and inhibition. Such patients are dilatory, sometimes distrustful but disciplined. They usually endure discomfort associated with adaptation to dentures well. Mood stability intrinsic to them allows quite slow but successfully finish the denture habituation period.

*Choleric* is the one having strong nervous system type with unbalanced processes with prevalence of excitation. The dentist-orthopaedist must be specific in recommendations and instructions as well as uncensorious, polite and patient within the process of communication.

A denture introduced into patient's oral cavity is a strong stimulus for mucous coat and periodontium receptors. Due to the ability of periodontium receptors to adapt to masticating pressure, a substantial part of information from the stimulus does not reach consciousness and therefore does not overstrain higher divisions of central nervous system. This circumstance explains relatively fast habituation of fixed dentures. The quantity of excited receptors and irritation intensity increase during removable denture usage. In response to this, higher mechanisms activate while excitation reaches the sphere of consciousness. Cortical inhibition development velocity and formation of new conditional reflex connections depends on the dynamicity and balance of patient's nervous processes. Subsequent formation of inhibition in response to other identical conditioned stimuli is significantly more rapid and easier than for the first time [6]. At the same time, it is necessary to note that development of conditioned reflexes becomes more difficult with age and their extinction is observed. This fact is associated with weakening of cortical inhibitory influence on subcortex centres [7, 8].

Additionally, correct psychological preparation of patient and his/her understanding of the necessity to use the prosthesis as a treatment means aimed to maintain their health are of large importance for their adaptation to dentures. For that purpose, it is necessary to perform demonstration of illustrative materials before treatment initiation, whether it is a preliminarily produced demonstrational exemplar – a model (which is preferable due to additional tactile perception of the object) or graphic representation of the prosthesis – a drawing, a photograph. This is done in order to not to allow the final material result of the dentist-orthopaedist's work

become a surprise and provoke rejection by its appearances and size and lead to the following characteristic reaction - "how will I bear this in my oral cavity?" In this regard, it is also outstandingly important for the dentist-orthopaedist to inform the patient about peculiarities of full removable dentures during the whole period of orthopaedic treatment, as well as about fundamental difference between natural and artificial teeth and the patient's own role in success of treatment. The patient must know that full removable denture treatment efficacy does not only depend on the quality of the prostheses itself, but, to a certain extent, it also depends on the patient's dedication to habituation to the denture. Thus, it depends on recognition of the patient's difficulties associated with adaptation to full removable dentures, on the patient's willingness and intention to overcome the mentioned difficulties.

An important factor defining general reaction of a person to presence of a removable denture in the oral cavity is their psychological preparedness depending on whether they trust their doctor and on the degree of their awareness about limits in possible restoration of mastication, speech and face appearance. The patient must know that prosthetic devices are only able to restore what was lost due to the absence of teeth and alveolar ridge atrophy, while many age-related changes are almost impossible to revert [9]. Psychological adaptation of patients to full removable dentures is of pivotal importance. This notion is defined as the "integrity of complex conditioned reflex reactions of patient related to the sphere of human emotions and defining the degree of their satisfaction by prostheses". In this connection, quite illustrative are clinical studies revealing strong positive emotions evoked by dental arch restoration, improvement of face appearance and its general rejuvenation associated with successful denture treatment using different removable orthopaedic constructions. Patients' (especially females') aesthetic satisfaction by dentures significantly enhances adaptation to them. And conversely, prejudice and suspiciousness of the patient may exert negative impact on the adaptation process during formation of new or restoration of former conditioned reflexes associated with the complexity of psychic reactions and the patient's attitude.

The psychological background of communication with the patient initially set by the dentist-orthopaedist involving formation of elements of trust, friendship, consideration and understanding in regard to household issues of the patient (such as garden planting, crop harvesting, discussion of problems related to communication with grandchildren, etc.) is the key factor in solving this issue. In the problem of patients' adaptation to full removable dentures, there is an important and still under-investigated aspect of speech adaptation which also lies within the sphere of conditioned-reflex activity dependent not only on functional peculiarities of the tongue, soft palate, masticatory and mimic muscles

but also on optimal interaction of active speech articulation organs with prostheses in general and with their separate components in particular [10, 11].

The above-mentioned data prove the fact that adaptation of patients to full removable dentures is a problem that has not been solved completely in regard to separate theoretical and practical aspects. Nevertheless, a certain contribution to the solution of this issue has been made by Russian scientists who have dealt with problems of local and general adaptation of patients to dentures.

A full removable denture is sensed as a foreign body by tissues and organs of the human oral cavity and is a strong stimulus for nerve endings of the oral cavity mucous coat. Excitation of sensitive receptors in the oral cavity is transmitted via the reflex arc to salivation centres, speech, etc. resulting in excessive salivation and vomiting reflex, impairment of speech, mastication and deglutition functions. Adaptation or adjustment to a removable denture comes slowly and gradually. This process is expressed by development of neuromuscular coordination, restoration of impaired maxillofacial area functions. Sensation of an orthopaedic construction as a foreign body disappears with habituation and full adaptation of the patient. Adaptation to removable prostheses takes from 10 to 30 days and depends on a variety of factors. According to data by V. Yu. Kurlyandsky (1969), patients' adaptation period to a removable prosthesis is affected by the degree of its fixation and stabilisation, presence or absence of pain in the prosthetic impression area, peculiarities in construction of the prosthesis and by other factors. In case of timely denture treatment, adaptation period decreases to 3-5 days. These data have been confirmed by objective data by a number of modern studies [12].

The process of adaptation to a denture could be considered as a manifestation of cortical inhibition. In the beginning, a denture is sensed as a foreign body – an abnormal stimulus. Due to the works of I. P. Pavlov (1923) on conditioned reflexes, sensation of a prosthesis as a foreign body disappearing over time is to be considered as a manifestation of cortical inhibition. In its mechanism, inhibition is of internal or conditioned nature. This inhibition develops in the prosthesis bearer due to the general law, according to which any excitation against the background of its long-term presence and becomes an inhibition agent with essential participation of the cortex. Experiments on animals carried out in I. P. Pavlov's laboratory (1903) revealed and proved that an abnormal stimulus initially evoking active reaction begins evoking less and less active reactions over time and finally loses its effect completely. Against the background of permanent application of such passive stimulus, the conditioned reflex becomes inhibited. This proves that the reaction does not disappear but the phenomenon of inhibition is present. Such inhibition could be removed (interrupted) by effect of a stronger stimulus [13].

From this point of view, a newly applied removable denture is an active stimulus for sensitive nerve endings in the oral cavity and will be such until cortical inhibition is developed.

Excitation of oral cavity receptors by a denture is manifested by excess salivation, articulation impairment, retching. In case of hyperexcitability, continuous retching is observed. In specific cases, immediate emergence of vomiting reaction is registered. Adaptation mechanism as expression of compensatory brain hemispheres activity reveals itself in gradual restoration of motor action in dentofacial innervation. For example, acts of food biting, mastication and deglutition are non-coordinated in the beginning of prosthesis exploitation thus requiring more physical and emotional-volitional strength for their performance. After some time of denture usage, these acts are being performed in a coordinated and reflexive manner, which is explained by the following change of excitation to inhibition in the brain cortex. Emergence of coordinated and coherent activity of all organs participating in food processing in the mouth in presence of dentures is the result of coordinating role of the nervous system. It is exactly the nervous system that is capable of rebuilding functions and forming new interrelations. Disengagement of the coordinating role of the central nervous system in denture users has been proved by widely known facts of denture aspiration during sleep time [14].

Cortical inhibition begins in different periods from the first day of denture usage and depends on a number of factors, the main among which is the type of higher nervous activity. Period of adaptation to dentures depend on its size and construction, the degree of its jaw fixation and the character of masticatory pressure through the mucous coat and periodontium. Large influence on denture adaptation period is exerted by emerging pain from prosthesis pressure (sharp sides of the jaws, sores, ulcers on prosthetic impression area tissues and proximate zones). In case of sharp edges on jaws or sore formation, adaptation period extended. This follows from the fact that in such cases the prosthesis produces growing irritating effect which prevents formation of inhibition in the central nervous system and the prosthesis is still sensed as a foreign body. Inhibition will appear only after removal of all additional stimuli.

V. Yu. Kurlyandsky outlines three successive phases of adaptation to dentures. The first phase of irritation is observed on the first day of full removable denture delivery to the patient. This phase is characterised by the patient's attention being fixed on the orthopaedic construction as on a foreign body. The irritation is expressed in form of excess salivation, drastic changes in articulation and phonation, lisping, inadequate deglutition efficiency, tension in lips and cheeks, vomiting reflex appearance. The second phase is partial inhibition that comes within the period from the first to the fifth day after initial prosthesis application. Characteristic features of this phase are gradual normalisation of salivation, restoration

of articulation and phonation, disappearance of tension in soft tissue, inhibition of vomiting reflex (if initially present), beginning of chewing efficiency restoration (the rapidity of the processes may be higher or lower depending on the prosthesis construction and initial clinical status of toothless alveolar ridges, the degree and type of their atrophy). The third phase is full inhibition that comes within the period between the fifth and the thirty-third day after prosthesis application. A characteristic feature of this period is the fact that the denture bearer does not feel the prosthesis as a foreign body but instead cannot dispense without it. Full adjustment of the muscular and joint system to restored (or altered) occlusion is observed. Deglutition efficiency is restored to the maximum possible value.

Inhibition developed in response to full removable denture usage is revertible, i.e. in certain conditions an inhibited stimulus becomes active again. Some inhibition weakening is observed in prosthesis bearers that remove dentures from the oral cavity during night time. They always note that they need some time in the morning for articulation to be restored and for prosthesis in the mouth not to be felt, i.e. the orthopaedic construction is an abnormal stimulus again in the beginning. However, stimulus action of the prosthesis is quite short-term in this case. This is explained by the fact that a once-developed inhibition facilitates development of repeated inhibition as a once-formed reflex promotes formation of conditioned reflexes. This is a typical reaction of living beings to a stimulus over one or another period of time after a pause in its action. At the same time, this fact points to the after-impression persisting in the central nervous system for certain time after action of the stimulus that is the pivotal factor defining the character of future responses to action of new stimuli. Residual effects of the action participate in defining the background and functional mobility of reacting substrates. The presence of after-impression explains the fact that patients undergoing repeated prosthetic care experience more rapid adaptation processes (even if the patient has not used a denture for an extended period of time) and therefore cortical inhibition in response to action of the irritation by a newly produced denture. It is also known that the best orthopaedic treatment results and most rapid adaptation to prosthesis is observed in case of immediate prosthetics, especially in cases when bases of prostheses are produced from flexible plastic as well as in cases of full removable dentures lying on dental roots through a telescopic system or button fixators of cast inlays which is explained by a significant role of teeth periodontium proprioception.

Recently, clinical practitioners have begun devoting increasing attention to the problem of psychogenic intolerance to removable dentures as the number of patients with maladaptation to these orthopaedic constructions has grown. Results of a number of psychoanalytical studies have shown



that such patients have significant differences from those in the control group residing in the fact that they stated more frequent complaint about internal organ dysfunctions. All attention of such patients, as a rule, is so concentrated on their sickliness that it is complicated to discern between real, actual symptoms and spurious ones (false symptoms speculated by the patient). Individuals with unbalanced psyche are especially frequently registered among patients with temporomandibular joint disorder (TMJD). It is suitable for a dentist-orthopaedist to cooperate with psychologists or in some cases with psychiatrists while treating patients of this category.

Efficacy of full removable denture treatment does not only depend on the art of medicine and dental mastery but is also largely contributed to by preliminary psychological preparation of the patient to difficulties in adaptation to the prosthetic construction intrinsic to this sort of dental treatment. Advance notice and acquaintance of the patients with future inconveniences after production of removable orthopaedic constructions and due medical care of patients in this complicated life period of adaptation predefine the success of the final result of orthopaedic dental treatment measures. Drawing upon personal, many-year experience in prosthetic care provided to such category of patients, we have revealed a number of main issues to be warned about in advance for the patients who will begin using full removable dentures [15, 16, 17].

Introduction of this list to the patient with confirmation signature in the medical record followed by receiving a leaflet guide with information about inconveniences a patient might experience after production of full removable dentures are of great importance to the dental clinic and the dentist-orthopaedist. In this connection, we are presenting a text variant of a leaflet guide for a patient who starts using full removable dentures with a list of temporary inconveniences he/she is sure to face with after orthopaedic treatment and application of prostheses that are transient in the period of adaptation to full removable dentures.

1. *Nausea and retching.* These symptoms are more pronounced in case of full removable denture treatment of the upper jaw. These phenomena can be terminated or alleviated by shortening of the distant (back) palatal base part. Therewith, it is necessary to keep in mind the fact that this manipulation may disrupt the border seal in clinical cases of full removable maxillary denture treatment, which will impair its fixative ability. Respiratory exercise – deep inhalations and exhalations through the nose – at initial stages of denture usage makes it possible to reduce such phenomena. It possible to apply topical anaesthesia to the “A” zone (the rear palatal border of the prosthesis) as a temporary adaptative manipulation at the first stage of prosthesis exploitation.

2. *Excess salivation.* It is observed at the beginning of removable denture usage. This phenomenon is explained

by the fact that any foreign body in the oral cavity inducts reflexive salivation increase. This inconvenience is eliminated through prolongation of continuous removable denture usage period, patient’s adaptation (habituation) to it and inhibition of irritating influence of the orthopaedic construction stimulating the above-mentioned reflex.

3. *Biting of cheeks along the teeth occlusion line.* It is possible in the beginning of use of removable dentures or dentures replacing the lacking lateral group of teeth. This circumstance is explained by masticatory muscle atrophy during the period of teeth absence and reduction in the height of the lower third of the face. This inconvenience is liquidated after adaptation of masticatory muscles to new functioning conditions in presence of removable artificial orthopaedic constructions with the condition of cheek depression removal and restoration of optimum height of the lower third of the face.

4. *Subjective sensation of the upper lip being pushed out and protrusion of the upper teeth group from under it.* This circumstance is explained by orbicular muscle atrophy during the period of frontal teeth group absence and decrease in height of the lower third of the face. This inconvenience is terminated after adaptation of the orbicular muscle to new functioning conditions through termination of adoral soft tissue depression and restoration of optimum height of the lower third of the face.

5. *Speech defect.* It is possible in the beginning of removable denture usage, especially a maxillary one replacing the frontal group of teeth. This circumstance is explained by presence of new articulatory interrelations of the tongue tip with the frontal group of artificial teeth and decrease of functional space for the tongue. Speech is restored after adaptation of the tongue to new articulatory interrelations. Elimination of lisping and defects in pronunciation of particular sounds – the “s” sound, more frequently – is possible through gradual shortening of the frontal teeth cutting edge in dynamics in order to form the optimum sound pronunciation.

6. *Subjective sensation of insufficiency (lack) of space for the tongue in the oral cavity.* It is possible in the beginning of removable denture usage, especially in cases of simultaneous production of both maxillary and mandibular dentures. In case of teeth absence, the space for the tongue was only anatomically restricted by soft tissues resulting in its compensatory hypertrophy due to participation in mastication while the denture base and artificial teeth arches decrease available space for it. This inconvenience is less pronounced in case of clasp prostheses or dentures with metallic base in comparison with laminar prosthesis made of acrylic plastic due to the reduced thickness of the metallic base approximately equal to 0.3-2.5mm. This inconvenience is terminated after adaptation of the tongue to new (“constricted”) conditions of functioning that cannot be avoided.

7. *Painful sensations in the mucous coat of the impression area – prosthetic stomatitis in the beginning of removable denture usage.* Such condition is explained by the mucous coat of the prosthetic impression area being exposed to abnormal mastication load. Prosthetic stomatitis is more expressed in patients using removable dentures for the first time and may be almost absent in case of repeated prosthetic treatment due to characteristic morphological changes of the mucous coat of the prosthetic impression area – thickening and hardening of the epithelial layer. Prosthetic stomatitis is more pronounced in patients with exostoses, irregularities and eminences of the alveolar ridge caused by heterogeneous atrophy and recent removal of teeth as well as in case of periodontium diseases characterised by rapid heterogeneous alveolar bone atrophy, rapidly progressive pathologic tooth mobility and their subsequent loss in medical history. This inconvenience is terminated by means of dynamic denture base correction and preliminary bone prominence isolation on gypsum model of the jaw.

8. *Ingression of food debris under the denture base.* This inconvenience is caused by construction features of removable dentures and a specific character of their interrelations with prosthetic impression area tissues. The above inconvenience is permanent and inevitable for the patient and requires psychological preparation for the necessity to follow personal oral cavity hygiene rules (washing of the denture and oral cavity rinsing after every meal). To some extent, this inconvenience could be negated through application of denture adhesives.

9. *Balance and displacement of denture during masticatory load.* This inconvenience is caused by compressibility and mobility of the mucous coat of the denture impression area and is defined by peculiarities of individual morphological structure of this anatomical structure as well as its damping properties. To some degree, this effect may be negated or compensated via usage of super elastic prosthesis materials.

10. *Lower masticatory efficiency of removable dentures in comparison with dental bridges based on natural teeth and dental implants as well as with intact dentition.* This inconvenience is caused by the fact that the mucous coat is not anatomically and physiologically conditioned for perception of masticatory load while constructive features of removable dentures provide for concentration of the main part of masticatory load on it. This requires larger emotional-volitional effort and more time for food mastication. This inconvenience is more pronounced in patients who use removable dentures for the first time and it is less expressed during subsequent (repeated) removable denture treatment resulting from hardening of the epithelial layer of the mucous coat of the prosthetic impression area with the increase of the denture bearing time period.

11. *Peculiarities in teeth setup of full removable dentures that do not comply with anatomical features of the patient's dental occlusion before loss of teeth.* This inconvenience is caused by individual features of alveolar ridge and jaw bone atrophy requiring arrangement of artificial teeth in the middle of the alveolar ridge with full removable denture treatment which provides for most effective fixation and stabilisation of the prosthesis during functional load. In certain cases, this inconvenience may be negated through individualised (according to the patient's request) teeth arrangement maximally similar to the lost anatomical norm breaking the rules of artificial teeth arrangement in full removable dentures. This, however, most frequently promotes decline in fixation and stabilisation of full removable dentures.

12. *Worse fixation and stabilisation of mandibular full removable dentures in comparison to maxillary ones.* The prosthetic impression area of the edentulous lower jaw has smaller area. At its border, it has fibre bands of the transitory fold mucous coat moving actively and passively that change their position during functional loads. The lower jaw and the tongue are mobile anatomical structures that are in constant movement. This inconvenience may be decreased through formation of borders of the full removable mandibular denture using functional trials and, to some extent, usage of adhesives for removable denture fixation.

13. *Possible worse fixation and stabilisation of full removable dentures in some patients in comparison to other ones.* Such condition is explained by individual anatomical features of the prosthetic impression area, the degree and the character of alveolar ridge and jaw bones atrophy. This inconvenience may be eliminated to some extent via usage of adhesives for denture fixation.

14. *Short-term phenomena and symptoms of adaptation to removable dentures in the morning in case of ejection of the denture.* This phenomenon is caused by short-term absence of the stimulus. Therefore, its reappearance begins cortical inhibition that rapidly terminates signs of influence of the stimulus in case of constant denture bearing. In order to decrease this phenomenon, it is recommended to perform logopaedic exercises (active speech load) after introduction of the prosthesis into the oral cavity in the morning for acceleration of the inhibition process.

15. *Possible occasional crashes of the denture base made of acrylic plastic.* This issue is defined by the denture material (acrylic plastic) fatigue caused by dynamic multidirectional masticatory loads in aggressive environment of the oral cavity. The quantity of crashes can be decreased through reinforcement of the denture base or avoided via production of prostheses with metal bases.

16. *Inevitable attrition of artificial teeth of removable denture through time.* This issue may lead to decrease in occlusion height, development of angular stomatitis and TMJD. Dynamic

dispensary observation of patients and timely production of new dentures are recommended for prevention of the above-mentioned complication.

17. *Possible absorption of microorganisms and food debris by denture bases.* It is caused by imperfection of acrylic plastic as a prosthesis material. A secondary pathology (oral candidiasis) might form in denture-supporting tissue in nearest and later periods of denture usage. In this connection, application of special denture cleaning means is required as well as ultrasound denture cleaning and recurrent production of new dentures.

18. *Deterioration of full removable denture fixation and stabilisation with every subsequent denture treatment.* It is caused by progressing alveolar ridge and jaw body atrophy and decline in anatomic-topographical conditions for production of orthopaedic constructions.

19. *Full removable maxillary dentures made of acrylic plastic have palate thermal insulation properties.* Thermal sensitivity during food intake is impaired, esophageal burns are possible as well as the “greenhouse effect” with subsequent development of oral candidiasis. This inconvenience can be eliminated through usage of removable prostheses with the metallic base.

art of medicine and dental mastery but it is also largely contributed to by the dentist-orthopaedist’s competence in qualified psychological preparation of a patient for quite complicated future orthopaedic treatment, abilities and practical skills of the specialist, personalised approach to stepwise guidance of a patient at complex and ambiguous adaptation stages of removable orthopaedic construction habituation.

The suggested algorithm of patient instruction regarding possible inconveniences they will inevitably face with after production of full removable dentures as well as its informational content are an effective tool for achievement of final useful effect of orthopaedic treatment for completely edentulous patients using removable orthopaedic constructions.

Availability of the list of difficulties on the path of adaptation to full removable dentures formed on the basis of practical experience makes it possible for a practicing dentist-orthopaedist act confidently at the patient psychological preparation stage and the leaflet guide issued to the patient who puts the confirmation signature in dental out-patient record is an effective law tool for prevention of conflict situations in a dental hospital.

## Conclusion

Therefore, clinical success and functional efficacy of full removable denture treatment does not only depend on the

## Conflict of Interest Statement

It is claimed that no conflict of interest is present for the authors within the framework of this paper.

## References

1. Vecherkina ZhV, Popova TA, Abdulkader ZU, Fomina KA. Analysis of factors affecting the period of adaptation of patients to removable dentures. *System Analysis and Management in Biomedical Systems*. 2016;15(1):80–3. Russian.
2. Tsybina VV, Golubeva LN, Plotnikova IE, Golubev NA. Problems of adaptation to removable dentures and ways of their solution. *Medical-biological and pedagogical basis of adaptation of sports activity and a healthy life style: collection of scientific works of the 4th All-Russian correspondence scientific-practical conference with international participation (April, 29 2015)*. Voronezh: Publishing house “Scientific book”; 2015:173–8. Russian.
3. Maisuradze RT, Ryabova IF, Ganin AS, Merkul'tseva VM. Aspects in psychological condition and clinical research of adaptation processes. *Modern Trends in the Development of Science and Technology*. 2016;11(5):67–71. Russian.
4. Tacenko EG, Lapina NV, Skorikova LA. Predicting adaptation of patients to removable dental structures. *International Journal of Applied and Fundamental Research*. 2014;2-1:182–8. Russian.
5. Maletin A. Influence of gender, age and number of prostheses to the adaptation to a complete denture. *Healthmed*. 2012;6(4):1405–8.
6. Maloletkova AA, Shemonaev VI. Chronophysiological basis of patients adaptation to removable dentures. *Modern High Technologies*. 2012;7:9–11. Russian.
7. Ershov KA, Sevbitov AV, Shakaryants AA, Dorofeev AE. Evaluation of elderly patients adaptation to removable dentures. *Young Science (Eruditio Juvenium)*. 2017;5(4):469–76. Russian.
8. Oreshaka OV. Optimization of the process of adaptation to removable laminar dentures in elderly patients. *Bulletin of Medical Science*. 2017;2(6):57–60. Russian.

9. Iordanishvili AK, Tsygan VN, Volodin AI, Muzikin MI, Lobeiko VV. Psychological adaptation of adults at loss of teeth and elimination of defects of dentitions with use of various designs of dentures. *Bulletin of the Russian Military Medical Academy*. 2017;2(58):49–53. Russian.
10. Badel T, Laškarin M, Carek V, Lajnert V. Speech in patients with removable dental prosthesis. *Medicina*. 2008;44(3–4):241–7.
11. Bizyaev AA, Konnov VV, Lepilin AV, Maslennikov DN, Bizyaeva ND. Modern methods of monitoring of phonetic adaptation of patients to orthopedic constructions of dentures. *Saratov Journal of Medical Scientific Research*. 2011;7(2):474–7. Russian.
12. Redinov IS, Metelitsa SI, Shevkunova NA, Mironov AN, Nikulin AV. The importance of the reactions of adaptation and adjustment of the organs of the oral cavity and free space for the tongue in treating patients with complete loss of teeth. *Fundamental Research*. 2013;(7–1):165–9. Russian.
13. Pavlov IP. Twenty years of experience in the objective study of the higher nervous activity (behavior) of animals. Moscow: Nauka Science Publishing House; 1973. 659 p. Russian.
14. Diasamidze ED. Influence of post-extraction complications on adapting to dentures. *Modern Medicine: Topical Issues*. 2014;27:52–62.
15. Galonsky VG, Radkevich A, inventors. The method of determining adaptation to prosthetic dental structures: Russia patent 2,354,330. 2009 May 10. IPC A61C 13/00. Appl. No 2007147257/14 ; 2007 December 18.
16. Ivanyakov AA, Faizov AR, Solomatin DS, Borisova EG, Poleyeva LP. Use low-energy narrow-band modulated laser radiation for optimize adaptation to removable dentures. *International Bulletin of Student Medicine*. 2018;4(1):165–7. Russian.
17. Iordanishvili AK, Kuvshinova AK, Volodin AI, Grebnev GA, Veretenko EA. Optimization of patient adaptation to removable dentures. *Military Medical Journal*. 2018;339(10):63–5. Russian.

# SPONTANEOUSLY RESOLVED VENTRICULAR FIBRILLATION AND VENTRICULAR TACHYCARDIA IN ARRHYTHMIC VARIANT OF ACUTE MYOCARDIAL INFARCTION (CLINICAL CASE)

E. Skorodumova<sup>1</sup>, V. Kostenko<sup>1</sup>, E. Skorodumova<sup>1</sup>, Y. Shulenina<sup>1</sup>, K. Shulenin<sup>2</sup>, A. Siverina<sup>1</sup>, A. Rysev<sup>1</sup>, M. Solovev<sup>2</sup>, N. Gayvoronskiy<sup>3</sup>

<sup>1</sup>St. Petersburg I.I. Djanelidze Research Institute of Emergency Medicine, St-Petersburg, Russia

<sup>2</sup>Military Medical Academy n.a. S.M. Kirov, St-Petersburg, Russia

<sup>3</sup>3rd Central Military Clinical Hospital n.a. A.A. Vishnevsky, Krasnoznamensk, Russia

## Abstract

Different heart rhythm disorders occur in almost all patients with myocardial infarction (MI). Arrhythmias in setting of MI are caused by electrical instability of myocardium as a result of metabolic and microcirculatory disorders. However, the presence of even severe heart rhythms disorders does not provide a basis for diagnosis of arrhythmic MI. In arrhythmic variant of infarction heart rhythm disorders and associated symptoms should prevail in clinical presentation. Supra ventricular or ventricular paroxysmal tachycardia, less often atrial fibrillation or flutter, and high degree AV block are registered most commonly. Pain may be absent or slight. Loss of consciousness is possible, due to cerebral blood circulation disorder. Arrhythmic variant may be accompanied by acute heart failure or significant arterial hypotension, up to arrhythmogenic shock. This variant of MI often occurs in older people who have anamnesis of structural heart diseases. In MI patients, reduction of cerebral blood circulation due to tachyarrhythmia and hypotension can cause ischemic stroke.

## Keywords

arrhythmias • sudden cardiac death • precordial shock • reperfusion • spontaneous thrombolysis

## Introduction

Generally, arrhythmic variant of MI proceeds as paroxysmal supraventricular tachycardia, episodes of ventricular fibrillation, atrial fibrillation, high-grade atrioventricular block. Pain may not be presented after resolving of heart rhythm disorders. But arrhythmogenic cardiogenic shock often occurs and mortality is high. The arrhythmic variant of MI can lead to significant deterioration of the brain circulation. Neurological symptoms are often considered as a cerebral variant of MI. But in reported case cerebral symptoms should be regarded as manifestations of the arrhythmic variant of MI.

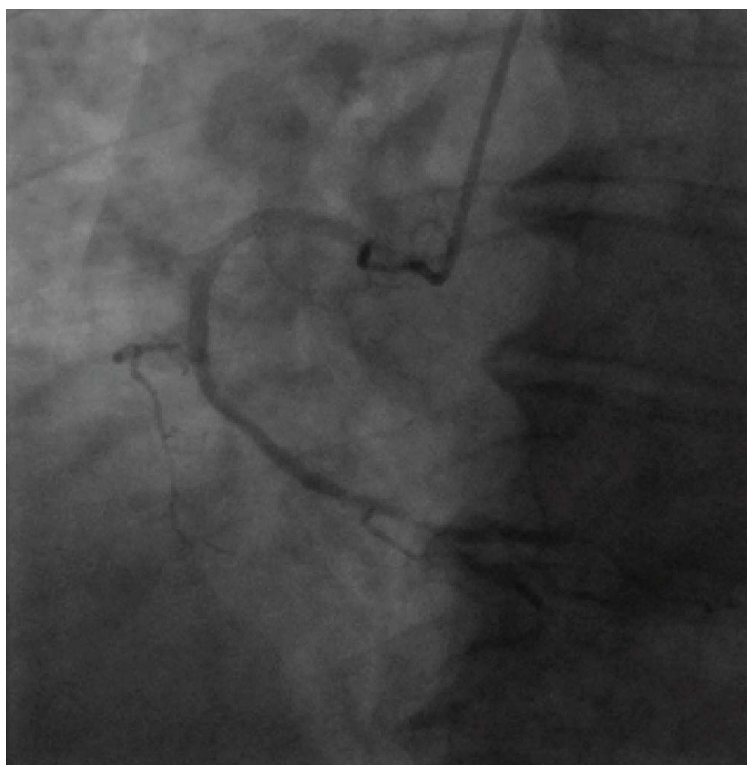
## Case report

The patient M., 60 years old, male, was admitted to the I.I. Djanelidze Institute of Emergency medicine with

complaints for acutely developed syncope. Day before hospitalization the patient lost consciousness, duration of the episode was 5 minutes, relatives called ambulance, the patient was hospitalized to the Institute. At admission the patient didn't have any complains. ECG showed sinus rhythm, negative T-waves in inferior LV wall. Laboratory tests: hemoglobin - 175 g / l, erythrocytes -  $5.0 \times 10^{12}$  / l, leukocytes -  $10.2 \times 10^9$  / l, creatine phosphokinase - 295 units / l, aspartate aminotransferase - 69 units / l, alanine aminotransferase - 47 units / l, troponin T - 0, 11 ng / ml. De Ritis coefficient was 1.46, Grace scale's Risk - 99 points (low risk, probability of death in hospital less than 1%). The patient was diagnosed inferior NSTEMI. Therapy was prescribed according to the appropriate guid-lines. Coronary angiography was performed, stenosis in the distal part of right coronary artery (RCA) was detected (Figure 1). Then this artery was stented.

To identify possible rhythm disturbances and conduction disorders, daily ECG was performed. On 14-th day, it revealed 8 single supraventricular extrasystoles, 1 paired supraventricular extrasystole, at night; 66 single ventricular polymorphic extrasystoles, single late ventricular extrasystoles - 6 in the afternoon and 2 at night. Sino-atrial block with R-R 2476 ms at night. During physical exertion life-threatening heart rhythm disturbances occurred sequentially under appearance of significant ST segment depression (Figure 2), followed by VT «pirouette» type (Figure 4), which passed into VF (Figure 5) replaced by asystole which lasted 3304 ms (Figure 6). Then there was a short recurrent VT transformed to atrial fibrillation (AFib) with ST segment elevation (Figure 7), then recurrent asystole 40 seconds. After that ventricular extrasystole was recorded, followed by a asystole lasted 5554 ms (Figure 8). Then, a single sinus complex paroxysm of AFib with ST segment elevation (Figure 9), several times interrupted by episodes of unstable VT (Figure 10). After that, an episode of slipping ventricular complexes was recorded on the background of the 3-degree AV block, and after a pause which lasted 6328 ms arose a single sinus complex followed by ventricular extrasystole and a pause 3750 ms (Figure 11). Then there was an unstable sinus rhythm, followed by VT 153 beats per minute, after which slipping ventricular contractions were again registered

with atrioventricular block grade 3 with pause which lasted 6328 ms, then sinus contraction and unstable VT 153 bpm, subsequent pause 3437 msec due to subtotal AB block 2nd degree (Figure 12) and episode of AV block 2nd degree with 3: 1 conduction and heart rate 26 per minute, during which there were high T-waves (Figure 13). Then - a short episode of AV block with pause 4429 ms (Figure 14, again VT with VR 99 beats/min (Figure 15), which was replaced by sinus rhythm with intraventricular block and transient complete LBBB (Figure 16). High-amplitude T waves changed to deep ST segment depression. Then normal intraventricular conduction restored, but ST-segment depression and T waves inversion persisted (Figure 17). Total time of cardiac arrest was 3 minutes and 20 seconds. The patient fell down and beated the chest on the steps. Medical staff found the patient in consciousness, without any neurological deficiency and delivered the patient to the CCU. The patient had no any complaints. Laboratory tests immediately after event : hemoglobin - 135 g / l, erythrocytes -  $4.46 \times 10^{12}$  / l, leukocytes  $6.5 \times 10^9$  / l, creatine phosphokinase 205 units / l, aspartate aminotransferase - 52 units / l, alanine aminotransferase - 60 units / l, troponin 0.18 ng / ml. De Ritis coefficient is 0.86. Grace scale - 147 points (high risk, probability of death in the hospital - more than 3%). The patient was underwent coronary angiography revealed stent restenosis and re-stenting of the



**Figure 1.** Stenosis in the distal RCA



distal RCA “stent in stent” has been undertaken. On 15-th day after event the patient was discharged to home with final diagnosis “ Recurrent inferior NSTEMI” rhythm disorders did not occurred till discharge.

Along with conservative therapy, the patient was recommended to install an implantable cardioverter-defibrillator. His follow-up is unknown.

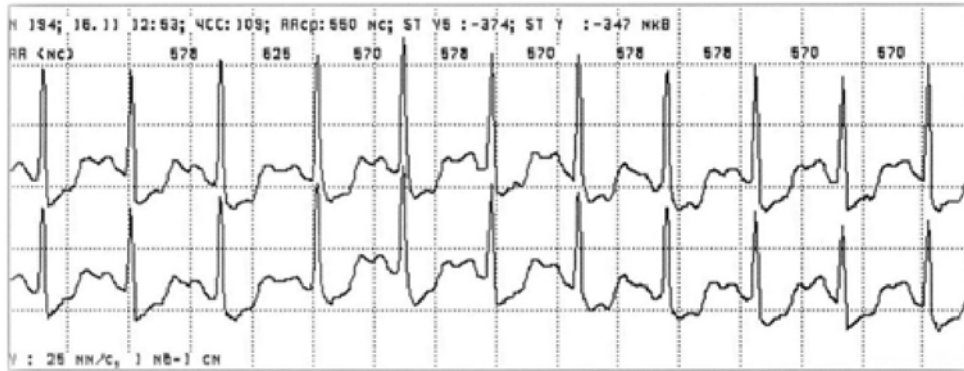


Figure 2. Severe depression of ST segment.

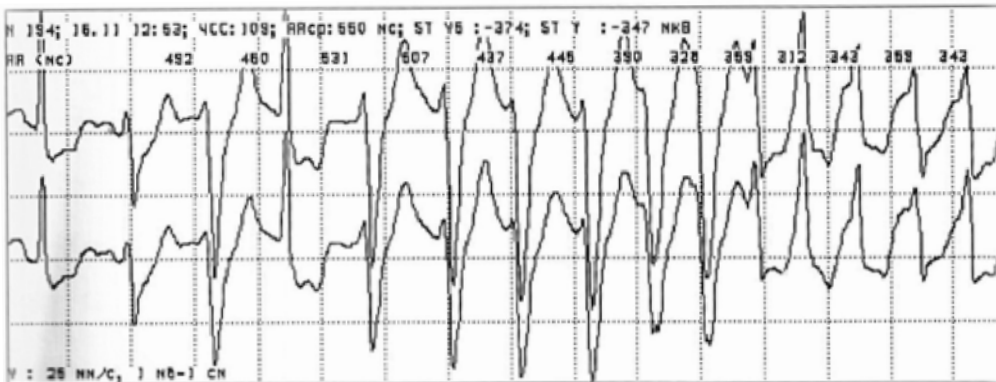


Figure 3. Paroxysm of ventricular tachycardia.

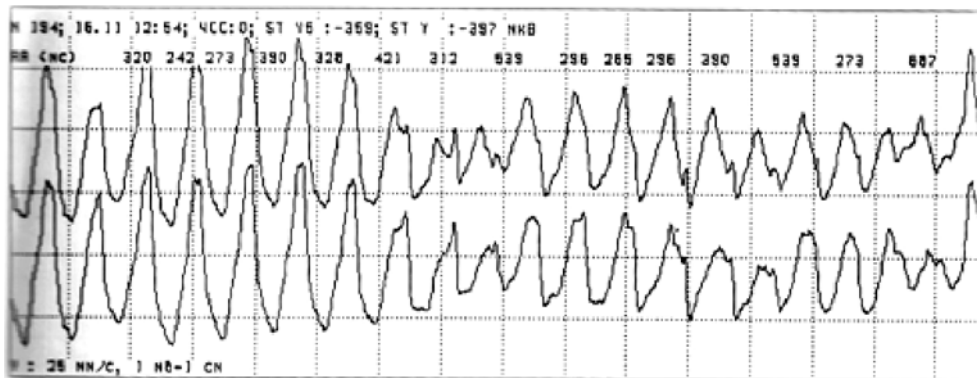


Figure 4. Ventricular tachycardia “Torsades de Pointes”.

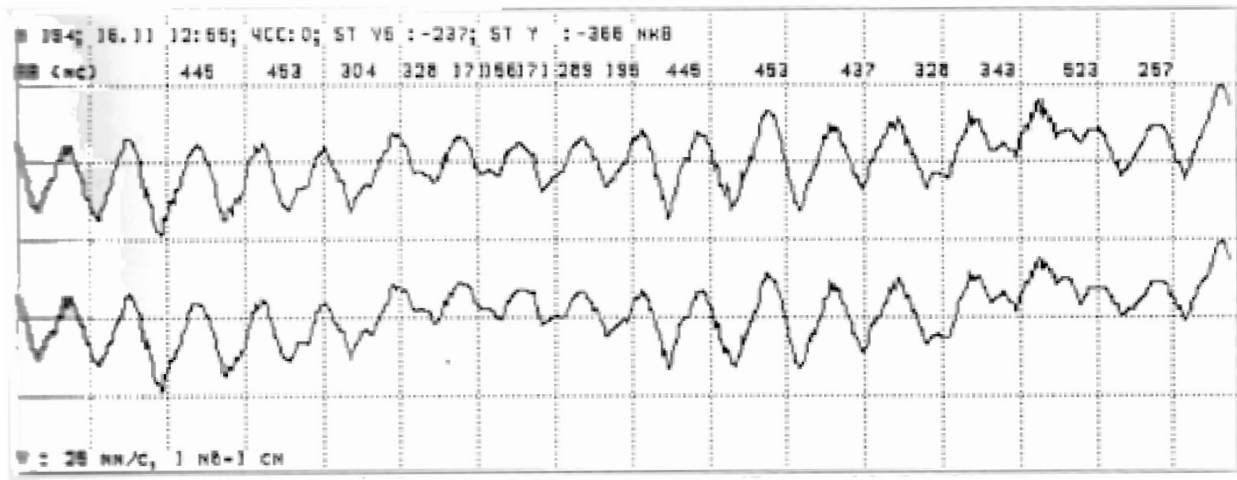


Figure 5. Ventricular fibrillation.

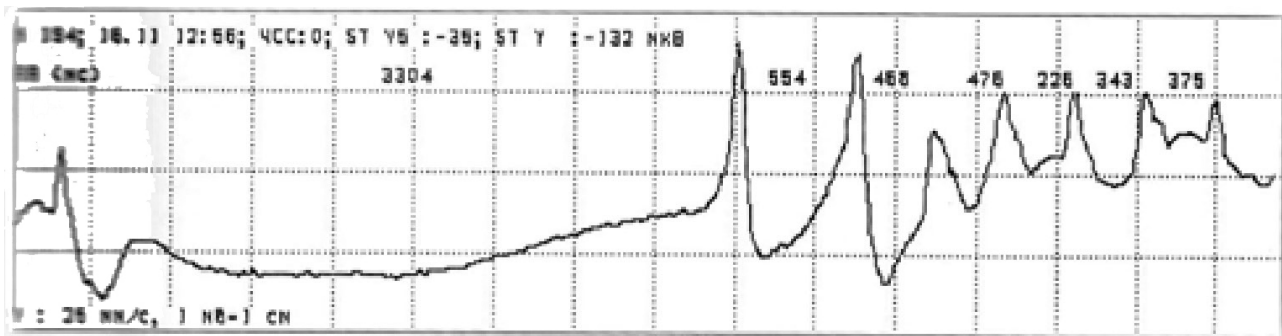


Figure 6. The episode of asystole 3304 ms

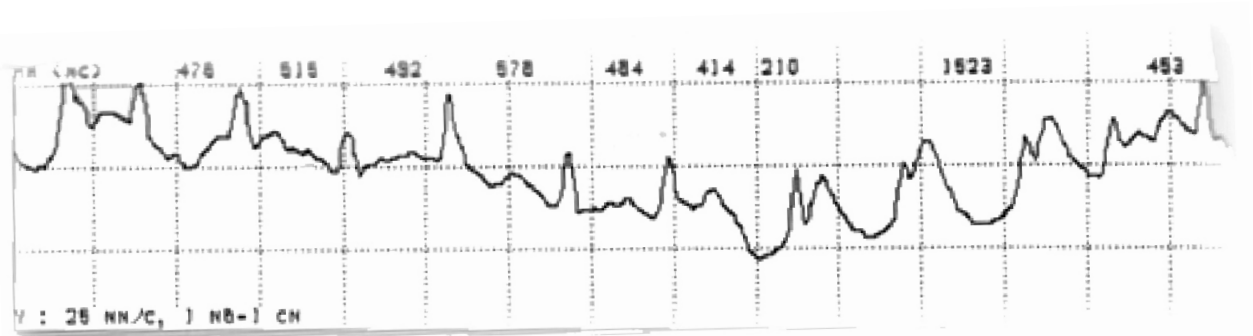


Figure 7. Ventricular tachycardia and atrial fibrillation with ST elevation

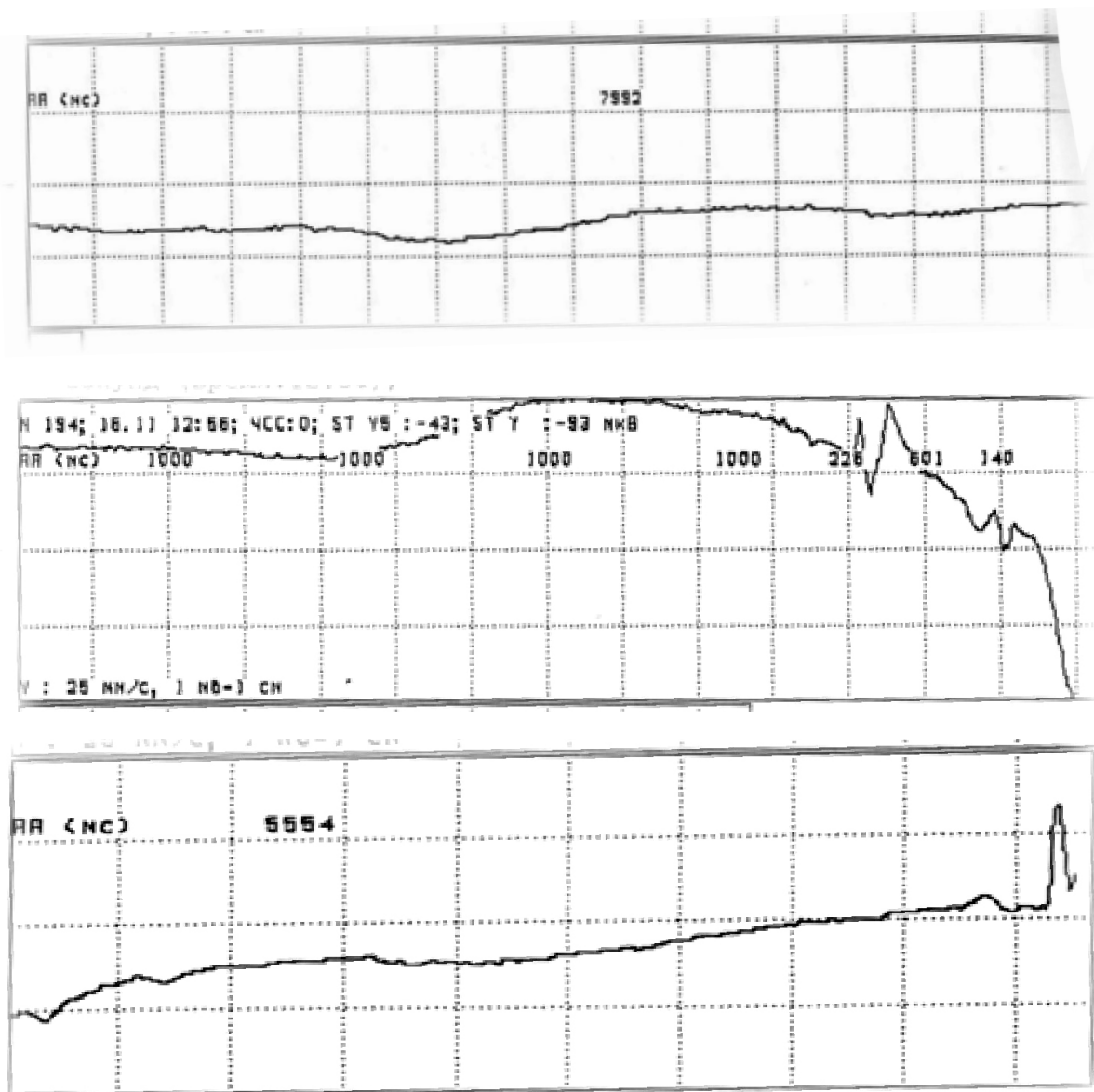


Figure 8. Episode of asystole with single slipping contractions and appearance of a single sinus complex

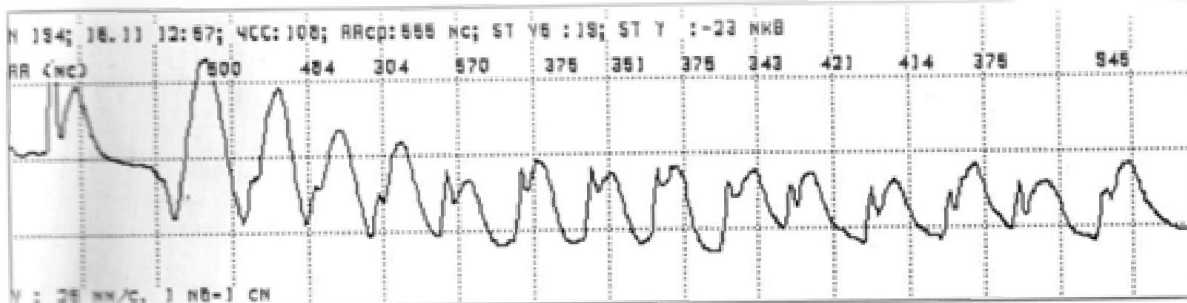


Figure 9. Paroxysm of atrial fibrillation with ST elevation

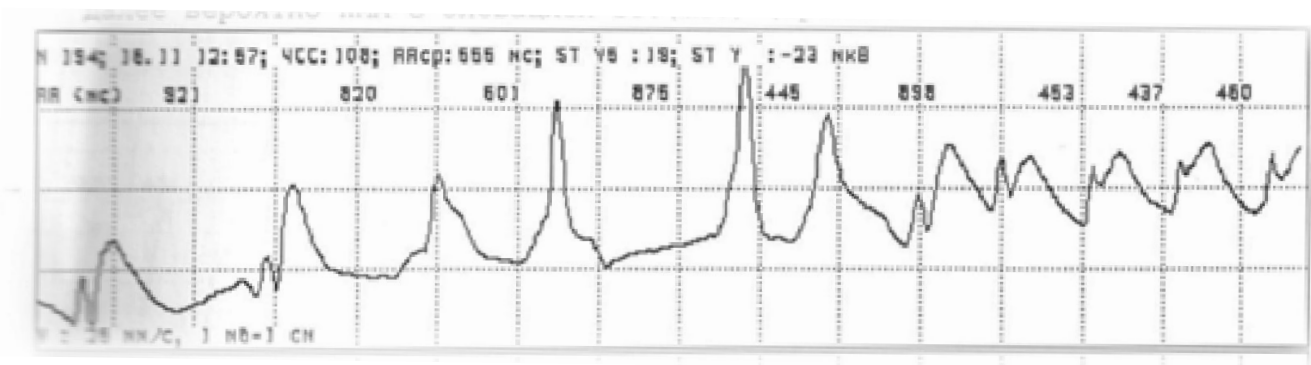


Figure 10. Episodes of unstable ventricular tachycardia

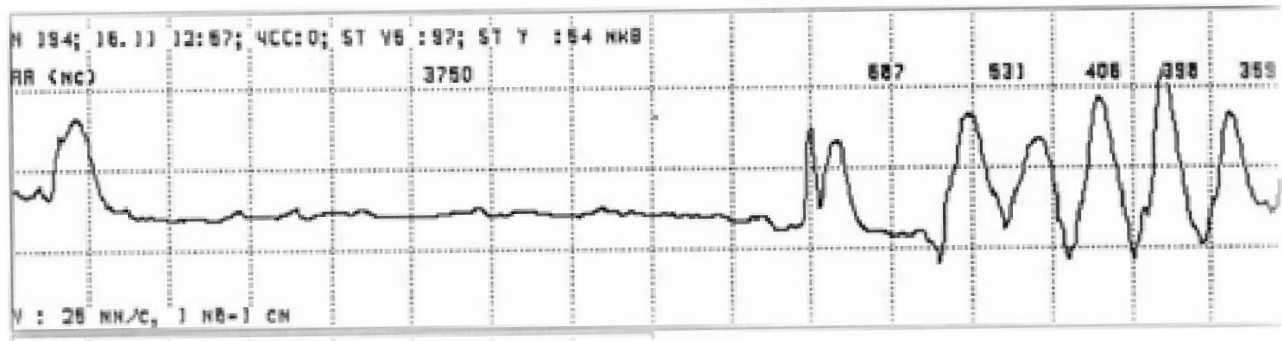


Figure 11. Episode slipping ventricular contractions AV-block III, and after pause 6328 ms there was a single sinus complex, accompanied by ventricular extrasystole and a pause 3750 ms

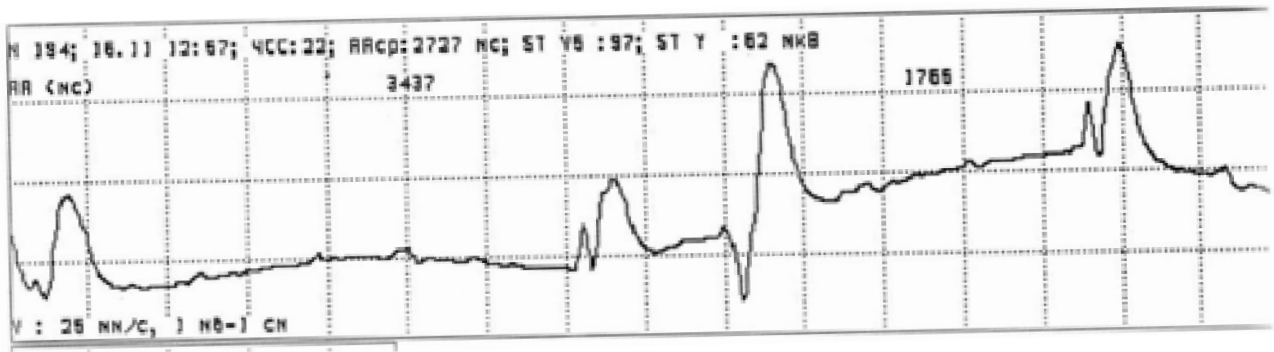


Figure 12. A pause 3437 ms on the background of a 2-degree AV block with single sinus complexes and subsequent single ventricular extrasystole



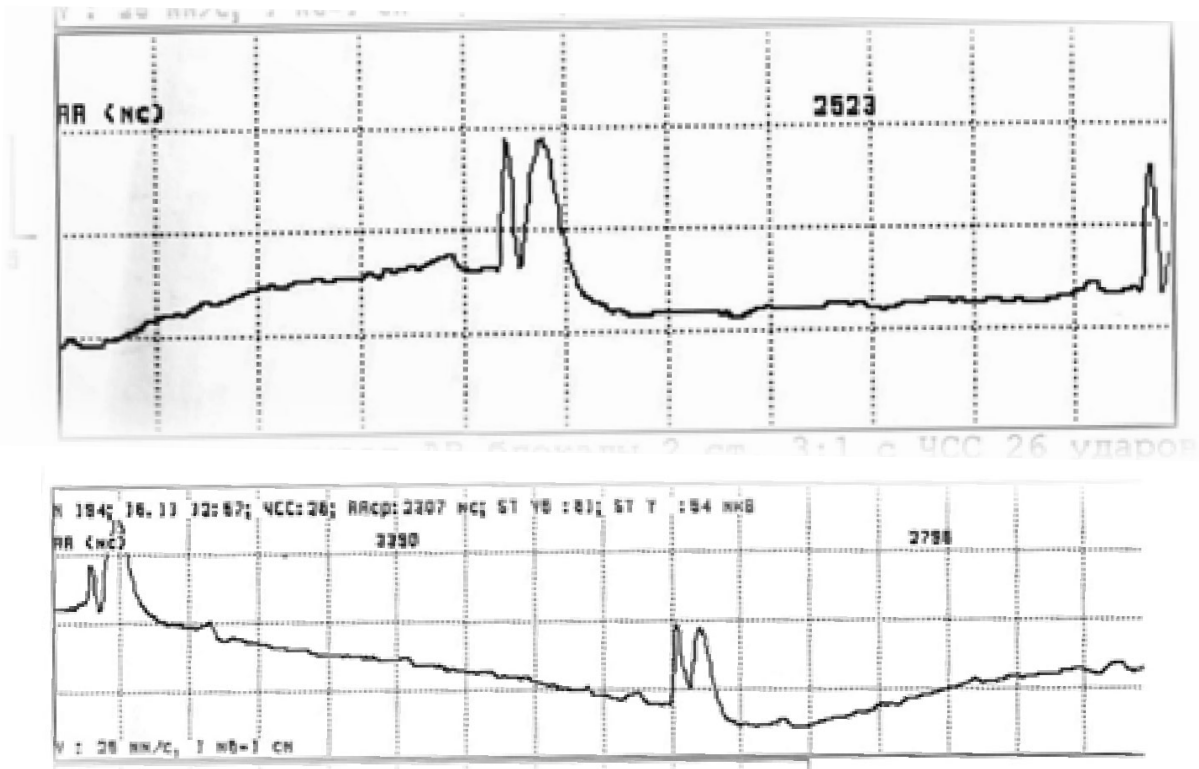


Figure 13. Episode of AB block 2 degree 3: 1 and VR 26 per minute, with high T waves

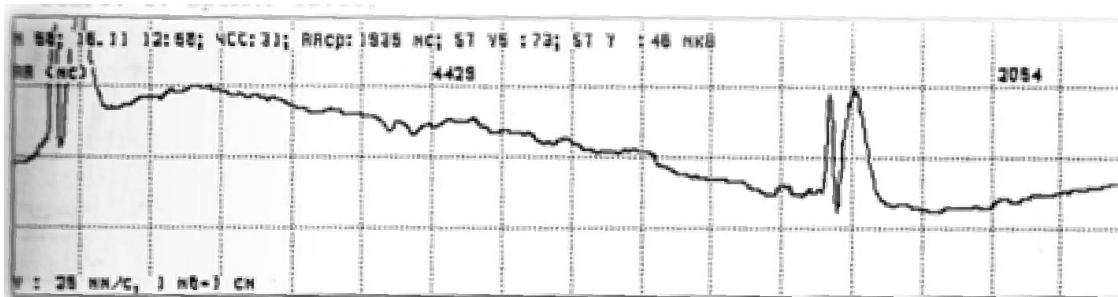


Figure 14. A short episode of atrioventricular block 3rd degree with a pause of 4429 msec

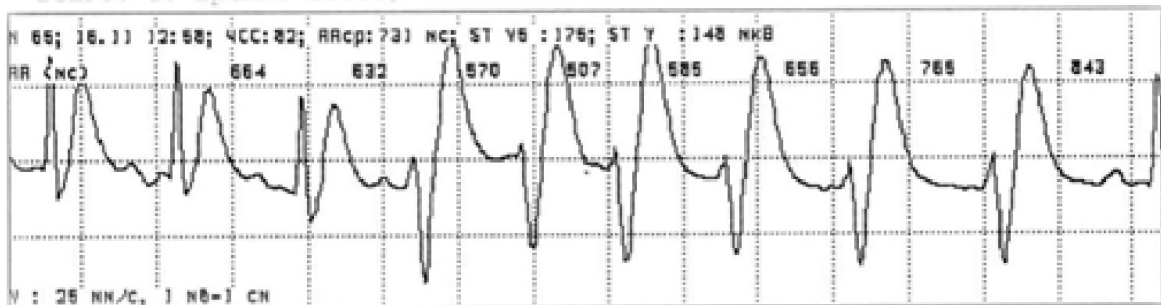


Figure 15. Ventricular tachycardia with VR 99 beats / min

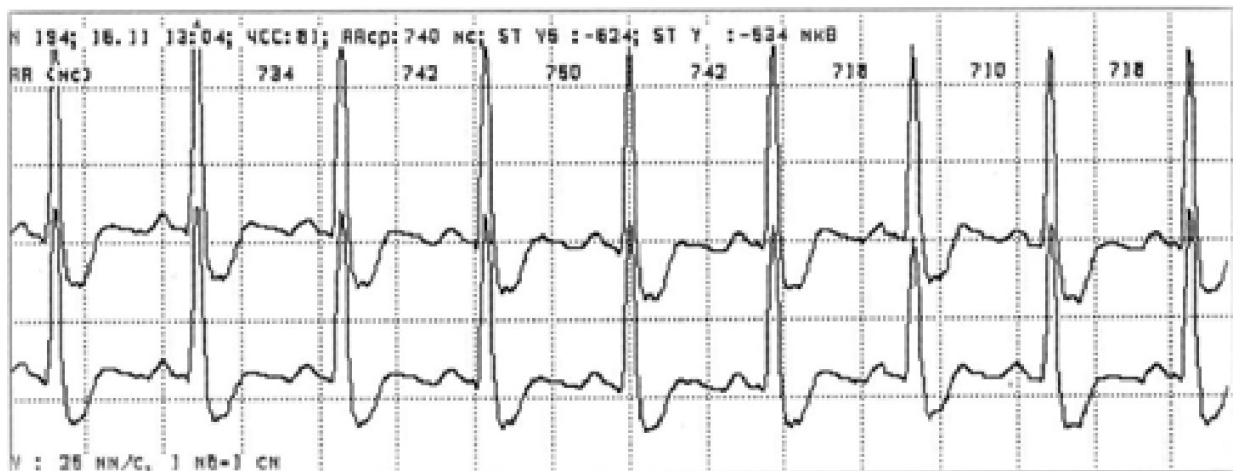


Figure 16. Sinus rhythm restoration

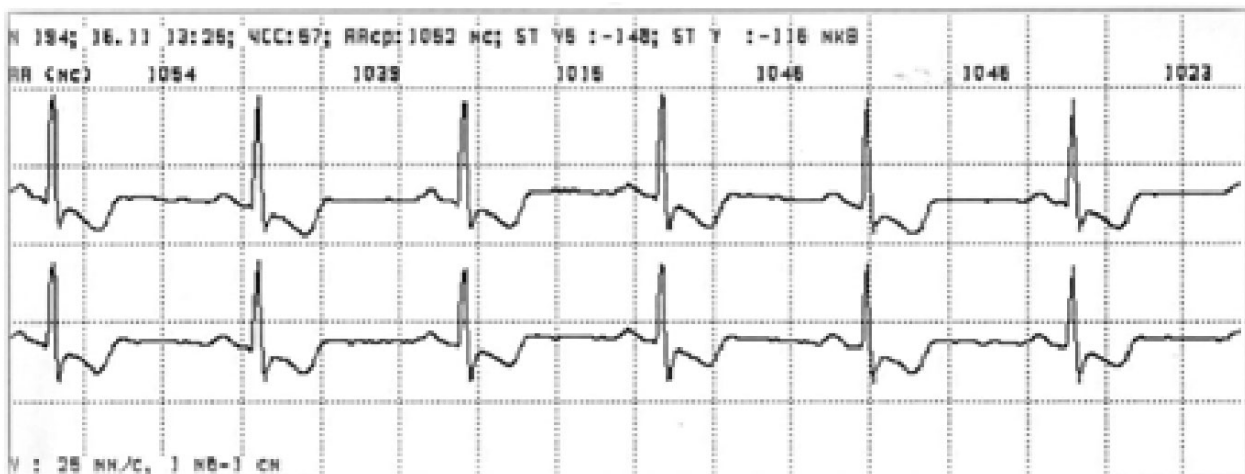


Figure 17. Normalization of intraventricular conduction

### Conclusion

This clinical case is a rare, reliably documented case of sudden cardiac death caused by acute myocardial ischemia spontaneously resolved

### Conflict of Interest Statement

The authors declare no conflict of interest.

### References

1. Campuzano O, Sanchez-Molero O, Fernandez A, Mademont-Soler I, Coll M, et al. Sudden Arrhythmic Death During Exercise: A Post-Mortem Genetic Analysis. *Sports Med.* 2017;47(10):2101–15. <https://doi.org/10.1007/s40279-017-0705-3>
2. Wang F, Liu Y, Liao H, Xue Y, Zhan X, Fang X, et al. Genetic Variants on SCN5A, KCNQ1, and KCNH2 in Patients with Ventricular Arrhythmias during Acute Myocardial Infarction in a Chinese Population. *Cardiology.* 2019;21:1–8. <https://doi.org/10.1159/000502833>



3. Moschovidis V, Simopoulos V, Stravela S, Dipla K, Hatziefthimiou A, Stamatiou R, et al. Dose-Dependent Effects of Ranolazine on Reentrant Ventricular Arrhythmias Induced After Subacute Myocardial Infarction in Rabbits. *J Cardiovasc Pharmacol Ther.* 2020;25(1):65–71. <https://doi.org/10.1177/1074248419858113>
4. Ma S, Ma J, Zhou Y, Guo L, Bai J, Zhang M. Tongguan capsule derived-herb ameliorates remodeling at infarcted border zone and reduces ventricular arrhythmias in rats after myocardial infarction. *Biomed Pharmacother.* 2019;120:109514. <https://doi.org/10.1016/j.biopha.2019.109514>
5. Chen MJ, Bala A, Huddleston JI 3rd, Goodman SB, Maloney WJ, Aaronson AJ, Amanatullah DF. Statin use is associated with less postoperative cardiac arrhythmia after total hip arthroplasty. *Hip Int.* 2019;29(6):618–23. <https://doi.org/10.1177/1120700018816091>
6. Amin M, Kella D, Killu AM, Padmanabhan D, Hodge DO, Golafshar MA, et al. Sudden cardiac arrest and ventricular arrhythmias following first type I myocardial infarction in the contemporary era. *J Cardiovasc Electrophysiol.* 2019 Oct 6. [Epub ahead of print] <https://doi.org/10.1111/jce.14218>
7. Kalarus Z, Svendsen JH, Capodanno D, Dan GA, De Maria E, Gorenek B, et al. Cardiac arrhythmias in the emergency settings of acute coronary syndrome and revascularization: an European Heart Rhythm Association (EHRA) consensus document, endorsed by the European Association of Percutaneous Cardiovascular Interventions (EAPCI), and European Acute Cardiovascular Care Association (ACCA). *Europace.* 2019;21(10):1603–4. <https://doi.org/10.1093/europace/euz163>
8. Islam MS, Islam MN, Kundu SK, Islam MZ, Bhuiyan AS, Haque MM, et al. Serum Albumin Level and In-Hospital Outcome of Patients with First Attack Acute Myocardial Infarction. *Mymensingh Med J.* 2019;28(4):744–51.
9. Jons C, Sogaard P, Behrens S, Schrader J, Mrosk S, Bloch Thomsen PE. The clinical effect of arrhythmia monitoring after myocardial infarction (BIO-GUARD|MI):study protocol for a randomized controlled trial. *Trials.* 2019;20(1):563. <https://doi.org/10.1186/s13063-019-3644-5>
10. Reis PV, Lopes AI, Leite D, Moreira J, Mendes L, Ferraz S, et al. Major Cardiac Events in Patients Admitted to Intensive Care After Vascular Noncardiac Surgery: A Retrospective Cohort. *Semin Cardiothorac Vasc Anesth.* 2019;23(3):293–9. <https://doi.org/10.1177/1089253218825442>
11. Ma S, Ma J, Mai X, Zhao X, Guo L, Zhang M. Danqi soft capsule prevents infarct border zone remodelling and reduces susceptibility to ventricular arrhythmias in post-myocardial infarction rats. *J Cell Mol Med.* 2019;23(8):5454–65. <https://doi.org/10.1111/jcmm.14428>
12. Takada T, Shishido K, Hayashi T, Yokota S, Miyashita H, Yokoyama H, et al. Impact of Late Ventricular Arrhythmias on Cardiac Mortality in Patients with Acute Myocardial Infarction. *J Interv Cardiol.* 2019;2019:5345178. <https://doi.org/10.1155/2019/5345178>

# INTRAFAMILIAL INFECTION OF HELICOBACTER PYLORI: ABNORMAL GASTRIC EPITHELIAL CELLS, PEDESTAL-RICH H. PYLORI ADHERENCE, AND A GENE MUTATION IN A CHILD WITH PROTEIN-LOSING GASTROENTEROPATHY

T.W. Wan<sup>1,2</sup>, O. Khokhlova<sup>1,3</sup>, W. Higuchi<sup>1</sup>, I. Protasova<sup>1,3</sup>, Olga V. Peryanova<sup>3</sup>, L.J. Teng<sup>2</sup>, T. Igarashi<sup>4</sup>, S. Toyoda<sup>5</sup>, T. Yamamoto<sup>1,3</sup>

<sup>1</sup>Department of Epidemiology, Genomics, and Evolution, International Medical Education and Research Center, Niigata, Japan

<sup>2</sup>Department of Clinical Laboratory Sciences and Medical Biotechnology, National Taiwan University College of Medicine, Taipei, Taiwan

<sup>3</sup>Russia-Japan Center of Microbiology, Metagenomics and Infectious Diseases, Krasnoyarsk State Medical University named after Prof. V.F. Voyno-Yasenetsky, Krasnoyarsk, Russia

<sup>4</sup>National Center for Child Health and Development, Tokyo, Japan

<sup>5</sup>Nojiri Children and Family Clinic, Shizuoka, Japan

## Abstract

*Helicobacter pylori*, one of the most prevalent human pathogens, colonizes the gastric mucosa and is associated with gastric diseases, such as gastritis and peptic ulcers, and is also a bacterial risk factor for gastric cancer. Cytotoxin-associated gene A (CagA) protein, a major virulence factor of *H. pylori*, is phosphorylated in cells at its Glu-Pro-Ile-Tyr-Ala (EPIYA) motif and is considered to trigger gastric cancer. CagA is classified into two forms, Western CagA with EPIYA-ABC and East Asian CagA with EPIYA-ABD, with the latter associated with a high risk of developing gastric cancer. CagA causes morphological transformation of cells, yielding the “hummingbird” phenotype in AGS cells and possibly membranous pedestals in the gastric epithelium, albeit rarely. *H. pylori* adherence to the gastric mucosa is not yet fully understood. Here, we describe an intrafamilial infection case of *H. pylori*, focusing on the gastric epithelium, *H. pylori* adherence, and a gene mutation in a child with protein-losing gastroenteropathy (characterized by excessive loss of plasma proteins into the gastrointestinal tract). *H. pylori*, which also infected family members (mother and father), was genetically a single clone with the virulence genes of an East Asian type. The patient’s gastric mucosa exhibited some unique features. Endoscopy revealed the presence of protein plugs on the mucosal surface, which were immunoelectrophoretically similar to serum proteins. Electron microscopy revealed abnormal gastric epithelial cells, totally covered with the secretions or possessing small swollen structures and irregular microvilli. The patient’s *H. pylori* infection was characterized by frequently occurring thick pedestals, formed along adherent *H. pylori*. The serum protein level returned to normal and the protein plugs disappeared after the successful eradication of *H. pylori*, albeit with lag periods for healing. He had a mutation in the *OCRL1* gene, associated with Dent disease (asymptomatic proteinuria). Thus, in the patient’s gastric mucosa, we found the abnormal gastric epithelial cells, which may be caused by an *OCRL1* mutation or *H. pylori*, and pedestal-rich *H. pylori* infection, possibly caused by a higher level of action of CagA in the abnormal epithelial cells. The data suggests a novel *H. pylori* virulence factor associated with “excessive plasma protein release”.

## Keywords

*Helicobacter pylori* • intrafamilial infection • protein-losing gastroenteropathy • protein plugs • eradication therapy • gastric epithelial cell • pedestal • CagA • gastric cancer • *OCRL1*

## Introduction

*Helicobacter pylori* is a gram-negative, spiral-shaped bacterium with one to two turns along the axis, and has multiple (four to six) polar flagella to facilitate marked motility [1-3]. *H. pylori* colonizes the gastric mucosal niche via an oral route, and for its establishment, high *H. pylori* motility

and urease activities are critical [4-6]. *H. pylori* is one of the most prevalent human pathogens with a long history related to the migration of mankind [7-9]. Transmission among family members, particularly mother-to-child, constitutes the core route of *H. pylori* infection, with children being at

a high risk [10-12]. Its infection is associated with gastritis, peptic ulcers, and mucosa-associated lymphoid tissue lymphoma, and is also a bacterial risk factor for gastric cancer [3, 10, 13, 14].

Among virulence factors of *H. pylori*, cytotoxin-associated gene A (CagA) protein, vacuolating cytotoxin A (VacA), and antigen induced by contact with epithelium (IceA) are the most noted in terms of a fully virulent type [15]. Regarding CagA protein, it is injected into the gastric epithelial cells through the type IV secretion system (encoded by *cag* pathogenicity island, *cag* PAI, carrying *cagA* and *cagE*) [16], resulting in phosphorylation of injected CagA protein at the Glu-Pro-Ile-Tyr-Ala (EPIYA) motifs [17-21], with this leading to cellular cytoskeletal rearrangements, abnormal cell growth and motility, and gastric cancer [14, 20, 22, 23].

The type and repetitions of the CagA EPIYA tyrosine phosphorylation motifs at the 3'-end reflect geographic distribution and virulence (especially gastric cancer risk) [19, 23]. Of the CagAEPIYA types, EPIYA-C is found in Europe, the USA, and Australia. Thus, CagA with EPIYA-C is designated Western CagA. EPIYA-D is found in East Asian countries in those at high risk for gastric cancer, and is designated as East Asian CagA. CagA EPIYA-AB is common; thus CagA EPIYA-ABC and -ABD are predominant Western CagA and East Asian CagA, respectively.

Cag A-induced cellular morphology (cytoskeletal rearrangement) has also been noted. In transformed gastric epithelial AGS cells, CagA protein causes the "hummingbird" phenotype [14, 22]. In the gastric mucosa (biopsy specimens), *H. pylori* often shows intimate adherence, appearing as membranous pedestal [24, 25] or ruffle [11] formation, considered to be caused by CagA. Unique features of *H. pylori* adherence on the gastric mucosa also include a phenotype appearing as the shrinking of epithelial cells, surrounded by *H. pylori* (Supplementary Fig. S1). The mechanisms of *H. pylori* adherence on the human gastric mucosa are not yet fully understood. In this report, we describe an intrafamilial *H. pylori* infection case, focusing on the gastric epithelium, *H. pylori* adherence, and a gene mutation in a child (male) with protein-losing gastroenteropathy, a disease characterized by excessive loss of plasma proteins into the gastrointestinal tract [26-31].

## Materials and Methods

### Case

Gastric biopsy specimens were taken from members of a family living in Yokohama, Japan. The patient was a 5-year-old boy. Proteinuria was noted on a routine health examination at the age of 3 years, and he was diagnosed with idiopathic tubular

proteinuria (Dent disease), which is caused by mutations of the *CLCN5* and *OCRL1* genes [32-34]. His paternal grandfather died of gastric cancer. On the day of admission, he was noted to have fever and edema of the eyelids and on the anterior aspect of the legs. Laboratory tests showed hypoproteinemia with hypoalbuminemia and hypogammaglobulinemia. Fecal  $\alpha$  1-antitrypsin clearance was increased, and technetium-99m ( $^{99m}\text{Tc}$ ) scintigraphy showed radionuclide excretion into the intestinal tract. Endoscopy revealed numerous protein plugs in the gastric body (Fig. 1). The protein plugs in the gastric body were extracted endoscopically and subjected to immunoelectrophoresis. The protein levels were 2,336.4 mg/dL and exhibited a composition of albumin 48.0%,  $\beta$ -globulin 16.9%,  $\alpha$ 1-globulin 14.6%,  $\alpha$ 2-globulin 12.8%, and  $\gamma$ -globulin 7.7%, similar to serum levels. Thus, he was diagnosed with protein-losing gastroenteropathy. Histological examination using hematoxylin and eosin staining showed features of atrophic hyperplastic gastritis (chronic pangastritis) with lymphoid hyperplasia in the gastric body, gastric antrum, and duodenal bulb (Fig. 1). Cultures of the gastric antral mucosa were positive for *H. pylori*. *H. pylori* infection was successfully eradicated by two courses of triple therapy (two and three weeks with 3-week intervals) with clarithromycin (20 mg/kg/day), amoxicillin (50 mg/kg/day), and the proton pump inhibitor lansoprazole (1.5 mg/kg/day), according to Japanese guidelines [35]. The serum protein levels returned to normal one year later. At the age of 11 years, the fluctuating levels of total serum protein and albumin were successfully maintained at 6.0 and 4.0 g/dL, respectively. The protein plugs decreased but persisted in the gastric body and gastric antrum six months after the eradication therapy (Fig. 2); however, at the age of 11 years, the protein plugs disappeared almost completely, but with some even 10 years after the eradication therapy. His 36-year-old father and 32-year-old mother were asymptomatic *H. pylori* carriers, and endoscopically diagnosed with chronic gastritis. This study was approved by the Ethical Committee of the Hospital. Informed consent was obtained from the parents.

### Media and bacterial growth

*H. pylori* was isolated from biopsy specimens by culturing at 37°C in a microaerophilic atmosphere (10% O<sub>2</sub> and 10% CO<sub>2</sub>) on *H. pylori*-selective plates containing trimethoprim, polymyxin B, vancomycin, and amphotericin B to inhibit the growth of microbes other than *H. pylori* (Nissui Pharmaceuticals, Tokyo, Japan). *H. pylori* was subcultured on 5% sheep blood agar (Becton Dickinson, Tokyo) and then stored at -80°C.

### Electron microscopy

Biopsy specimens of the gastric antrum were washed in saline, fixed with 2.5% (vol/vol) glutaraldehyde, and

postfixed in 1% osmium tetroxide. Samples were then dehydrated with ethanol. For scanning electron microscopy (SEM), dehydrated samples were then critical-point dried, coated with gold-palladium, and subjected to SEM [11]. For transmission electron microscopy (TEM), dehydrated samples were embedded in epoxy resin (EPOK812; Ouken, Tokyo), and cut with an ultramicrotome diamond knife, followed by staining with uranyl acetate and lead citrate [11].

### **Bacterial DNA isolation**

*H. pylori* cells, grown in brain heart infusion broth containing 10% fetal bovine serum, were suspended in 10 mM Tris-HCl (pH 8.0) containing 1 mM EDTA and then lysed by the addition of sodium dodecyl sulfate (0.5%) and proteinase K (100 µg/mL). After treatment with cetyltrimethylammonium bromide (1% in the presence of 0.7 M sodium chloride) and subsequently with chloroform/isoamyl alcohol (24:1) and phenol/chloroform/isoamyl alcohol (25:24:1), DNA in the aqueous solution was precipitated with a 0.6 volume of isopropanol. The DNA was then rinsed with 70% ethanol and redissolved in 10 mM Tris-HCl (pH 8.0) containing 1 mM EDTA [11].

### **HindIII-digestion pattern analysis**

Bacterial DNA was digested with *HindIII* and the digests were electrophoresed on 0.8% agarose gels with a 1-kb DNA ladder (Life Technologies, Gaithersburg, MD, USA), which was used as the molecular size standard. The gel was stained with ethidium bromide [11].

### **Plasmid analysis**

Plasmid analysis was carried out essentially by a published method [36]. Plasmid DNA was analyzed by electrophoresis in 0.5% agarose gel with reference plasmid DNAs of known molecular size. The gel was stained with ethidium bromide.

### **Virulence gene analysis for *H. pylori***

*H. pylori* virulence genes, *cagA*, *cagE*, *vacA* (s/m types), *iceA1*, *iceA2*, and *babA2*, were analyzed by PCR using the primers listed in Table 1 [17, 37-40].

### **CagA EPIYA motif analysis**

The CagA EPIYA motif region of the *cagA* gene was amplified by PCR using the primers listed in Table 1 and the PCR products were sequenced [17, 19].

### **CLCN5 and OCRL1 gene analysis**

Peripheral blood lymphocyte DNA from the patient (boy) and his mother was used for *CLCN5* and *OCRL1* gene analysis. The coding region and exon-intron boundaries were amplified by PCR and the PCR products were sequenced [41, 42].

### **Motion analysis**

*H. pylori* motility in a liquid layer of brain heart infusion broth containing 10% fetal bovine serum was examined under an inverted, phase-contrast microscope at 37°C. The motility speed (µm/s) was measured using a motion analysis system with the program C-Imaging C-MEN (Complx Inc., PA, USA) [2, 43].

## **Results**

### **Genetic features of *H. pylori***

Direct comparison of the *HindIII*-digests of *H. pylori* DNA revealed that all the *H. pylori* strains were very similar to each other (Fig. 3A, lanes 1 to 3), although the father's strain was slightly divergent from the patient's and mother's strains. All *H. pylori* strains possessed the same cryptic plasmid with a size of 4.5 kb (Fig. 3B, lanes 2 to 4).

Next, the virulence genotypes of *H. pylori* were examined by PCR. All *H. pylori* strains exhibited the same genotype of *cagA*, *cagE*, *vacA* s1c/m1, *iceA1*, and *babA2*, which is a virulent genotype predominantly found in Japan and neighboring Asian countries [15, 37, 44].

The CagA EPIYA motif of all *H. pylori* strains was ABD, suggesting the East-Asian (virulent) type (Fig. 4) [17, 19, 44]. Again, the CagA EPIYA motif B of the father's strain was divergent by one amino acid residue from those of the patient and mother (Fig. 4B).

All *H. pylori* strains were highly motile, with the mean swimming speed being 70 to 80 µm/s [2, 43].

### ***H. pylori* adherence features in biopsy specimens**

First, the patient's biopsy specimens were analyzed. Regarding SEM, the surface of the gastric epithelial cells was nearly completely covered with secretions (Fig. 5A). Therefore, adherent *H. pylori* was only rarely seen on the gastric epithelium (Fig. 5B and C). The SEM study also revealed abnormalities of the patient's gastric epithelial cells, possessing many small swollen structures (Fig. 5B) and irregular and long microvilli at the apical surface (Fig. 5B and C). These morphological features were in marked contrast to the parents' gastric epithelial cells, as described below.

When analyzed by TEM, numerous *H. pylori* were observed on the mucosa; however, the manner of *H. pylori* adherence was unusual. Many *H. pylori* intimately attached to the gastric epithelial cells, and roughly 25% formed typical pedestals (or cups), i.e., thick membranous projections along the adherent *H. pylori* body (Fig. 6A to C). *H. pylori* also adhered to the microvilli of the epithelial cells (Fig. 6D).

Next, the mother's biopsy specimens were analyzed. Regarding SEM, the gastric epithelial cells had regular and

short microvilli with *H. pylori* adherence (Fig. 7A and B). Regarding TEM, no typical pedestals were observed, with pedestal-like structures (small membranous projections attached to a part of the *H. pylori* body) being present rarely (Fig. 6C). Many *H. pylori* adhered to the gastric epithelial cells via filaments (Fig. 7C) and microvilli (Fig. 7D).

Finally, the father's biopsy specimens were analyzed. Regarding SEM, the gastric epithelial cells had regular and short microvilli with the most high-level *H. pylori* adherence among the family members (Fig. 8A and B). Regarding TEM, there were no typical pedestals, with pedestal-like structures being present rarely (Fig. 8C). Many *H. pylori* adhered to the gastric epithelial cells via filaments (Fig. 8D) and microvilli (Fig. 7E).

### **CLCN5 and OCRL1 gene mutations**

The patient's and mother's DNA samples were subjected to *CLCN5* and *OCRL1* gene mutation analysis. The patient's *OCRL1* gene had an Arg318Cys (codon CGC vs. TGC) mutation. The mother's *OCRL1* gene had no mutations. There were no mutations in their *CLCN5* genes.

## **Discussion**

In the present study, a 5-year-old boy was diagnosed with panchronic gastritis and protein-losing gastroenteropathy, endoscopically, histologically, and also by serum protein analysis and using  $^{99m}\text{Tc}$  scintigraphy [26-31]. He was infected with *H. pylori* and had lymphoid hyperplasia and atrophy in the gastric mucosa. He also had the protein plugs on the gastric mucosa, which were immunoelectrophoretically similar to serum proteins.

*H. pylori* infection was successfully eradicated, and his symptoms on protein-losing gastroenteropathy returned to normal one year after *H. pylori* eradication, as has been reported by others [27-30]. The protein plugs on the gastric mucosa decreased, but persisted longer after *H. pylori* eradication.

*H. pylori* from the patient and his parents were genetically a single clone, suggesting intrafamilial transmission of *H. pylori*, including that between parents and parent-to-child transmission. The *H. pylori* exhibited an East Asian virulent genotype, which is a high risk for gastric cancer [15, 17, 19, 37, 40, 44]. Since the patient's paternal grandfather died of gastric cancer, the familial *H. pylori* may originate in their ancestors.

We investigated the gastric mucosa of the three family members by SEM and TEM, and found that the gastric mucosa of the patient with protein-losing gastroenteropathy was abnormal in terms of the gastric epithelial cells. The patient's epithelial cells were totally covered with the secretions or had

small swollen structures and irregular and long microvilli at the apical surface, in marked contrast to those of the parents. On the abnormal gastric epithelium of the patient, *H. pylori* exhibited unusual adherence behaviors, in such a way that it showed significant pedestal formation with thick membranous projections along the whole adherent *H. pylori* body. There is a possibility that *H. pylori* CagA PAI injects more CagA into the patient's epithelial cells, resulting in the patient's frequent and thick pedestals. If this hypothesis is correct, pedestal formation levels observed in biopsy specimens may reflect in vivo CagA activity levels, triggering the progression to gastric cancer. Such *H. pylori*-induced typical pedestals as the patient's case were not found in his parents' mucosa, although "pedestal-like structures" were present.

His symptoms also met the criteria for Dent disease, that is a renal proximal tubular disorder characterized by low-molecular-weight proteinuria, hypercalciuria, and nephrocalcinosis [32-34]. Dent disease is caused by mutations in the *CLCN5* gene or *OCRL1* gene (which is known as a cause of Lowe syndrome) [32-34]. Therefore, we investigated the *CLCN5* and *OCRL1* genes of the patient and his mother for mutations, and found that the patient (but not his mother) had an Arg318Cys (codon CGC vs. TGC) mutation in the *OCRL1* gene; this mutation is found in less than 10% of Dent disease patients. Thus, the patient's abnormal epithelial cells may be caused by an *OCRL1* mutation or by *H. pylori* infection.

We suggest that thick pedestal formation, frequently occurring in the abnormal epithelial cells, is a CagA-associated event. However, protein-losing gastroenteropathy and the protein plugs (and also the abnormal gastric epithelial cells) may not be explained by previously published *H. pylori* virulence factors, suggesting a novel *H. pylori* virulence factor/toxin (X) associated with "excessive loss of plasma proteins into the gastrointestinal tract". Further studies are required for better understanding of protein-losing gastroenteropathy.

Finally, when we analyzed *H. pylori* strains, isolated from Vladivostok, Russia, the most prevalent type were *cagA* (EPIYA-ABC)/*vacA* (s1/m1), suggesting a Western type [44]; no *cagA* (EPIYA-ABD) was detected. This was in marked contrast to *H. pylori* strains from East Asia including China, Korea, and Japan, where *cagA* (EPIYA-ABD) is predominant [18, 19, 23]. The predominance of a Western *cagA* type in Vladivostok was considered to be due to large population migration from European/Central Russia (or Eastern Europe) to Far Eastern Russia for 200 years [44].

## **Conclusion**

In an intrafamilial infection from an East Asian virulent type of *H. pylori*, a boy (patient) suffered from protein-losing



gastroenteropathy. His gastric mucosa had the protein plugs, abnormal epithelial cells, and *H. pylori*-induced typical membranous pedestals. *H. pylori* infection was successfully eradicated, with healing of protein-losing gastroenteropathy and the protein plugs, albeit with lag periods. He had a mutation in the *OCRL1* gene, which may be related to his gastrointestinal disease. We consider that the patient's pedestal formation is a CagA-associated event, with a high CagA action in the abnormal epithelial cells. Protein-losing gastroenteropathy and the protein plugs (and also abnormal epithelial cells) may be caused by an unknown virulence factor (toxin) of *H. pylori*. Pedestal formation levels in biopsy specimens may serve as a risk marker for potential progression to gastric cancer.

## References

- Josenhans C, Labigne A, Suerbaum S. Comparative ultrastructural and functional studies of *Helicobacter pylori* and *Helicobacter mustelae* flagellin mutants: both flagellin subunits, FlaA and FlaB, are necessary for full motility in *Helicobacter* species. *J Bacteriol.* 1995;177(11):3010–20. <https://doi.org/10.1128/jb.177.11.3010-3020.1995>
- Tsutsui N, Taneike I, Ohara T, Goshi S, Kojio S, Iwakura N, et al. A novel action of the proton pump inhibitor rabeprazole and its thioether derivative against the motility of *Helicobacter pylori*. *Antimicrob Agents Chemother.* 2000;44(11):3069–73. <https://doi.org/10.1128/aac.44.11.3069-3073.2000>
- Kusters JG, van Vliet AH, Kuipers EJ. Pathogenesis of *Helicobacter pylori* infection. *Clin Microbiol Rev.* 2006;19(3):449–90. <https://doi.org/10.1128/CMR.00054-05>
- Gu H. Role of flagella in the pathogenesis of *Helicobacter pylori*. *Curr Microbiol.* 2017;74(7):863–9. <https://doi.org/10.1007/s00284-017-1256-4>
- Waskito LA, Salama NR, Yamaoka Y. Pathogenesis of *Helicobacter pylori* infection. *Helicobacter.* 2018;23 Suppl 1:e12516. <https://doi.org/10.1111/hel.12516>
- Quaglia NC, Dambrosio A. *Helicobacter pylori*: A foodborne pathogen? *World J Gastroenterol.* 2018;24(31):3472–87. <https://doi.org/10.3748/wjg.v24.i31.3472>
- Maixner F, Krause-Kyora B, Turaev D, Herbig A, Hoopmann MR, Hallows JL, et al. The 5300-year-old *Helicobacter pylori* genome of the Iceman. *Science.* 2016;351(6269):162–5. <https://doi.org/10.1126/science.aad2545>
- Mégraud F, Lehours P, Vale FF. The history of *Helicobacter pylori*: from phylogeography to paleomicrobiology. *Clin Microbiol Infect.* 2016;22(11):922–7. <https://doi.org/10.1016/j.cmi.2016.07.013>
- Waskito LA, Yamaoka Y. The story of *Helicobacter pylori*: Depicting human migrations from the phylogeography. *Adv Exp Med Biol.* 2019;1149:1–16. [https://doi.org/10.1007/5584\\_2019\\_356](https://doi.org/10.1007/5584_2019_356)
- Covacci A, Telford JL, Del Giudice G, Parsonnet J, Rappuoli R. *Helicobacter pylori* virulence and genetic geography. *Science.* 1999;284(5418):1328–33. <https://doi.org/10.1126/science.284.5418.1328>
- Taneike I, Tamura Y, Shimizu T, Yamashiro Y, Yamamoto T. *Helicobacter pylori* intrafamilial infections: Change in source of infection of a child from father to mother after eradication therapy. *Clin Diagn Lab Immunol.* 2001;8(4):731–9. <https://doi.org/10.1128/CDLI.8.4.731-739.2001>
- Buruco C, Axon A. Epidemiology of *Helicobacter pylori* infection. *Helicobacter.* 2017;22 Suppl 1:e12403. <https://doi.org/10.1111/hel.12403>
- Graham DY. *Helicobacter pylori* update: gastric cancer, reliable therapy, and possible benefits. *Gastroenterology.* 2015;148(4):719–31.e3. <https://doi.org/10.1053/j.gastro.2015.01.040>
- Mégraud F, Bessède E, Varon C. *Helicobacter pylori* infection and gastric carcinoma. *Clin Microbiol Infect.* 2015;21(11):984–90. <https://doi.org/10.1016/j.cmi.2015.06.004>
- Imkamp F, Lauener FN, Pohl D, Lehours P, Vale FF, Jehanne Q, et al. Rapid characterization of virulence determinants in *Helicobacter pylori* isolated from non-atrophic gastritis patients by next-generation sequencing. *J Clin Med.* 2019;8(7):E1030. <https://doi.org/10.3390/jcm8071030>
- Backert S, Haas R, Gerhard M, Naumann M. The *Helicobacter pylori* type IV secretion system encoded by the *cag* pathogenicity island: Architecture, function, and signaling. *Curr Top Microbiol Immunol.* 2017;413:187–220. [https://doi.org/10.1007/978-3-319-75241-9\\_8](https://doi.org/10.1007/978-3-319-75241-9_8)
- Yamaoka Y, Kodama T, Kashima K, Graham DY, Sepulveda AR. Variants of the 3' region of the *cagA* gene in *Helicobacter pylori* isolates from patients with different *H. pylori*-associated diseases. *J Clin Microbiol.* 1998;36(8):2258–63.

## Acknowledgments

We thank Tomomi Takano and Ikue Taneike for technical information. This study was supported by the institutions of the authors, including personal money obtained from lectures at universities and colleges (TY).

## Conflict of Interest Statement

The authors declare that they have no conflicts of interest.



18. Backert S, Tegtmeyer N, Selbach M. The versatility of *Helicobacter pylori* CagA effector protein functions: The master key hypothesis. *Helicobacter*. 2010;15(3):163–76. <https://doi.org/10.1111/j.1523-5378.2010.00759.x>
19. Hatakeyama M. Anthropological and clinical implications for the structural diversity of the *Helicobacter pylori* CagA oncoprotein. *Cancer Sci*. 2011;102(1):36–43. <https://doi.org/10.1111/j.1349-7006.2010.01743.x>
20. Hatakeyama M. *Helicobacter pylori* CagA and gastric cancer: A paradigm for hit-and-run carcinogenesis. *Cell Host Microbe*. 2014;15(3):306–16. <https://doi.org/10.1016/j.chom.2014.02.008>
21. Su H, Tissera K, Jang S, Choi YH, Kim A, Cho YJ, et al. Evolutionary mechanism leading to the multi-cagA genotype in *Helicobacter pylori*. *Sci Rep*. 2019;9(1):11203. doi: 10.1038/s41598-019-47240-2
22. Hatakeyama M. Structure and function of *Helicobacter pylori* CagA, the first-identified bacterial protein involved in human cancer. *Proc Jpn Acad Ser B Phys Biol Sci*. 2017;93(4):196–219. <https://doi.org/10.2183/pjab.93.013>
23. Hatakeyama M. Malignant *Helicobacter pylori*-Associated Diseases: Gastric Cancer and MALT Lymphoma. *Adv Exp Med Biol*. 2019;1149:135–49. [https://doi.org/10.1007/5584\\_2019\\_363](https://doi.org/10.1007/5584_2019_363)
24. Blom J, Gernow A, Holck S, Wewer V, Nørgaard A, Graff LB, et al. Different patterns of *Helicobacter pylori* adherence to gastric mucosa cells in children and adults. An ultrastructural study. *Scand J Gastroenterol*. 2000;35(10):1033–40. <https://doi.org/10.1080/003655200451144>
25. Chun HJ, Park DK, Park CH, Park JH, Jeon YT, Um SH, et al. Electron microscopic evaluation of adhesion of *Helicobacter pylori* to the gastric epithelial cells in chronic gastritis. *Korean J Intern Med*. 2002;17(1):45–50. <https://doi.org/10.3904/kjim.2002.17.1.45>
26. Sullivan PB, Thomas JE, Eastham EJ, Lunn PG, Neale G. *Helicobacter pylori* and protein losing enteropathy. *Arch Dis Child*. 1990;65(3):332–3. <https://doi.org/10.1136/adc.65.3.332-a>
27. Cohen HA, Shapiro RP, Frydman M, Varsano I. Childhood protein-losing enteropathy associated with *Helicobacter pylori* infection. *J Pediatr Gastroenterol Nutr*. 1991;13(2):201–3. <https://doi.org/10.1097/00005176-199108000-00015>
28. Bayerdörffer E, Ritter MM, Hatz R, Brooks W, Ruckdeschel G, Stolte M. Healing of protein losing hypertrophic gastropathy by eradication of *Helicobacter pylori* - Is *Helicobacter pylori* a pathogenic factor in Ménétrier's disease? *Gut*. 1994;35(5):701–4. <https://doi.org/10.1136/gut.35.5.701>
29. Madisch A, Aust D, Morgner A, Grossmann D, Schmelz R, Kropp J, et al. Resolution of gastrointestinal protein loss after *Helicobacter pylori* eradication in a patient with hypertrophic lymphocytic gastritis. *Helicobacter*. 2004;9(6):629–31. <https://doi.org/10.1111/j.1083-4389.2004.00275.x>
30. Sato T, Chiguchi G, Inamori M, Sakai H, Fujisawa N, Akiyama T, et al. Protein-losing gastroenteropathy and gastric polyps: Successful treatment by *Helicobacter pylori* eradication. *Digestion*. 2007;75(2-3):99. <https://doi.org/10.1159/000102965>
31. Sasaki Y, Abe Y, Ueno Y. A rare cause of protein-losing gastropathy. *Gastroenterology*. 2016;150(5):1094–5. <https://doi.org/10.1053/j.gastro.2016.01.042>
32. Bökenkamp A, Ludwig M. The oculocerebrorenal syndrome of Lowe: An update. *Pediatr Nephrol*. 2016;31(12):2201–12. <https://doi.org/10.1007/s00467-016-3343-3>
33. Ehlayel AM, Copelovitch L. Update on Dent disease. *Pediatr Clin North Am*. 2019;66(1):169–78. <https://doi.org/10.1016/j.pcl.2018.09.003>
34. Anglani F, Gianesello L, Beara-Lasic L, Lieske J. Dent disease: A window into calcium and phosphate transport. *J Cell Mol Med*. 2019;23(11):7132–42. <https://doi.org/10.1111/jcmm.14590>
35. Japanese Society for Pediatric Gastroenterology, Hepatology and Nutrition. [The updated JSPGHAN guidelines for the management of *Helicobacter pylori* infection in childhood 2018]. [site]. [cited 2019 Oct 3]. Available from: [http://www.jspghan.org/images/helicobacter\\_guideline2018.pdf](http://www.jspghan.org/images/helicobacter_guideline2018.pdf)
36. Khokhlova OE, Hung WC, Wan TW, Iwao Y, Takano T, Higuchi W, et al. Healthcare- and community-associated methicillin-resistant *Staphylococcus aureus* (MRSA) and fatal pneumonia with pediatric deaths in Krasnoyarsk, Siberian Russia: unique MRSA's multiple virulence factors, genome, and stepwise evolution. *PLoS One*. 2015;10(6):e0128017. <https://doi.org/10.1371/journal.pone.0128017>
37. Yamaoka Y, Kodama T, Gutierrez O, Kim JG, Kashima K, Graham DY. Relationship between *Helicobacter pylori* *iceA*, *cagA*, and *vacA* status and clinical outcome: studies in four different countries. *J Clin Microbiol*. 1999;37(7):2274–9.
38. Gerhard M, Lehn N, Neumayer N, Borén T, Rad R, Schepp W, et al. Clinical relevance of the *Helicobacter pylori* gene for blood-group antigen-binding adhesin. *Proc Natl Acad Sci U S A*. 1999;96(22):12778–83. <https://doi.org/10.1073/pnas.96.22.12778>
39. Atherton JC, Cao P, Peek RM Jr, Tummuru MK, Blaser MJ, Cover TL. Mosaicism in vacuolating cytotoxin alleles of *Helicobacter pylori*. Association of specific *vacA* types with cytotoxin production and peptic ulceration. *J Biol Chem*. 1995;270(30):17771–7. <https://doi.org/10.1074/jbc.270.30.17771>
40. McClain MS, Beckett AC, Cover TL. *Helicobacter pylori* vacuolating toxin and gastric cancer. *Toxins (Basel)*. 2017;9(10): E316. <https://doi.org/10.3390/toxins9100316>
41. Igarashi T, Inatomi J, Ohara T, Kuwahara T, Shimadzu M, Thakker RV. Clinical and genetic studies of CLCN5 mutations in Japanese families with Dent's disease. *Kidney Int*. 2000;58(2):520–7. <https://doi.org/10.1046/j.1523-1755.2000.00198.x>
42. Sekine T, Nozu K, Iyengar R, Fu XJ, Matsuo M, Tanaka R, et al. *OCRL1* mutations in patients with Dent disease phenotype in Japan. *Pediatr Nephrol*. 2007;22(7):975–80. <https://doi.org/10.1007/s00467-007-0454-x>

43. Kushiya K, Taneike I, Nakagawa S, Zhang HM, Gejyo F, Yamamoto T. A study on the regulation and energy requirements of *Helicobacter pylori* motility and its inhibitors. *Acta Med Biol (Niigata)*. 2004;52(4):133–40.
44. Reva I, Takano T, Higuchi W, Iwao Y, Taneike I, Nakagawa S, et al. Virulence genotypes and drug resistance of *Helicobacter pylori* from Vladivostok, Russia: Another feature in the Far East. *Microbiol Immunol*. 2012;56(3):198–202. <https://doi.org/10.1111/j.1348-0421.2011.00425.x>

**Table Captions**

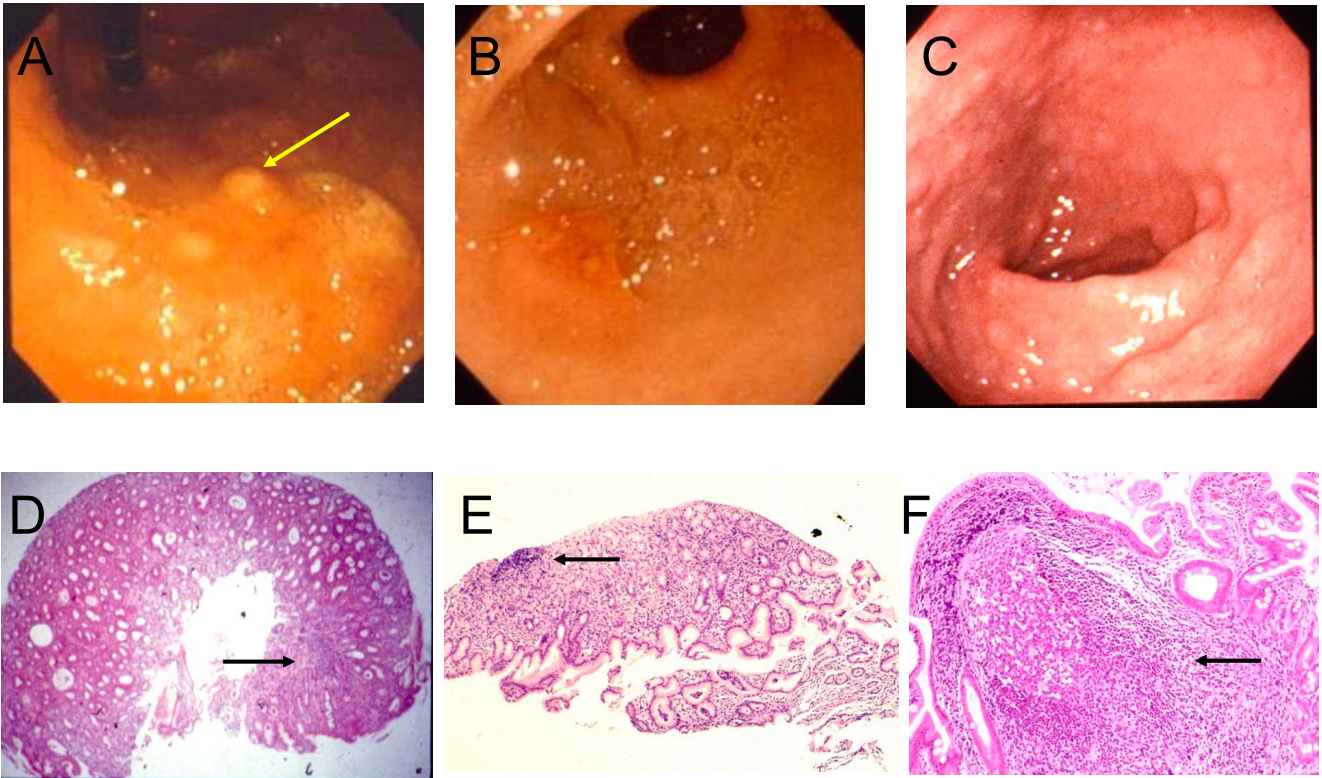
**Table 1.** Primers used for the PCR assaying of *H. pylori* virulence genes

Primer (F/R set)	Primer sequence (5'→3')	Product size (bp)	Target/ application	Reference
CAGAF/ CAGAR	GATAACAGGCAAGCTTTTGAGG CTGCAAAAGATTGTTTGGCAGA	349	<i>cagA</i>	37
CAGEF/ CAGER	TGCTGATACGATTAGAGA TAGTCCCTTAGTGATGAT	127	<i>cagE</i>	37
GAG1(F)/ CAG2(R)	ACCCTAGTCGGTAATGGGTTA GTAATTGTCTAGTTTCGC	Variable	<i>cagA</i> EPIYA motif analysis	17
GAG1(F)a/ CAG2(R)a	ACCCTAGTCGGTAATGGGTTG GTAATTGTCCAATTTTCGC	Variable	<i>cagA</i> EPIYA motif analysis	This study
GAG1(F)b/ CAG2(R)b	GGAACCCTAGTCGGTAATG ATCTTTGAGTTCATCTATCT	Variable	<i>cagA</i> EPIYA motif analysis	This study
iceA1F/ iceA1R	GTGTTTTTAACCAAAGTATC CTATAGCCAGTCTCTTTGCA	247	<i>iceA1</i>	37, this study
iceA2F/ iceA2R	GTTGGGTATATCACAATTTCA TTACCCTATTTCTAGTAGGT	229/334	<i>iceA2</i>	37, this study
babA2F/ babA2R	AATCCAAAAAGGAGAAAAAGTATGAAA TGTTAGTGATTTCCGGTGTAGGACA	832	<i>babA2</i>	38
VA1-F/ VA1-R	ATGGAATACAACAACACACAC CTGCTTGAATGCGCCAAAC	259	<i>vacA</i> s1	37, 39
VA1-F/ VA1-R	ATGGAATACAACAACACACAC CTGCTTGAATGCGCCAAAC	286	<i>vacA</i> s2	37, 39
SS2-F/ VA1-R	GCTAACACGCCAATGATCC CTGCTTGAATGCGCCAAAC	199	<i>vacA</i> s2	39
SS1-F/ VA1-R	GTCAGCATCACACCGCAAC CTGCTTGAATGCGCCAAAC	190	<i>vacA</i> s1a	39
S1A-F/ VA1-R	TCTCGCTTTAGTAGGAGC CTGCTTGAATGCGCCAAAC	212	<i>vacA</i> s1a	37, this study
SS3-F/ VA1-R	AGCGCCATACCGCAAGAG CTGCTTGAATGCGCCAAAC	187	<i>vacA</i> s1b	37, 39
S1C-F/ VA1-R	CTCGCTTTAGTAGGGCTA CTGCTTGAATGCGCCAAAC	213	<i>vacA</i> s1c	37, this study
VAG-F/ VAG-R	CAATCTGTCCAATCAAGCGAG GCGTCTAAATAATTCCAAGG	570	<i>vacA</i> m1	37
VAG-F/ VAG-R	CAATCTGTCCAATCAAGCGAG GCGTCTAAATAATTCCAAGG	645	<i>vacA</i> m2	37
VA4-F/ VA4-R	GGAGCCCCAGGAAACATTG CATAACTAGCGCCTTGACAC	352	<i>vacA</i> m2	39

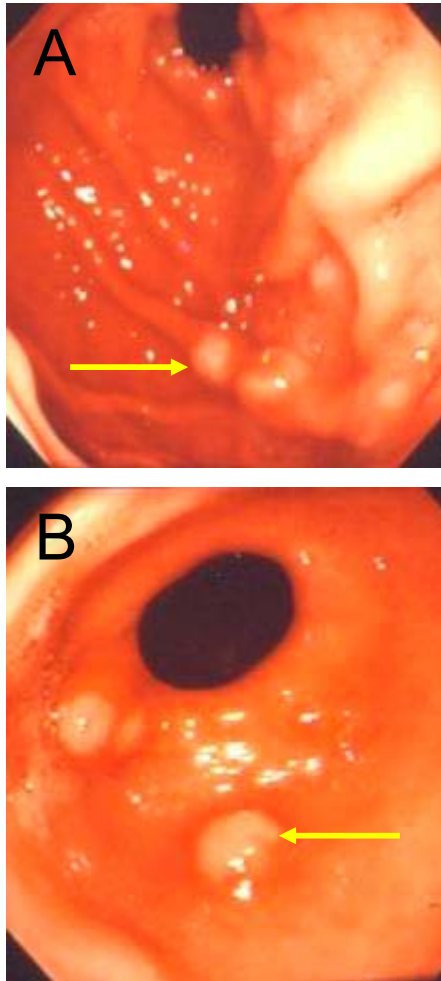
**Note:** for *cagA* EPIYA motif analysis, PCR products were sequenced. VacA activity levels of *vacA* signal and mid-region (s/m) types: s!/m1, high producers; s1/m2, moderate producers; s2/m2, no producers [39,40].

**Figure Legends**

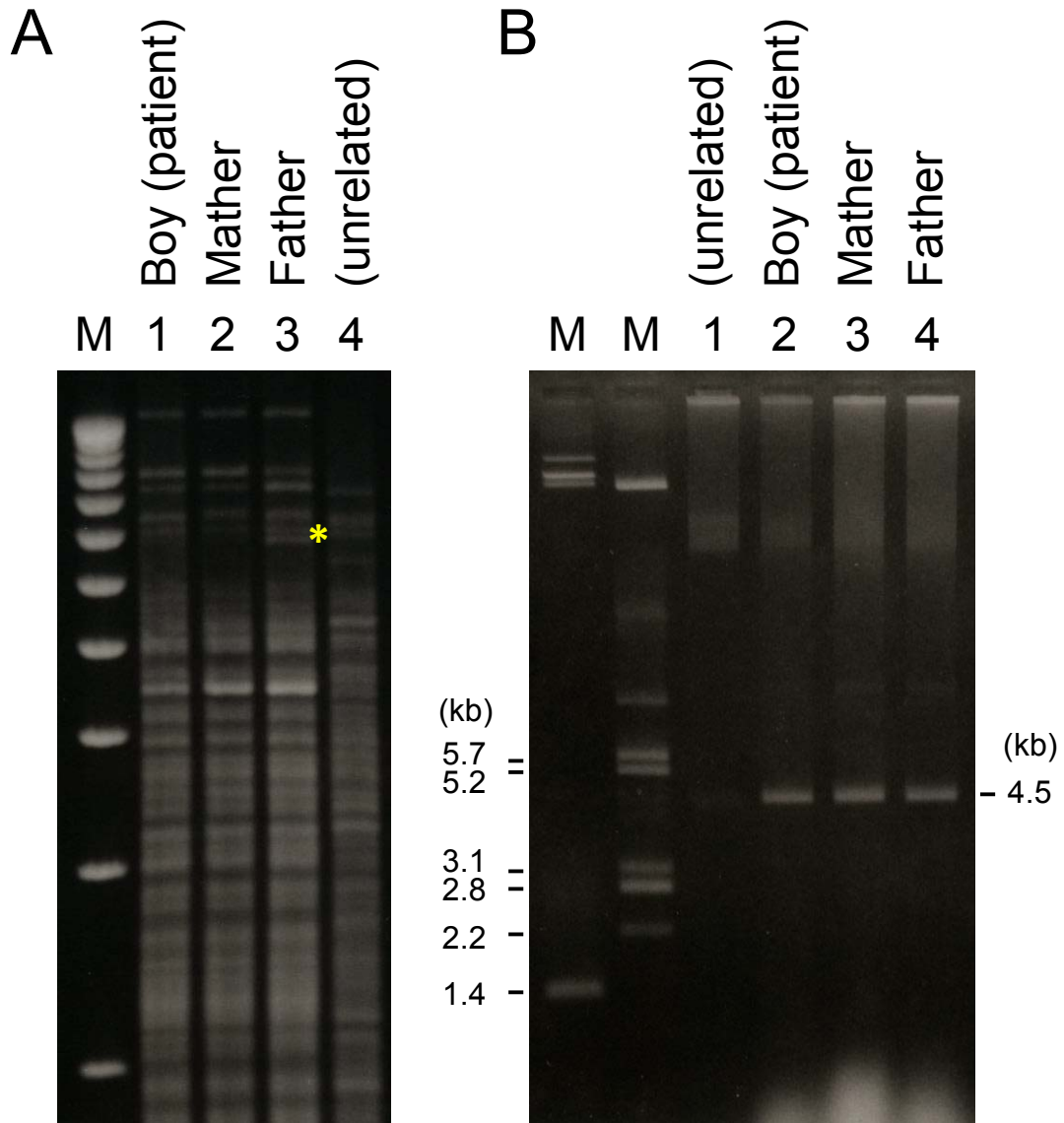
**Figure 1.** Endoscopic images of the gastric body (A), gastric antrum (B), and duodenal bulb (C), and histologic examination of the gastric body (D), gastric antrum (E), and duodenal bulb (F) of a 5-year-old boy with protein-losing gastroenteropathy. The arrow in (A) points to the protein plugs; arrows in D to F point to lymphoid hyperplasia.



**Figure 2.** Endoscopic images of the gastric body (A) and gastric antrum (B) six months after *Helicobacter pylori* eradication therapy. Arrows point to protein plugs.

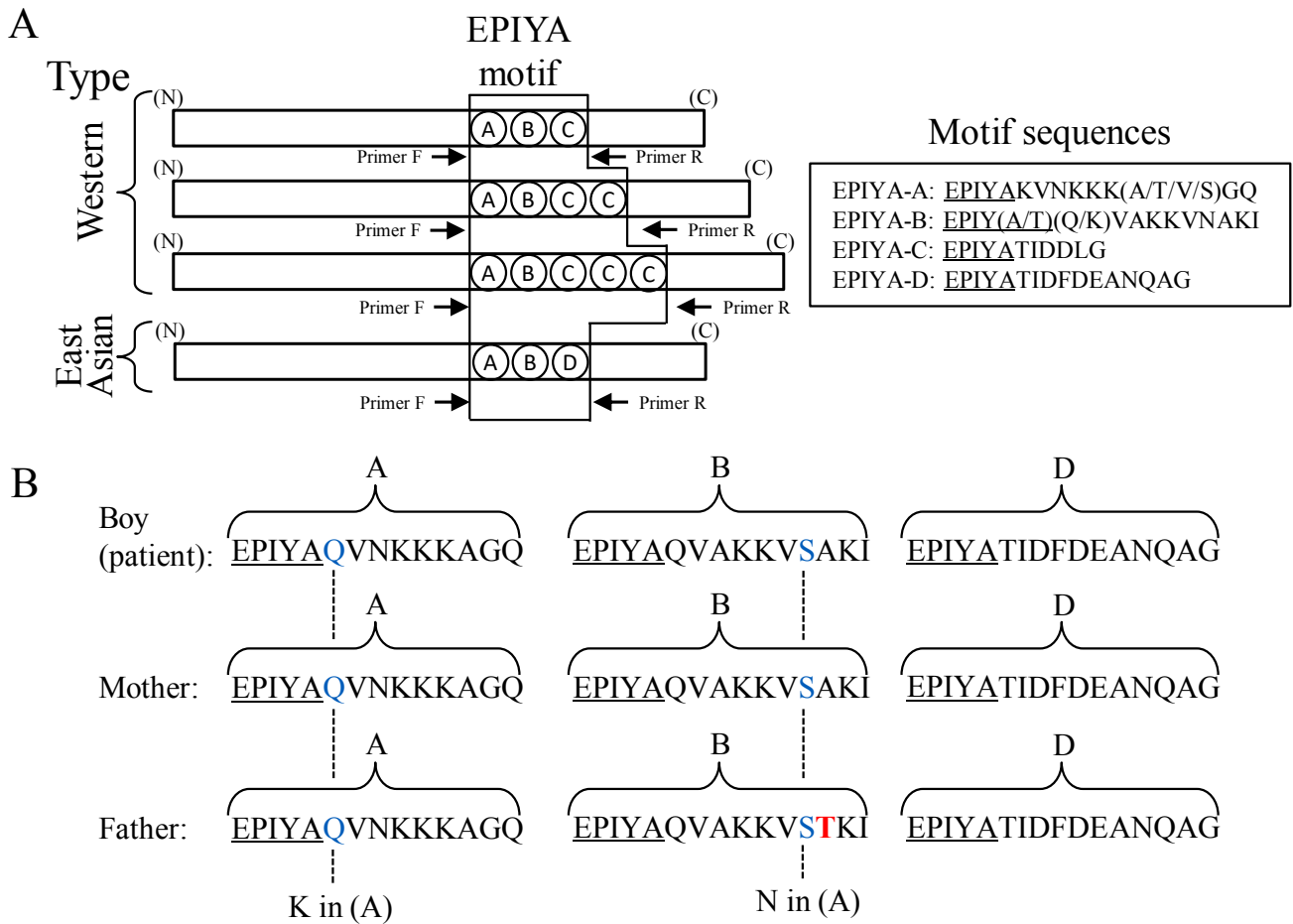


**Figure 3.** Bacterial DNA (A) and plasmid (B) analyses of familial *Helicobacter pylori* strains. In (A), bacterial DNA was digested with *Hind*III; the asterisk indicates a DNA band of the father's digestion pattern divergent from the patient's and mother's digestion patterns. Unrelated, *H. pylori* data from a 5-year-old child unrelated to the patient's family.

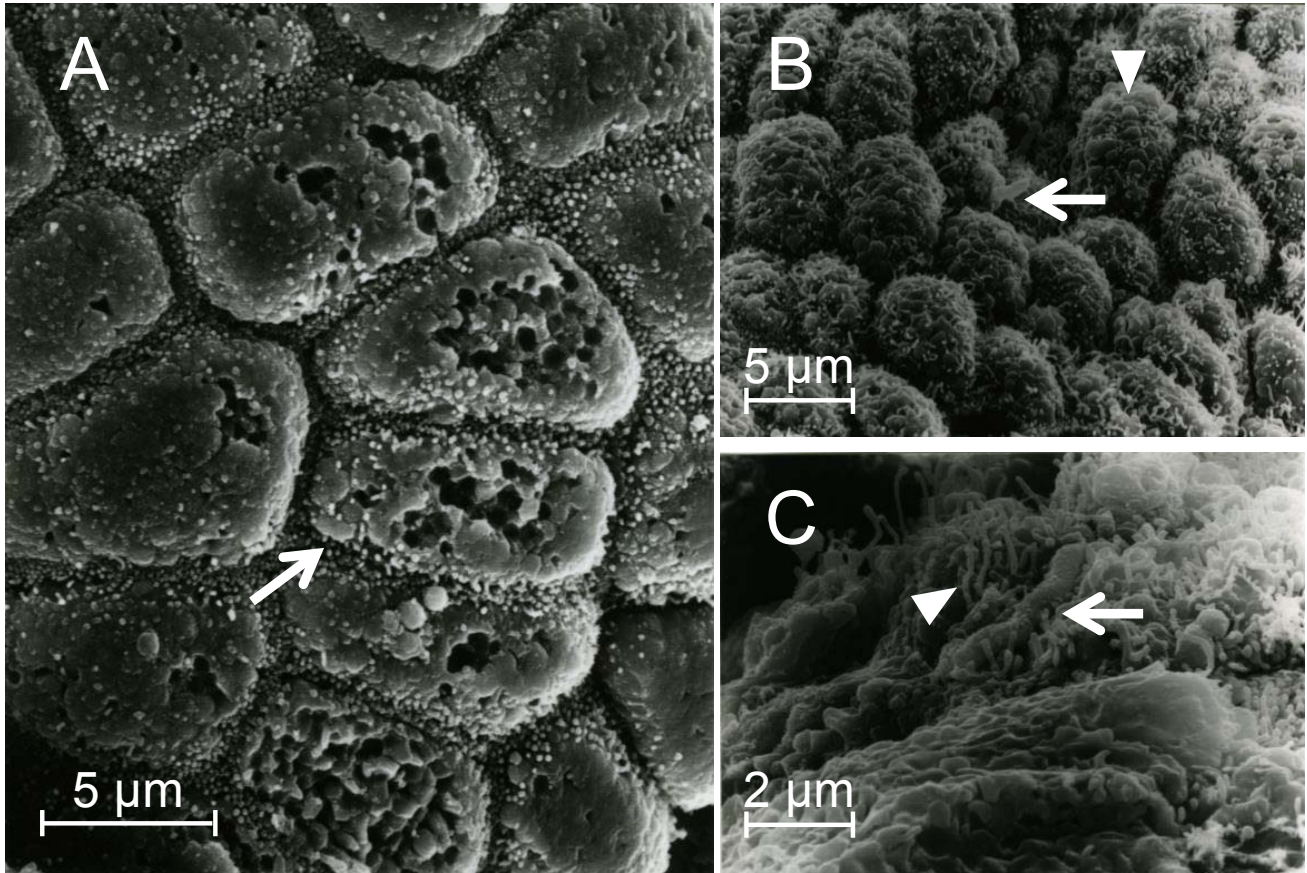




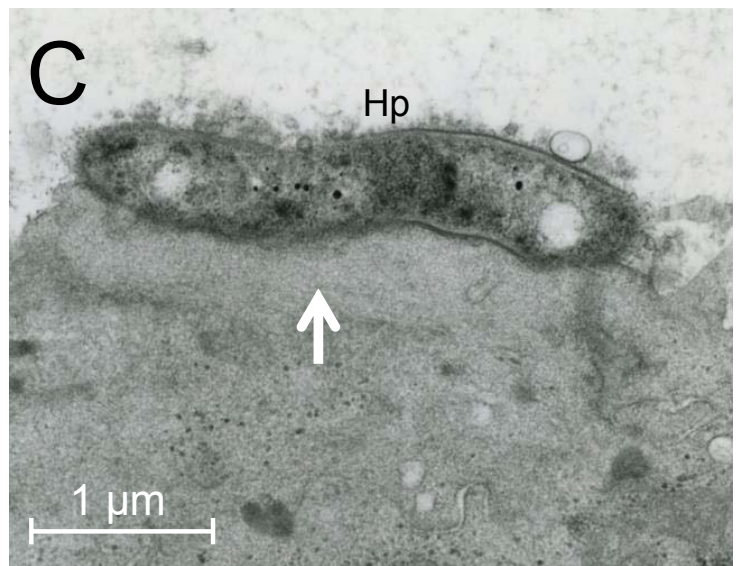
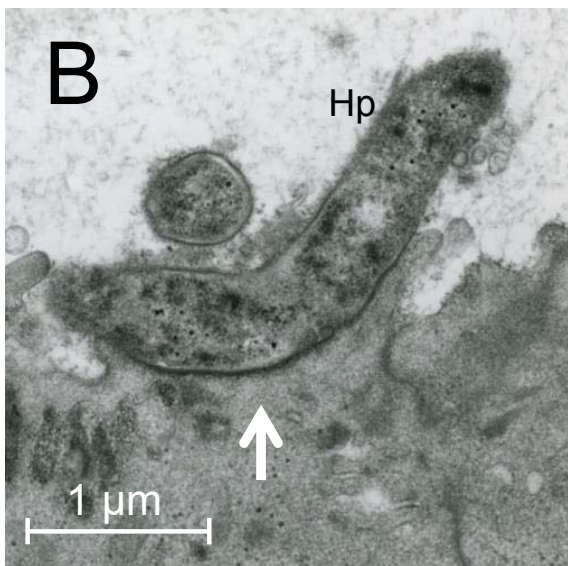
**Figure 4.** CagA protein Glu-Pro-Ile-Tyr-Ala (EPIYA) motif analysis for familial *Helicobacter pylori* strains. (A) The EPIYA motifs of the Western and East Asian types are from reference [17,19]. In (B), the EPIYA motifs of the patient's and parents's *H. pylori cagA* are the same EPIYA-ABD. However, the family's *H. pylori cagA* commonly possessed two divergent amino acid residues (Q in motif A and S in motif B, shown in blue), compared with those shown in (A); and the father's *H. pylori cagA* EPIYA motif was divergent from the patient's and mother's motifs by one amino acid residue (T in motif B, shown in red).



**Figure 5.** Scanning electron micrographs showing the gastric mucosa and *Helicobacter pylori* adherence in the patient with protein-losing gastroenteropathy. (A) An arrow points to a gastric epithelial cell, totally covered with secretions. (B) The arrow points to adherent *H. pylori*; the arrowhead points to an abnormal gastric epithelial cell with small swollen structures at the apical surface. (C) The arrow points to adherent *H. pylori*; the arrowhead points to the unusually irregular and long microvilli of a gastric epithelial cell.

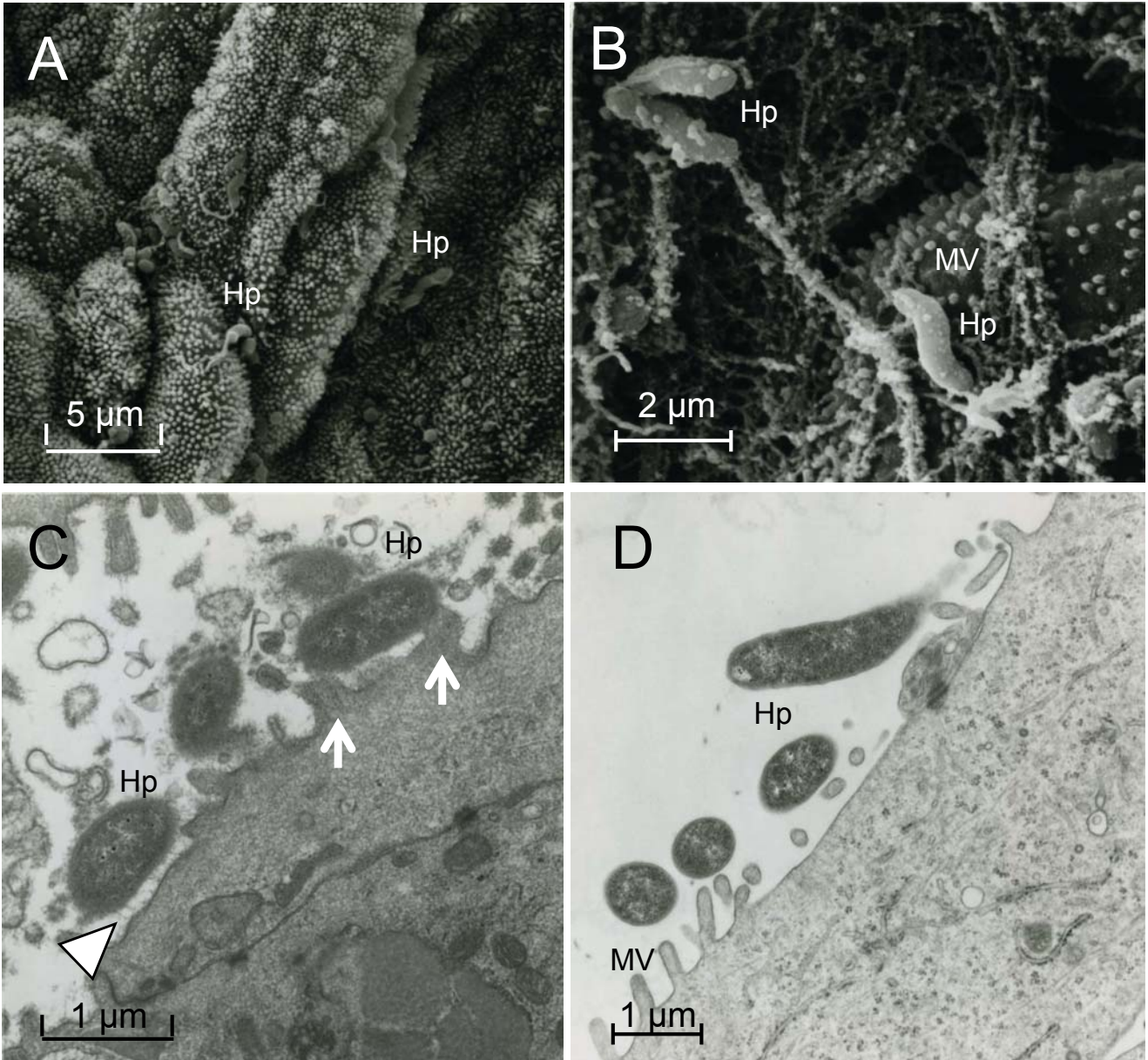


**Figure 6.** Transmission electron micrographs showing *Helicobacter pylori* adherence to the gastric epithelial cells in the patient with protein-losing gastroenteropathy. (A) Two *H. pylori* adhere to gastric epithelial cell, both demonstrating typical pedestal formation. (B) A higher magnification of (A). The arrow points to a thick membranous pedestal, formed along the *H. pylori* body. (C) A higher magnification of (A). The arrow points to a thick membranous pedestal, formed along the whole body of adherent *H. pylori*. (D) *H. pylori* adheres to the microvilli of a gastric epithelial cell. Hp, *H. pylori*; MV, microvilli.

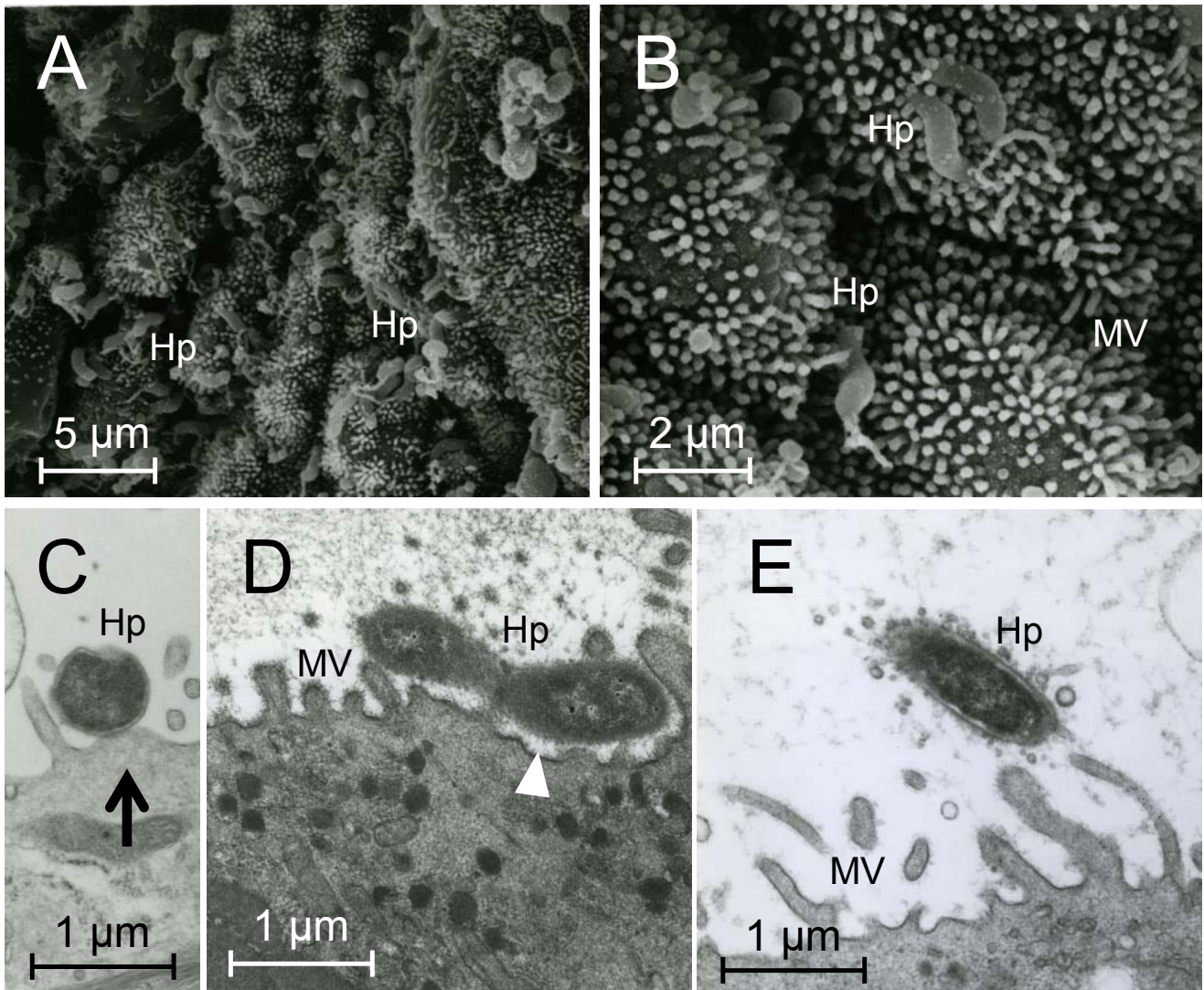




**Figure 7.** Scanning electron (A, B) and transmission electron (C, D) micrographs showing *H. pylori* adherence to a gastric epithelial cell in the mother. (A, B) *H. pylori* adheres to the gastric epithelial cells with the regular and short microvilli. (C) The arrow points to the membranous pedestal attached to a part of the adherent *H. pylori* body (“pedestal-like structure”). *H. pylori* also adheres to a gastric epithelial cell via filaments, as pointed out by the arrowhead. (D) *H. pylori* adheres to the microvilli of a gastric epithelial cell. Hp, *H. pylori*; MV, microvilli.



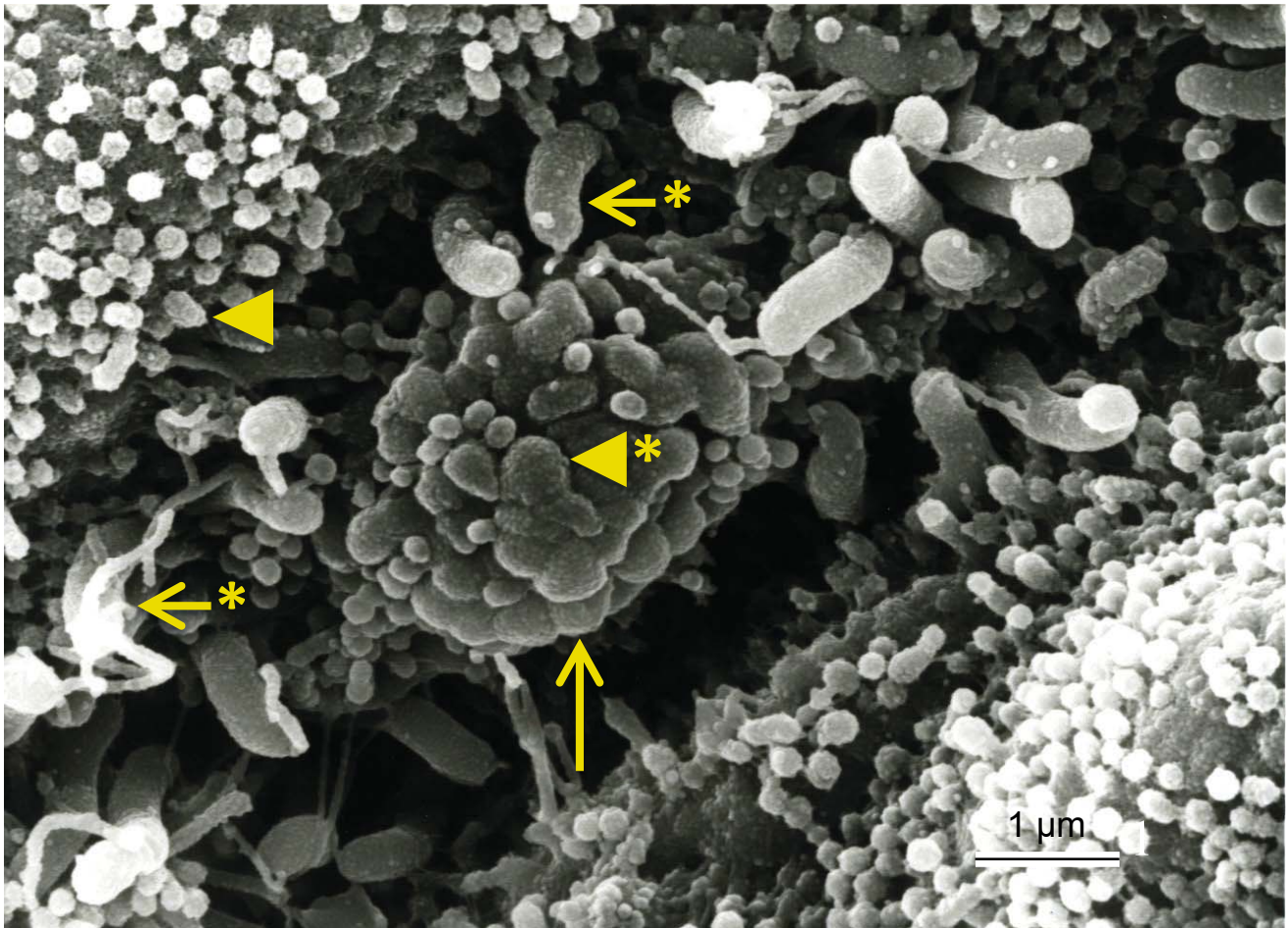
**Figure 8.** Scanning electron (A, B) and transmission electron (C to E) micrographs showing *Helicobacter pylori* adherence to the gastric epithelial cells in the father. (A, B) Numerous *H. pylori* adhere to a gastric epithelial cell with regular and short microvilli. (C) The arrow points to the membranous pedestal attached to a part of the adherent *H. pylori* body ("pedestal-like structure"). (D) *H. pylori* adheres to a gastric epithelial cell via filaments, as pointed out by the arrowhead. (E) *H. pylori* adheres to the microvilli of a gastric epithelial cell. Hp, *H. pylori*; MV, microvilli.





**Supplemental data**

**Fig. S1.** Scanning electron micrograph showing shrinking of a gastric epithelial cell, surrounded and attacked by many “aggressive” or “dancing” *H. pylori*. Each structure is pointed to by symbols: arrow, a shrinking gastric epithelial cell, with attached *H. pylori*; arrow with asterisk; *H. pylori*; arrowhead, the microvilli of a neighboring epithelial cell; arrowhead with asterisk, swollen membranous structures on epithelial cell. *H. pylori* on the left side has flagella.





# PREPARATION OF PATIENTS FOR ELECTIVE PERCUTANEOUS CORONARY INTERVENTION: MANAGEMENT OF RISK FACTORS AS AN APPROACH TO INCREASE IN INTERVENTION EFFICACY

A. Kochergina<sup>1,2</sup>, V. Leonova<sup>1</sup>, N. Kochergin<sup>2</sup>, O. Barbarash<sup>1,2</sup>

<sup>1</sup>Kemerovo State Medical University, Kemerovo, Russia

<sup>2</sup>Federal State Budgetary Scientific Research Institute for Complex Issues of Cardiovascular Diseases, Kemerovo, Russia

## Abstract

The article is a topical literature review of the place of percutaneous coronary interventions in the structure of elective revascularisation procedures, preoperative preparation of patients with stable ischaemic heart disease before percutaneous coronary intervention, the prospects of the technique, taking into account the latest advances in intervention cardiology (intravascular methods for assessing the hemodynamic significance of stenosis, drug eluting stents). Modern data of the early and long-term results of percutaneous coronary intervention are presented, the predictable potentially modifiable risks of adverse events are described, and ways to correct them are discussed. The results of randomised studies comparing the effectiveness of different approaches for managing patients with stable coronary heart disease (medical therapy, percutaneous coronary intervention) are presented, and prospects for using new drugs to improve the early and late outcomes of endovascular revascularisation are discussed.

## Keywords

*stable ischemic heart disease • percutaneous coronary intervention • optimal medical therapy • preparation for percutaneous coronary intervention*

## Introduction

Cardiovascular diseases hold the leading position in the structure of morbidity in employable population. Ischaemic heart disease is a widely spread cardiovascular pathology and optimisation of guidance for such patients is relevant to practical healthcare in the whole world. Development and wide introduction of less invasive coronary artery blood flow restoration methods and elimination of myocardial ischaemia symptoms facilitates maintenance of the patients' quality of life. These methods do not have long-term restoration periods and are associated with fewer postoperative complications in comparison with open surgery.

Percutaneous coronary interventions (PCI) play an important role in the structure of elective revascularisation procedures. The less invasive method of myocardial perfusion restoration significantly improves the quality of life of patients with stable ischaemic heart disease. At the present time, it appears relevant within the framework of practical healthcare to draw attention to high-quality preoperative preparation of patients with stable ischaemic heart disease (IHD) before

PCI. According to literature data, distinct negative influence on development of early and delayed complications after PCI may be exerted by such potentially modifiable factors as arterial blood pressure, the level of lipoproteins, glycaemia, presence of renal dysfunction as well as active smoking and excess body weight. However, a substantial part of patients hospitalised for elective PCI fail to achieve target levels of secondary prevention. According to data from different research, up to one half of patients referred to revascularisation do not receive prescribe treatment including not taking statins. Less than one half of individuals receiving optimal medical therapy reach its goals: persistent arterial blood pressure normalisation, a normal level of lipids, control over the glycaemia level in case of diabetes mellitus. Only a small number of patients with excess body weight demonstrate successful attempts to normalise it, a small part of patients cease smoking.

Efficacy of PCI as well as risk of complications during the procedure are directly associated with the quality of

preoperative preparation of patients. Studying issues of preoperative guidance optimisation for stable IHD patients and development of a method for PCI patient preoperative preparation that would be functional and implementable in routine practice could significantly improve short-term and long-term outcomes of the procedure.

### **The place of elective percutaneous coronary interventions in the structure of revascularisation procedures. Feasibility and prospects of the method**

According to reported data, there was a stable trend toward growth in the total number of PCI performed in the Russian Federation in 2018 [1]. The share of PCI in the structure of revascularisation operations is expected to grow due to increasing revascularisation availability for patients featuring elevated risk associated with open surgery (comorbidities, advanced and senile age).

In stable progression of IHD, persistence of myocardial ischaemia symptoms despite optimal medical therapy (OMT), as well as improvement of the prognosis, is an indication for myocardial revascularisation (PCI of coronary artery bypass grafting (CABG)) [2]. It has been proved in a number of studies that myocardial vascularisation has advantages over OMT in the aspect of angina symptoms severity, the need for antianginals, the increase in physical exercise tolerance (ET) and general improvement of quality of life [3]. Numerous studies devoted to comparison of the two revascularisation methods (PCI and CABG) in regard to frequency of major cardiovascular events and myocardial infarction (MI) development, the necessity for repeat revascularisation leads to two main conclusions [4-11]. The first one lies in the fact that PCI does not provide significant improvement of survivability and decrease in the number of MI during stable IHD progression notwithstanding the type of stents used. The second one lies in the fact that survivability improvement and decrease in the number of MI was demonstrated after CABG. However, the pronouncement of its effect depends on the initial coronary bed lesion severity and, probably, on presence of concomitant diabetes mellitus (DM). In particular, it is recommended for patients with the three-vessel disease and concomitant DM to undergo CABG (evidentiality class I, evidentiality level A) [12], as well as for patients with the coronary bed lesion severity >22 according to the Syntax score (evidentiality class I, evidentiality level A) [12].

Stephan Windecker from Bern hospital notes that myocardial revascularisation is one of the most researched aspects counting over 20 randomised clinical studies comparing open and endovascular approaches, the total number of patients enrolled amounted to over 15,000. Summarising the available

data, it is possible to draw a conclusion that the differences between the two methods regarding the frequency of repeat vascularisation are not eliminated through application of drug-eluting stents (DES) [13]. The SYNTAX score remains the best tool to choose an optimal tactic for patients with multi-vessel disease, stenosis of the left coronary artery (LCA) and DM [12]. Daniel Thuijs presented results of the SYNTAXES study at the TCT congress in autumn 2018. Decadal results of 3/4 patients enrolled in the SYNTAX study available for analysis at this term of observation were evaluated. During the 10 years of observation, the following values were registered in 1301 patients in CABG and PCI groups: overall death-rate: 25.6% vs 29.4%, respectively,  $p = 0.11$ ; in the group with the left main coronary artery lesion: 29.7% vs 31.9%,  $p = 0.43$ ; in the three-vessel disease group, it was 21.9% vs 29.2%,  $p = 0.007$ , especially in high-index SYNTAX patients. In the group of patients with diabetes, lethality amounted to 36.6% after CABG and 39.4% after PCI,  $p = 0.45$  [14]. The presented data suggests that endovascular approach to revascularisation in case of stable IHD may have long-term results comparable to such of the CABG surgery. The latest data make it possible to concern the PCI method as comparable with open myocardial revascularisation for patients with stable IHD in a number of clinical cases given modern technological equipment and objectivation of data with instrumental data.

Despite PCI being a minimally invasive procedure and having lesser perioperative risks in comparison with open cardiac surgery interventions, we must strive to maintain the patient's state as satisfactory as possible not only from the clinical standpoint (chronic heart failure (CHF) compensation) but also in terms of secondary prevention of cardiovascular events (achievement of target arterial blood pressure indicators, lipidogram normalisation) before an elective revascularisation procedure.

Preparation of a patient to elective PCI must include comorbidity correction and evaluation of possible contraindications to the intervention. In daily practice, the latter are erosive-ulcerative lesions in the gastrointestinal tract and, as a consequence, contraindications to undergoing dual antiplatelet therapy. Additionally, renal function assessment (the risk of acute kidney injury due to contrast injection) is given attention.

Patients with indications to myocardial revascularisation have elevated risk of adverse ischaemic events within the period of waiting for the procedure. Thus, according to the meta-analysis data, one patient from eighty dies in three months while being on the CABG "patient list". The optimal waiting time before the operation is a period not exceeding 6 weeks which, in a number of cases (high functional class of angina, LCA lesions, three-vessel disease, systolic dysfunction), must be limited down to 2 weeks [15].

While advantages of PCI over the conservative approach are obvious in case of acute coronary syndrome (ACS),

effects of PCI on the clinical picture of angina and hard end points for patients with stable IHD are widely discussed. Data from the COURAGE study stating that PCI does not have advantages over OMT in relation to decrease in the risk of death, MI and other major cardiovascular events were published for a long time. However, a detailed analysis of the protocol and enrollment criteria makes it clear that it is incorrect to extrapolate these results on all patients [16]. Thus, according to the published results, the participants of the study throughout the whole observation featured target values of arterial blood pressure, lipids and the DM group had the level of glycated haemoglobin at approximately 7%. In other words, the “portfolio” of the study participant was different from patients in daily practice.

Since 2017, the ORBITA (ClinicalTrials.gov Identifier: NCT02062593) study results renewed the discussion regarding feasibility of choosing PCI as a revascularisation method for patient with stable IHD [17, 18]. Scientists from the UK performed a comparison between effects of elected PCI with application of DES and OMT on ET. A total of 230 patients with stable IHD and one-vessel disease with stenosis equal to or over 70% were enrolled into the trial. All participants underwent ET assessment and were randomised into 2 groups: patients in group 1 received PCI with DES while patient in group 2 received “imitation” of intervention. After 6 weeks, all patient underwent repeat ET assessment. It was discovered that there was no difference in terms of ET between the two groups [17, 18]. However, by analogy to the COURAGE study, the data obtained should not be unambiguously interpreted as the advantage of OMT over PCI. ET improvement in patients demonstrated in the ORBITA study against the background of high-quality OMT is to be understood as a reminder about clinical importance of correction for all modifiable cardiovascular risk factors (RF) before elective interventions. Apart from that, personified evaluation of delayed cardiovascular mortality for patients with precursory PCI must promote RF correction programme development, improvement of observation for high-risk patients, the patients’ motivation enhancement and justification of application of more intensive schemes of secondary prevention in the preoperative period and after performance of the intervention [19].

The FAME 2 study aimed at scientific justification for recommendations regarding the PCI performance strategy based upon assessment of the fractional flow reserve (FFR) for all functionally significant stenoses. Among 1220 patients with angiographically significant stenoses, individuals with at least one functionally significant stenosis ( $FFR \leq 0.80$ ) were identified and consequently randomised into a PCI subgroup with FFR+OMT and a subgroup undergoing OMT only. Primary end points of the study were death, MI and the necessity of emergency revascularisation.

The amount of the randomised patients totalled 888 (447 in the PCI group and 441 in the OMT group). The frequency of end points in the PCI group was lower than in the OMT group (13.9% vs 27.0%; risk ratio, 0.46; 95% confidence interval 0.34-0.63;  $p < 0.001$ ) after 5 years of observation.

In general, the study proved that PCI with stenosis functional significance evaluation in the setting of stable IHD have advantage over OMT in terms of deaths, MI, emergency revascularisations in five years of observation [20].

It follows from the aforesaid that the combination of PCI with OMT has the largest clinical and prognostic effects on treatment results. Optimal PCI result may be expected in cases when indications to treatment are objectivised (including application of ischaemia verification methods) and the patient is assigned personalised medication.

### **Modifiable risks before elective PCI: prognostic significance of medical therapy in the period of preoperative preparation**

Patients with indications to myocardial revascularisation, notwithstanding the choice of its method, must receive medical therapy according to recommendations of the European Society of Cardiology due to its confirmed promotion of symptom reduction and prognosis improvement [3]. Procedures aimed at lifestyle change and secondary prevention goals achievement (monitoring of arterial blood pressure (ABP), lipids, glycaemia, smoking cessation, weight normalisation) must begin before revascularisation and continue actively after the intervention [2]. All stable patients with an established IHD diagnosis are indicated for annual control of lipid, blood creatinine and glucose metabolism levels (class 1, level C). Use of aspirin, statins and angiotensin-converting enzyme inhibitors are recommended as medical therapy aimed at prevention of adverse events (class 1, level A).

Lipid exchange impairment is an undisputed factor of cardiovascular risk as well as an irreplaceable predictor of both early and delayed complications. Monitoring of the level of low-density lipoproteins (LDL) plays an important role in decrease of these risks [21]. According to modern guidelines, IHD patients must intake statins (class of recommendations 1, level A) and achieve the target level of LDL [2]. Prescription of statins is a fairly simple, available and at the same time effective way to improve intervention results during the period of the patient’s preparation for revascularisation. It has been shown that statins produce their protective effects not only by lowering the level of lipoproteins but also through their pleiotropic action that includes anti-inflammatory, anti-aggregatory impact, stabilisation of atherosclerotic plaques

and endothelial function improvement [22]. Use of statins before CABG exerted preventive effect on postoperative cognitive dysfunction [23], and safe cognitive status, in turn, facilitated higher adherence to treatment [24]. It has been shown that statin therapy prior to PCI also renders positive effect on the prognosis of patients with stable angina [25].

Protective humoral action of statins in the group of patients with DM type 2 was studied within the framework of the ANDROMEDA study [26]. The results of the study that enrolled 509 patients receiving 10-20mg atorvastatin or 10-20mg rosuvastatin during 16 weeks demonstrated comparable decrease in the level of highly sensitive C-reactive protein despite a more pronounced hypolipidemic effect of rosuvastatin. The COMETS study demonstrated analogical results [27]. The CARDS study [28], within the framework of which the effect of 10mg/day on the combined endpoint including death, nonfatal MI, hospitalisation with progressive angina, repeat revascularisation and brain stroke, showed that patients with DM type 2 had the frequency of adverse events in patients who received statin was 5.8% while that in the placebo group amounted to 9.0% ( $p=0.001$ ) [29].

Effects of statin therapy in the preoperative period for PCI patient has been evaluated in a number of studies. In the ARMYDA study, patients ( $n=153$ ) were randomised into the group with 40mg/day atorvastatin intake and the placebo group 7 days prior to elective PCI. The frequency of perioperative MI was 5% among patients receiving atorvastatin one week prior to PCI and 18% in the placebo group ( $p=0.025$ ) [30]. The NAPLES (Novel Approaches for Preventing or Limiting Events) study, which enrolled 668 patients, had a slightly different design. That study prescribes a higher dosage of atorvastatin – 80mg/day, randomisation was performed one day prior to PCI, the control group continued the earlier-prescribed therapy and the frequency of perioperative MI totalled 9.5% and 15.8%, respectively (risk ratio 0.56; 95% confidence interval: 0.35-0.89;  $p=0.014$ ) [31, 32]. In 2018, a collective of Irish scientists undertook an effort to study effects of postoperative statin therapy with increase dosage (120mg) for achievement of maximum protective effect. The study enrolled 207 patients randomised into 2 subgroups: subgroup A (80mg/12hrs atorvastatin with additional 40mg atorvastatin 2 hours prior to the procedure) and subgroup B (40mg/day atorvastatin in the regular mode). Preparation efficacy was evaluated by the frequency of perioperative MI through measurement of highly sensitive troponin T. As a result, the frequency of perioperative MI amounted to 5.2% in the group of patients receiving 120mg atorvastatin and 10.9% in the group of 40mg atorvastatin intake. However, due to a small sample, no statistical validity was acquired [33].

Simultaneously with the possibility of reliable decrease in perioperative MI, application of statins has nephroprotective effect. Usage of 40mg/12hrs rosuvastatin is associated

with reliably less pronounced increase of serum creatinine and cystatin C within the first day after the contrast X-ray intervention [34-36]. Understanding of cardiorenal interactions makes it possible to conclude that the function of kidneys – or, to be precise, their dysfunction – could be considered as a free-standing factor of cardiovascular risk. PCI as a method guided by injection of X-ray contrast preparations is by itself an acute kidney injury (AKI) risk factor. Contrast injection increases production of endothelin and adenosine which leads to vasoconstriction as well as increase of calcium concentration in cells. Decrease in renal blood flow leads to kidney injury through oxidative stress activation, osmotic nephrosis development in tubules and ischemia in exterior parts of renal medulla. Despite the fact that, in present, the only pathogenetically justified method of AKI prevention and treatment is adequate hydration, a number of authors has been developing ways to decrease AKI risk by means of medical preparations: prescription of 40mg/day rosuvastatin during 7 days prior to and 3 days after elective PCI lead to revealing AKI in only 2 patients (5.88%) and in 12 patients (27%) in the control group,  $p=0.04$ . Within the period of 48 hours after elective PCI, the control group showed growth of creatinine, cystatin C and NGAL, decrease in calculated GFR which pointed to persistence of pathological processes in the renal parenchyma. Therewith, no statistically significant differences in kidney damage markers and calculated GFR were registered in patients who had received high doses of rosuvastatin [37].

Evaluation of individual AKI risk is obligatory (evidentiality class I, evidentiality level C) and it is also recommended for patients medicated with metformin to undergo evaluation of renal function immediately after contrast X-ray intervention (evidentiality class I, evidentiality level C) [3, 19].

Intake of 75-150mg/day aspirin is recommended to all patients with established IHD as it has a proved effect in relation to the prognosis (evidentiality class I, evidentiality level A) [2]. For all stable IHD patients after PCI, dual antiplatelet therapy (DAPT) is recommended. Its duration depends on the risk of haemorrhagic complications. Haemorrhage risk evaluation for patients is possible by means of PRECISE-DAPT and DAPT scales (evidentiality class IIb, evidentiality level A). However, such an approach did not find wide-spread use and, as a consequence, did not acquire a high level of evidentiality [38]. Stable IHD patients may be considered for preliminary clopidogrel prescription, if there is a high probability of consequent PCI (evidentiality class IIb, evidentiality level C) [38]. Clopidogrel prescription (loading dose 600mg, then 75mg/day) against the background of aspirin intake is recommended in case of stable IHD for patients planned for PCI (evidentiality class I, evidentiality level A). Prescription of ticagrelor or prasugrel against the background of aspirin intake may be prescribed instead of clopidogrel to stable IHD

patients with planned PCI provided consideration for ischemic complications (a high SYNTAX score, preceding stent thrombosis, localisation and amount of implanted stents) and potential haemorrhages (evidentiality class IIb, evidentiality level C) [38]. DAPT is not indicated for medically treated patients with stable IHD (without preceding IHD) as well as in case of absent MI in anamnesis [38]. As yet, there is no alternative for clopidogrel in case of patients with stable IHD and undergoing elective PCI [39].

The group of patients hospitalised for future PCI is heterogeneous and includes both patients without preceding MI or revascularisation procedures and patients with post-stroke atherosclerosis. According to the latest guidelines by the European Society of Cardiology regarding treatment of patients after MI with ST segment elevation, prescription of beta-adrenergic blocking agents (BB) is recommended for all patients with reduced ejection fraction (EF) and heart insufficiency symptoms (class of recommendations 1, level A). The recommendations also denote the necessity of BB prescription to less serious patients after primary PCI if there are no contraindications nor symptoms of acute ventricular failure [40, 41].

Angiotensin-converting enzyme inhibitor as well as sartans are recommended for all patients with IHD and such states as arterial hypertension, DM, CHF or chronic kidney disease (class of recommendations 1, level A) [2].

### Arterial hypertension: tight arterial blood pressure control for prognosis optimisation

Arterial hypertension is the most prevalent comorbidity among IHD patients [42]. At that, target ABP values are defined as 140/90mmHg and office systolic ABP target parameters should be 130/90mmHg and lower in patients receiving anti-hypertension medical therapy in case of high tolerability [43]. Within the framework of the SPRINT study, two target ABP levels (<140 and <120mmHg) were compared in over 9000 patients with high cardiovascular risk. However, patients with DM and stroke in anamnesis were excluded from the study. The results showed that more intense ABP decrease (the achieved level of systolic ABP was 121mmHg vs 136mmHg) was associated with decrease in the frequency of main cardiovascular events by 25% and in the overall death rate by 27% [44].

Despite the fact that arterial hypertension tends to be present in 100% IHD patients, and anti-hypertension therapy possesses a wide spectrum of medical preparations and their combinations, it is to be stated that the quality of ABP control remains improper [45]. Target ABP values for patients before elective revascularisation are not designated in current

recommendations. However, a number of works demonstrates that tight control over ABP, including pulse blood pressure, before elective PCI leads to improvement of long-term results of the intervention and the pulse blood pressure index itself may be considered as a predictor for prognostic evaluation [46].

### Active detection of carbohydrate metabolism disorder and their influence of the revascularisation prognosis. Features in revascularisation for patients with carbohydrate metabolism disorder

High prevalence of carbohydrate metabolism disorder (CMD) and the trend toward its increase in the IHD patient population defines growth of attention to this comorbidity. Active detection of CMD in IHD patients could be considered as one of the first stages of effective control over cardiovascular risk before elective revascularisation. In numerous international studies investigating CMD in patients undergoing elective PCI, it has been shown that oral test of glucose tolerance and measurement of HbA1c facilitated additional detection of DM in 16.2% cases, impaired glucose tolerance (IGT) in 24.5% cases and impaired fasting glycaemia in 1% cases [47].

According to the prognosis of the International Diabetes Federation, 642mil people will have DM by 2040. Significant growth of DM prevalence has been registered in the Russian Federation (RF), as well as in all states. According to data from the federal DM registry of the RF, a total of 4.35 million people (3.0% of the population) were subject to regular medical check-up by the end of 2016. Among them, 92% (4 million) had DM type 2, 6% (255 thousand) had DM type 1 and 2% (75 thousand) had other types of DM. However, these data underestimate the real amount of patients as only account for detected and registered cases of the disease. Thus, results of a large-scale Russian epidemiological study (NATION) confirm that only 50% DM type 2 cases are registered [48]. Therefore, the real number of DM in the RF is not less than 8-9 million people (approximately 6% of the population) which is an extreme long-term threat as a significant amount of patients remain undiagnosed and thus do not receive treatment and are at high risk of vascular complication development [49, 50].

Within the framework of the BARI 2D [51], randomised comparison of OMT with revascularisation (both CABG and PCI) for DM patients was carried out. After selection of PCI or CABG as an optimal strategy, the patients were randomised into groups of OMT as a single treatment approach and OMT in combination with revascularisation. After five years, no large differences were found in the combined endpoint:



death, MI or stroke, which were 12% in both OMT and OMT in combination with revascularisation. The CABG group showed a significantly lower frequency of major cardiac or cerebrovascular adverse events (78%) than that in the OMT group (70%,  $p=0.01$ ). However, no difference in survivability was registered (CABG 86%, OMT 84%,  $p=0.33$ ). Neither substantial difference in major adverse events nor survivability were revealed between the OMT group and the PCI group that included patients with predeterminedly less-severe level of IHD than that in the CABG group. Throughout subsequent observation, 38% patients in the OMT group underwent at least one revascularisation due to development of the ischaemic clinical manifestations, while it was 20% for patients in groups of surgical initial treatment. Extrapolating these data on common practice, it is necessary to remember that the results were obtained in a selected population. Thus, the patients were excluded if they required immediate revascularisation or in presence of left main coronary artery stenosis as well as against the background of creatinine  $>177\mu\text{mol/l}$ ,  $\text{HbA1c}>13\%$ , functional classes III-IV of CHF or PCI/CABG in medical history during the preceding 12 months. The risk of major cardiac events in patients with DM and dissatisfactory glycaemic control ( $\text{HbA1c}>7\%$ ) was 2.1 times higher than for individuals without DM (adjusted risk ratio = 2.1, 95% confidence interval: 1.10 to 3.95,  $p=0.02$ ). Despite this, in case of proper glycaemic control ( $\text{HbA1c}\leq 7\%$ ), the risk of adverse events in DM patients does not have significant differences from that for individuals without DM (adjusted risk ratio = 1.33, 95% confidence interval: 0.38 to 4.68,  $p=0.66$ ) [52]. Therefore, the evidence base in relation to influence of modified RF on the prognosis regarding elective myocardial revascularisation is being formed at the present time. Additionally, confirmedly effective means of their modification have been determined.

### **Revealing and correction of modifiable risk factors in patients with stable IHD before elective PCI: the real state of the matter**

It is known that the period of waiting for elective myocardial revascularisation often exceeds the recommended 6 weeks. Despite the importance of control over ABP, lipids and glycaemia levels, smoking cessation and body mass normalisation as confirmed revascularisation result improvement tools, the actual quality of patient preparation is less than ideal in real clinical practice. The issue of suboptimal patient preparation before elective PCI is relevant to hospitals all over the world [45].

A large-scale project EUROASPIRE clearly demonstrates the insufficiency of attention to correction of modifiable RF

in IHD patients even after preceding emergency or elective myocardial revascularisation (CABG/PCI). Analysis of over 16 thousand medical records in 24 European countries including the RF has shown that 93.8% patients received antiplatelet preparations; 82.6% patients received BB; 75.1% patients received angiotensin-converting enzyme inhibitors or sartans; 85.7% patients received statins. At that 16% of the respondents continue active smoking, 59.9% do not maintain a sufficient level of physical exercise, 37.6% have the body mass index of over  $30\text{kg/m}^2$ , 42.7% do not reach the target ABP values ( $140/90\text{mmHg}$ ), 80.5% have the level of LDL cholesterol over  $1.8\text{mmol/l}$ , 26.8% have an established DM diagnosis. Therefore, the fact of adherence to treatment itself cannot be considered a synonym to OMT [45]. The basis of secondary prevention goals achievement is adherence to medical treatment and to recommendations regarding change of life style.

However, among stable IHD patients undergoi9ng elective open revascularisation, only 19% patients received all 4 groups of recommended preparations before CABG (aspirin, statins, BB, angiotensin-converting enzyme inhibitors), 76% had elevated cholesterol levels, only 58% reached target levels of ABP [53].

In addition to initially higher risk of adverse events due to CMD, it has been demonstrated a number of major studies that patients with concomitant CMD fail to achieve correction of RF more often than patients without CMD [51]. Among patients enrolled in the BARI 2D study, high prevalence of smoking, uncontrolled hypertension, hypercholesteremia and combinations of the aforementioned factors [51].

Analogical analysis carried out in Japan has shown that only 18.2% patients had optimal control over the RF investigated in the study (ABP, lipids, glycaemia), at that 51.3% patients reached target ABP levels, 45.7% reached the target lipid profile, 23% demonstrated glycated haemoglobin  $>7\%$  from over 3 thousand patients. During division of the sample into subgroups depending on the presence of DM, it was determined that patients fail to reach target ABP, lipid and glycaemia values significantly more often than individuals without diabetes. Therewith, protective effect of OMT in DM is significantly more pronounced [54]. An analogical picture is seen in hospitals of the Russian Federation. Thus, 30% of 140 patients hospitalised in the SRI for Complex Issues of Cardiovascular Diseases for elective PCI in 2016 had different types of CMD, 88.5% ( $n = 124$ ) had excess body mass with BMI over  $25\text{kg/m}^2$ , the average value of total cholesterol in the subgroup without CMD totalled  $4.5\text{mmol/l}$  and  $4.8\text{mmol/l}$  among patients with CMD [47]. These results demonstrate the necessity for more active work on RF correction for this category of patients.

Another topical issue in actual clinical practice is insufficient and untimely diagnosis of DM on other forms of CMD.



During a retrospective analysis, we showed that CMD was revealed in 23.5% of patients with IHD and indications to elective PCI: 18.5% patients had DM, 5% had IGT, no impaired fasting glycaemia was revealed. Glycaemic status evaluation for IHD patients was carried out according to fasting glycaemia values and upon hospital admission. Active diagnostic search of CMD (glycated haemoglobin measurement, oral glucose tolerance test) was not performed for IHD patients. The majority of DM patients (91.8%) receive sugar-reducing therapy while 100% IGT patients do not undergo non-medication nor pharmacological therapy [55]. Procedures aimed at active diagnosis of CMD performed for the 140 patients admitted to elective PCI revealed 38.6% CMD that had not been diagnosed earlier [47]. Therewith, presence of diabetes defines the strategy of treatment for an important subgroup or patients with multi-vessel disease. In case of combination of multi-vessel disease and DM, the optimal revascularisation strategy is CABG that has significant advantages over PCI in relation to mortality and new MI cases, especially in long-term observation. Consequently, DM not registered before choosing the revascularisation type leads to suboptimal decisions [56].

## Conclusion

Endovascular myocardial revascularisation is a highly technological less traumatic approach to improve the prognosis and the quality of life of IHD patients. Despite the contribution of such factors as smoking dyslipidemia, hypertension and hyperglycaemia into realisation of the unfavourable prognosis during stable IHD has been

convincingly proved, the characteristics of patients admitted for elective PCI demonstrates insufficient carefulness risk correction at the stage of preparation for the surgery. An algorithm of individual patient preparation for PCI effective in the circumstances of actual clinical practice is to be developed. This will make it possible to avoid early and delayed complications and optimise treatment results.

## List of abbreviations

ABP	– arterial blood pressure
BB	– beta-adrenergic blocking agent
IHD	– ischaemic heart disease
MI	– myocardial infarction
CABG	– coronary artery bypass grafting
LCA	– left coronary artery
CMD	– carbohydrate metabolism disorder
OMT	– optimal medical therapy
AKI	– acute kidney injury
DM	– diabetes mellitus
DES	– drug-eluting stent
ET	– exercise tolerance
RF	– risk factor
FFR	– fractional flow reserve
CHF	– chronic heart failure
PCI	– percutaneous coronary interventions

## Conflict of Interest Statement

The authors state that there is no conflict of interest to declare.

## References

1. Petrosyan KV. Report on the scientific and practical work of the Department of X-ray surgical methods for the study and treatment of heart and vascular diseases for 2018. *Byulleten' NTSSSKH im. A.N. Bakuleva RAMN. Serdechno-sosudistyie zabolovaniya*. 2019;20(5):427–33. Russian. <https://doi.org/10.24022/1810-0694-2019-20-5-427-433>
2. Montalescot G, Sechtem U, Achenbach S, Andreotti F, Arden C, Budaj A, et al. 2013 ESC guidelines on the management of stable coronary artery. *Eur Heart J*. 2013;34:2949–3003. <https://doi.org/10.1093/eurheartj/eh296>
3. Neumann FJ, Sousa-Uva M, Ahlsson A, Alfonso F, Banning AP, Benedetto U, et al. 2018 ESC/EACTS Guidelines on myocardial revascularization. *Eur Heart J*. 2019;40(2):87–165. <https://doi.org/10.1093/eurheartj/ehy394>
4. Park SJ, Ahn JM, Kim YH, Park DW, Yun SC, Lee JY, et al. Trial of everolimus-eluting stents or bypass surgery for coronary disease. *N Engl J Med*. 2015;372(13):1204–12. <https://doi.org/10.1056/NEJMoa1415447>
5. Makikallio T, Holm NR, Lindsay M, Spence MS, Erglis A, Menown IB, et al. Percutaneous coronary angioplasty versus coronary artery bypass grafting in treatment of unprotected left main stenosis (NOBLE): a prospective, randomised, open-label, non-inferiority trial. *Lancet*. 2016;388(10061):2743–52. [https://doi.org/10.1016/S0140-6736\(16\)32052-9](https://doi.org/10.1016/S0140-6736(16)32052-9)

6. Ahn JM, Roh JH, Kim YH, Park DW, Yun SC, Lee PH, et al. Randomized trial of stents versus bypass surgery for left main coronary artery disease: 5-year outcomes of the PRECOMBAT study. *J Am Coll Cardiol*. 2015;65(20):2198–206. <https://doi.org/10.1016/j.jacc.2015.03.033>
7. Head SJ, Davierwala PM, Serruys PW, Redwood SR, Colombo A, Mack MJ, et al. Coronary artery bypass grafting vs. percutaneous coronary intervention for patients with threevessel disease: final five-year follow-up of the SYNTAX trial. *Eur Heart J*. 2014;35(40):2821–30. <https://doi.org/10.1093/eurheartj/ehu213>
8. Sipahi I, Akay MH, Dagdelen S, Blitz A, Alhan C. Coronary artery bypass grafting vs percutaneous coronary intervention and long-term mortality and morbidity in multivessel disease: meta-analysis of randomized clinical trials of the arterial grafting and stenting era. *JAMA Intern Med*. 2014;174(2):223–30. <https://doi.org/10.1001/jamainternmed.2013.12844>
9. Stergiopoulos K, Boden WE, Hartigan P, Möbius-Winkler S, Hambrecht R, Hueb W, et al. Percutaneous coronary intervention outcomes in patients with stable obstructive coronary artery disease and myocardial ischemia: a collaborative meta-analysis of contemporary randomized clinical trials. *JAMA Intern Med*. 2014;174(2):232–40. <https://doi.org/10.1001/jamainternmed.2013.12855>
10. Katz MH. Evolving treatment options in coronary artery disease. *JAMA Intern Med*. 2014;174(2):231. <https://doi.org/10.1001/jamainternmed.2013.7492>
11. Rodriguez AE, Fernandez-Pereira C, Mieres J. Coronary artery bypass grafting vs percutaneous coronary intervention in multivessel disease. *JAMA Intern Med*. 2014;174(6):1007. <https://doi.org/10.1001/jamainternmed.2014.776>
12. Neumann FJ, Sousa-Uva M, Ahlsson A, Alfonso F, Banning AP, Benedetto U, et al. The task force on myocardial revascularization of the European Society of Cardiology (ESC) and the European Association for Cardio-Thoracic Surgery (EACTS). *Eur Heart J*. 2019;40(2):87–165. <https://doi.org/10.1093/eurheartj/ehy394>
13. Windecker S, Neumann F-J, Jüni P, Sousa-Uva M, Falk V. Considerations for the choice between coronary artery bypass grafting and percutaneous coronary intervention as revascularization strategies in major categories of patients with stable multivessel coronary artery disease: an accompanying article of the task force of the 2018 ESC/EACTS guidelines on myocardial revascularization. *Eur Heart J*. 2019;40(2):204–12. <https://doi.org/10.1093/eurheartj/ehy532>
14. Protopopov AV, Alekyan BG. New knowledge, new horizons – results of up-to-date research in the field of endovascular treatment of coronary heart disease (by the materials of TCT Congress 2018). *Russ J Endovasc Surg*. 2018;5(4):384–401. Russian. <https://doi.org/10.24183/2409-4080-2018-5-4-384-401>
15. Head SJ, da Costa BR, Beumer B, Stefanini GG, Alfonso F, Clemmensen PM, et al. Adverse events while awaiting myocardial revascularization: a systematic review and meta-analysis. *Eur J Cardiothorac Surg*. 2017;52(2):206–17. <https://doi.org/10.1093/ejcts/ezx115>
16. Windecker S, Stortecky S, Stefanini GG, da Costa BR, Rutjes AW, Di Nisio M, Siletta MG, Maione A, Alfonso F, Clemmensen PM, Collet JP, Cremer J, Falk V, et al. Revascularisation versus medical treatment in patients with stable coronary artery disease: network meta-analysis. *BMJ*. 2014;348:g3859. <https://doi.org/10.1136/bmj.g3859>
17. Boden WE, O'Rourke RA, Teo KK, Hartigan PM, Maron DJ, Kostuk WJ, et al. Optimal medical therapy with or without PCI for stable coronary disease. *N Engl J Med*. 2007;356(15):1503–16. <https://doi.org/10.1056/NEJMoa070829>
18. Al-Lamee R, Thompson D, Dehbi HM, Sen S, Tang K, Davies J, et al. Investigators. Percutaneous coronary intervention in stable angina (ORBITA): A double-blind, randomised controlled trial. *Lancet*. 2018;391(10115):31–40. [https://doi.org/10.1016/S0140-6736\(17\)32714-9](https://doi.org/10.1016/S0140-6736(17)32714-9)
19. Chaitman BR, Mori Brooks M, Fox K, Luscher TF. ORBITA revisited: what it really means and what it does not? *Eur Heart J*. 2018;39(11):963–5. <https://doi.org/10.1093/eurheartj/ehx796>
20. Vershinina EO, Repin AN. Predictors of long-term fatal cardiovascular events after planned percutaneous coronary interventions. *Russ J Cardiol*. 2018;23(11):34–42. Russian. <https://doi.org/10.15829/1560-4071-2018-11-34-42>
21. Xaplanteris P, Fournier S, Pijls NHJ, Fearon WF, Barbato E, Tonino PAL, et al. Five-Year outcomes with PCI guided by fractional flow reserve. *N Engl J Med*. 2018;379(3):250–9. <https://doi.org/10.1056/NEJMoa1803538>
22. Tomilova DI, Karpov YuA, Lopukhova VV. Clinical outcomes of percutaneous coronary intervention with drug eluting stent in stable angina patients. *Russ J Cardiol*. 2017;22(8):7–12. Russian. <https://doi.org/10.15829/1560-4071-2017-8-7-12>
23. Oesterle A, Laufs U, Liao JK. Pleiotropic effects of statins on the cardiovascular system. *Circ Res*. 2017;120(1):229–43. <https://doi.org/10.1161/CIRCRESAHA.116.308537>
24. Argunova YuA, Trubnikova OA, Kagan ES, Barbarash OL. The connection of preoperative adherence to treatment with the risk of development of early postoperative cognitive dysfunction in patients undergone coronary artery bypass grafting. *Russ Cardiol Bull*. 2017;12(2):54–9. Russian.
25. Maleva OV, Trubnikova OA, Kuprijanova TV, Kuhareva IN, Barbarash OL. Adherence to treatment in patients with ischaemic heart disease depending on their cognitive status. *Lechashhij Vrach*. 2017;(10):53. Russian.
26. Betteridge DJ, Gibson JM, Sager PT. Comparison of effectiveness of rosuvastatin versus atorvastatin on the achievement of combined C-reactive protein (<2 mg/L) and low-density lipoprotein cholesterol (<70 mg/dl) targets in patients with type 2 diabetes mellitus (from the ANDROMEDA Study). *Am J Cardiol*. 2007;100(8):1245–8. <https://doi.org/10.1016/j.amjcard.2007.05.044>
27. Stalenhoef AF, Ballantyne CM, Sarti C, Murin J, Tonstad S, Rose H, et al. A Comparative study with rosuvastatin in subjects with

- Metabolic Syndrome: results of the COMETS study. *Eur Heart J*. 2005;26(24):2664–72. <https://doi.org/10.1093/eurheartj/ehi482>
28. Colhoun HM, Betteridge DJ, Durrington PN, Hitman GA, Neil HA, Livingstone SJ, Charlton-Menys V, DeMicco DA, Fuller JH. Effects of atorvastatin on kidney outcomes and cardiovascular disease in patients with diabetes: an analysis from the Collaborative Atorvastatin Diabetes Study (CARDS). *Am J Kidney Dis*. 2009; 54(5):810–9. <https://doi.org/10.1053/j.ajkd.2009.03.022>
  29. Pasceri V, Patti G, Nusca A, Pristipino C, Richichi G, Di Sciacio G. Randomized trial of atorvastatin for reduction of myocardial damage during coronary intervention: results from the ARMYDA (Atorvastatin for Reduction of Myocardial Damage during Angioplasty) study. *Circulation*. 2004;110(6):674–8. <https://doi.org/10.1161/01.CIR.0000137828.06205.87>
  30. Gogolashvili NG. Atorvastatin – 20 years in the struggle for life. *Russ J Cardiol*. 2018;23(2):134–49. Russian. <https://doi.org/10.15829/1560-4071-2018-2-134-149>
  31. Briguori C, Visconti G, Focaccio A, Donahue M, Golia B, Sveltella L, Ricciardelli B. Novel approaches for preventing or limiting events (Naples) III trial: randomized comparison of bivalirudin versus unfractionated heparin in patients at increased risk of bleeding undergoing transfemoral elective coronary stenting. *JACC Cardiovasc Interv*. 2015;8(3):414–23. <https://doi.org/10.1016/j.jcin.2014.10.015>
  32. Pourhosseini H, Lashkaria R, Aminorroayaa A, Soltania D, Jalalia A, Tajdini M. Effects of high dose atorvastatin before elective percutaneous coronary intervention on highly sensitive troponin T and one year major cardiovascular events; a randomized clinical trial. *Int J Cardiol Heart Vasc*. 2019;22:96–101. <https://doi.org/10.1016/j.ijcha.2018.12.003>
  33. Vershinina EO, Repin AN, Udut VV, Timofeev MS. Prevention of periprocedural kidney injury by loading doses of statins in elective percutaneous coronary interventions. *Kardiologiya*. 2018;58(S5):20–9. Russian. <https://doi.org/10.18087/cardio.2459>
  34. Vershinina EO, Repin AN. Contrast-induced nephropathy after elective percutaneous coronary interventions. *Sib Med Zhurn (t. Tomsk)*. 2016;31(3):61–7. Russian.
  35. Wang XL, Zhang T, Hu LH, Sun SQ, Zhang WF, Sun Z, et al. Comparison of effects of different statins on contrast-induced acute kidney injury in rats: histopathological and biochemical findings. *Oxid Med Cell Longev*. 2017;2017: 1–10. <https://doi.org/10.1155/2017/6282486>
  36. Pristrom AM, Pyrochkin AV, Chernogla PF, Borisenko TD, Gavrosh TS, Dechko SV, et al. Rosuvastatin (mertenil®) in prevention of contrast-induced nephropathy in elective percutaneous coronary intervention. *Meditinskije novosti*. 2016;(1):27–32. Russian.
  37. 2017 ESC Focused update on dual antiplatelet therapy in coronary artery disease developed in collaboration with EACTS. *Russ J Cardiol*. 2018;23(8):113–63. <https://doi.org/10.15829/1560-4071-2018-8-113-163>. Russian.
  38. Panchenko EP. Have we shifted our paradigm of clopidogrel as a mandatory drug in treatment of cardiological patients after the introduction of more powerful antiagregants? *Atherothrombosis*. 2017;(2):32–42. Russian. <https://doi.org/10.21518/2307-1109-2017-2-32-42>
  39. 2017 ESC guidelines for the management of acute myocardial infarction in patients presenting with ST-segment elevation. *Russ J Cardiol*. 2018;23(5):103–158. Russian. <https://doi.org/10.15829/1560-4071-2018-5-103-158>
  40. Symposium “Topical issues of beta-blocker application in clinical practice: is everything known to a practicing therapist?”. *Russ Med Zhurn*. 2017;25(25): 1841–45.
  41. Sumin AN, Korok EV, Shcheglova AV, Barbarash OL. Comorbidities in patients with ischemic heart disease: gender differences. *Rational Pharmacotherapy in Cardiology*. 2017;13(5):622–9. Russian. <https://doi.org/10.20996/1819-6446-2017-13-5-622-629>
  42. Williams B, Mancia G, Spiering W, Agabiti Rosei E, Azizi M, Burnier M, et al. 2018 ESC/ESH Guidelines for the management of arterial hypertension The Task Force for the management of arterial hypertension of the European Society of Cardiology (ESC) and the European Society of Hypertension (ESH). *J Hypertens*. 2018;36(10):1953–2041. <https://doi.org/10.1097/HJH.0000000000001940>
  43. Wright JT, Williamson JD, Whelton PK, Snyder JK, Sink KM, Rocco MV, et al. A randomized trial of intensive versus standard blood-pressure control. *N Engl J Med*. 2015;373(22):2103–16. <https://doi.org/10.1056/NEJMoa1511939>
  44. Kotseva K, De Backer G, De Bacquer D, Rydén L, Hoes A, Grobbee D, et al. Lifestyle and impact on cardiovascular risk factor control in coronary patients across 27 countries: Results from the European Society of Cardiology ESC-EORP EUROASPIRE V registry. *Eur J Prev Cardiol*. 2019;26(8):824–35. <https://doi.org/10.1177/2047487318825350>
  45. Warren J, Nanayakkara S, Andrianopoulos N, Brennan A, Dinh D, Yudi M, et al. Impact of pre-procedural blood pressure on long-term outcomes following percutaneous coronary intervention. *J Am Coll Cardiol*. 2019;73(22):2846–55. <https://doi.org/10.1016/j.jacc.2019.03.493>
  46. Ignatova YS, Karetnikova VN, Kochergina AM, Gruzdeva OV, Khorlampenko AA, Barbarash OL. Diagnosis and correction of carbohydrate metabolism disorders before elective transcatheter coronary intervention in conditions of real-life clinical practice. *Serdce*. 2017;16(4):253–9. Russian. <https://doi.org/10.18087/rhj.2017.4.2365>
  47. Dedov II, Shestakova MV, Galstyan G.R. The prevalence of type 2 diabetes mellitus in the adult population of Russia (NATION study). *Diabetes Mellitus*. 2016;19(2):104-12. Russian. <https://doi.org/10.14341/DM2004116-17>
  48. Dedov II, Shestakova MV, Mayorov AY, Vikulova OK, Galstyan GR, Kuraeva TL, et al. 8th edition. Standards of specialized diabetes care. Edited by Dedov II, Shestakova MV, Mayorov AY. 8th edition. *Diabetes Mellitus*. 2017;18(1S):1–112. Russian. <https://doi.org/10.14341/dm20151s1-112>

49. ESC guidelines on diabetes, pre-diabetes, and cardiovascular diseases developed in collaboration with the EASD. *Russian Journal of Cardiology*. 2014;19(3):7–61. Russian.
50. Golukhova EZ, Kuznetsova EV. Myocardial revascularization in patients with type 2 diabetes mellitus: An overview of modern techniques. *Diabetes Mellitus*. 2016;19(5):406–13. Russian. <https://doi.org/10.14341/DM8031>
51. Baseline characteristics of patients with diabetes and coronary artery disease enrolled in the Bypass Angioplasty Revascularization Investigation 2 Diabetes (BARI 2D) trial. *Am Heart J*. 2008;156(3):528–36. <https://doi.org/10.1016/j.ahj.2008.05.015>
52. Kassaian SE, Goodarzynejad H, Boroumand MA, Salarifar M, Masoudkabar F, Mohajeri-Tehrani MR, et al. Glycosylated hemoglobin (HbA1c) levels and clinical outcomes in diabetic patients following coronary artery stenting. *Cardiovasc Diabetol*. 2012;11:82. <https://doi.org/10.1186/1475-2840-11-82>
53. Pomeskina SA, Borovik IV, Krupyanko EV, Zavirilina IN, Barbarash OL. Compliance with drug therapy in patients with coronary artery disease undergoing coronary artery bypass grafting. *Sib Med Zhurn (t. Tomsk)*. 2013;28(4):71–6. Russian.
54. Iijima R, Nakamura M, Matsuyama Y, Muramatsu T, Yokoi H, Hara H, et al. Effect of optimal medical therapy before procedures on outcomes in coronary patients treated with drug-eluting stents. *Am J Cardiol*. 2016;118(6):790–6. <https://doi.org/10.1016/j.amjcard.2016.06.050>
55. Ignatova YuS, Karetnikova VN, Kochergina AM, Gruzdeva OV, Khorlampenko AA, Zagorodnikov NI, et al. Diagnostic value of markers of carbohydrate metabolism disorders in patients with coronary artery disease before planned percutaneous coronary intervention. *Creat Cardiol*. 2018;12(3):211–24. Russian. <https://doi.org/10.24022/1997-3187-2018-12-3-211-224>
56. Korotin AS, Posnenkova OM, Kiselev AR, Popova YV, Gridnev VI. Coronary artery stenosis: is revascularization always reasonable? *Complex Issues Cardiovasc Dis*. 2019;8(1):42–51. Russian. <https://doi.org/10.17802/2306-1278-2019-8-1-42-51>

# PRIMARY ALDOSTERONISM COMPLICATED BY HYPOKALEMIC RHABDOMYOLYSIS. A CLINICAL CASE

K. Skaletsky<sup>1</sup>, E. Kosmacheva<sup>1,2</sup>, N. Kizhvatova<sup>1,2</sup>, V. Porhanov<sup>1,2</sup>

<sup>1</sup>Scientific Research Institution – Regional Clinical Hospital No.1 n.a. S.V. Ochapovsky, Krasnodar, Russian Federation

<sup>2</sup>Kuban State Medical University, Krasnodar, Russian Federation

## Abstract

Primary aldosteronism (PA) is one of the most common causes of secondary hypertension, which in less than half of cases is manifested by hypokalemia. In cases where hypokalemia becomes significant, it can lead to muscle weakness or even paralysis. Such patients are often unsuccessfully treated by neurologists or rheumatologists. In our clinical case a 61 year old patient had rapidly developing symptoms, which were interpreted by ambulance paramedics as an acute cerebrovascular accident. Since the patient was admitted to a multidisciplinary hospital, he was examined by doctors of different specialties, the diagnostic direction was set correctly and rhabdomyolysis was already detected at the initial stage. We excluded various causes of myopathy, which ultimately led us to the most likely cause of this condition - hypokalemia, and explained muscle symptoms. As a result, it helped us to identify the correct diagnosis - aldosteronism. The patient quickly recovered due to the prescribed therapy and felt good, and therefore refused surgical treatment (adrenalectomy), which, perhaps, would allow him to fully recover. Thus, a rare clinical case of differential diagnosis and successful drug treatment of PA with hypokalemia, which is manifested by rhabdomyolysis, is presented.

## Keywords

primary aldosteronism • hypokalemia • rhabdomyolysis • arterial hypertension

## Introduction

Primary aldosteronism (PA) (Conn's syndrome) is a clinical syndrome caused by excess aldosterone production by zona glomerulosa of the adrenal cortex, which leads to low renin hypertension [1].

PA is the most common reason of high blood pressure among all secondary hypertension and, according to various sources, occurs from 6% in the general population of patients with arterial hypertension to 20% among patients with uncontrolled arterial hypertension [2-5].

Excess aldosterone leads to development of hypernatremia, hypokalemia and metabolic alkalosis. This determines the manifestation of three main clinical syndromes of PA, among which the most constant is arterial hypertension (in 98% of cases) as well as nephro- (50-70%) and myopathy (38-75%). Hypokalemia (less than 3,5 mmol/L), previously considered a mandatory PA symptom, is found in 30-40% of patients with this pathology and likely observed in the most severe cases, according to modern concepts [6-8].

Hypokalemia-associated myopathy manifests mainly in the form of muscle weakness, however, in rare cases it may

result in rhabdomyolysis, as previously reported in a few publications mainly in foreign literature [9-14].

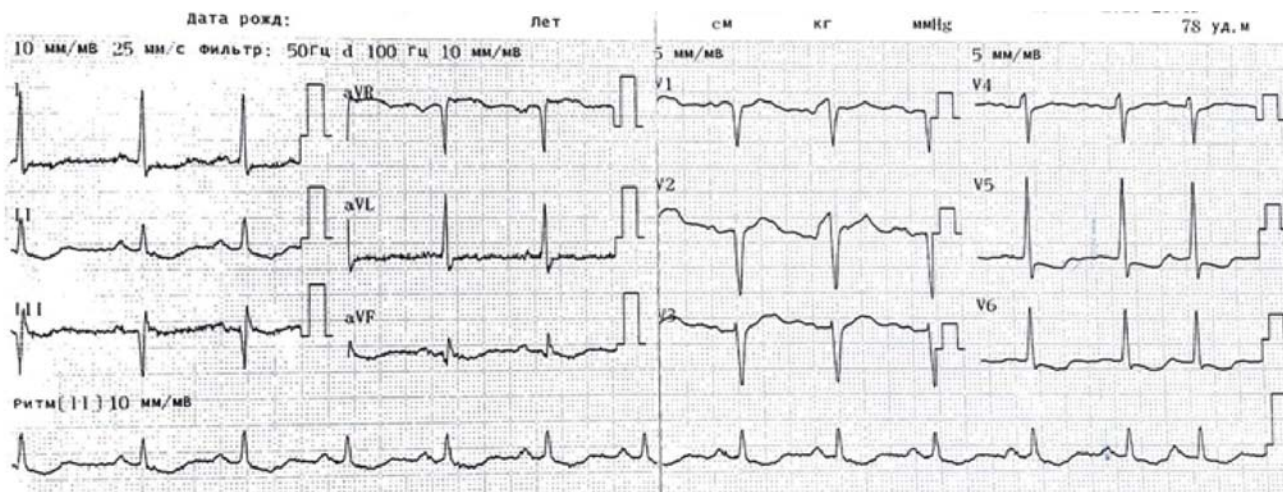
In view of this, patients can be observed by a neurologist or rheumatologist for a long time before they get the attention of a cardiologist or endocrinologist. The presented clinical case demonstrates the manifestation of PA in the form of hypokalemic rhabdomyolysis.

## The clinical case

A 61 year old male was transported by an ambulance team to the hospital with a suspected acute cerebrovascular accident (CVA) with complaints on restriction of movement and weakness in the upper and lower limbs, dizziness and headache.

The patient was examined by a neurologist, and underwent computed tomography (CT) scan of the head, no focal brain ischemia was detected. In the neurological status, the





**Figure 1.** Electrocardiogram upon admission to the hospital (chest leads voltage 5 mm / mv)

absence of focal symptoms was noteworthy and limitation of limb movement was caused by severe pain in muscles.

The patient had a long history of arterial hypertension with a maximum increase in ABP to 220/120mmHg, and the usual ABP of 170/105mmHg, the three-component background therapy consisted of perindopril arginine 10mg, indapamide 2.5mg and bisoprolol 10mg. The patient had been noticing muscle weakness for several weeks, but he only noted the appearance of pain in the limbs with a gradual progression up to the inability to climb several stair steps three days before seeking medical help.

The admission electrocardiogram (ECG) revealed changes in repolarisation in the form of ST segment depression up to 2 mm in inferior leads, and the presence of a U-wave (Figure 1). In laboratory analysis hypokalemia of 2.08mmol/l, a pronounced increase in creatine phosphokinase (CPK) up to 11307U/l, increased transaminases, proteinuria, and very alkaline urine (detailed laboratory data is presented in Table 1). The patient was consulted by a rheumatologist about myopathic syndrome, dermatomyositis was suspected, however, an immunoblot test did not reveal any autoantibodies. Further diagnostic research included the following most common causes of rhabdomyolysis: direct injuries of striated muscles, prolonged intense exercise, neuromuscular diseases, toxic effects (alcohol, several medicines, snake poison, etc.), infections, hyperthermia and hypokalaemia.

With a detailed history taking and additional instrumental examination, all of these conditions were sequentially excluded, except for persistently preserved hypokalaemia at a level of 2.0-2.5mmol/l despite active infusion therapy with potassium. Given the long history of uncontrolled hypertension, hypokalaemia, myopathic syndrome, kidney damage and urinary alkalosis, hyperaldosteronism was suspected.

A blood test for renin and aldosterone revealed high plasma concentration of aldosterone (32.8ng/dl) with the background of a pronounced suppression of renin secretion (0.006ng/dl), which, according to the updated international recommendations of the Endocrine Society (2016) [6], is a sufficient criterion for establishing PA as a diagnosis without determining the aldosterone/renin ratio and conducting confirmatory tests.

According to the algorithm, the next step is topical diagnosis, for which the patient underwent adrenal CT with contrast. Masses of both adrenal glands of approximately the same density were revealed: sized 13x17mm in the lateral branch of the left adrenal gland (Figure 2) and 12x9mm in the body of the right adrenal gland (Figure 3). During the ongoing background therapy aimed at compensating for the loss of potassium, the patient noted a significant improvement in well-being due to the disappearance of muscle symptoms, so he refused surgery. Based on this, comparative selective adrenal vein sampling (AVS) was not done, since it would not change the tactics of medical treatment.

Spirololactone was titrated up to 300 mg per day for the patient in combination with perindopril and bisoprolol. Against this background, the maximum level of potassium during the hospitalisation was 3.1mmol/l. The concentration of CPK gradually decreased. The average blood pressure before discharge was 135-140/80mmHg. Signs of severe hypokalaemia on the ECG were levelled (Figure 4).

The final diagnosis was stated as follows: "Secondary arterial hypertension (primary aldosteronism complicated by hypokalemic rhabdomyolysis)". Unfortunately, the connection with the patient was lost after discharge and the long-term results of treatment remain unknown.



**Table 1.** Laboratory analysis of the patient.

Parameter	Value	Reference values
Renin	0.006 ng / dl	(3.30-31.71)
Aldosterone	Aldosterone 32.83 ng / dL	---
High-sensitivity troponin	0.90 ng / ml	(0.00-0.04)
Creatine kinase	11307.00 U / L	(29.00-200.00)
Creatine Kinase-MB	176.10 U / L	(0.00-24.00)
Glucose	11.40 mmol / L	(3.50-6.38)
Urea	7.80 mmol / L	(1.70-8.30)
Creatinine	130.30 $\mu$ mol / L	(62.00-115.00)
Sodium	146.66 mmol / L	(136.00-145.00)
Potassium	2.08 mmol / L	(3.50-5.10)
Chlorides	96.71 mmol / L	(98.00-110.00)
Total calcium	2.20 mmol / L	(2.10-2.55)
Inorganic phosphorus	1.11 mmol / L	(0.74-1.20)
Magnesium	0.93 mmol / L	(0.85-1.15)
Total bilirubin	24.30 $\mu$ mol /L	(3.40-20.50)
Total protein	72.06 g / L	(64.00-83.00)
Aspartate aminotransferase	308.00 U / L	(5.00-35.00)
Alanine aminotransferase	95.00 U / L	(0.00-55.00)
Parathyroid hormone	6.30 pMol / L	(1.50-7.60)
PSA	1.81 ng / ml	(0.00-4.00)
White blood cells	8.88 10e9 /L	(4.00-9.00)
Red blood cells	4.99 10e12 / L	(3.100-5.700)
Hemoglobin	155.00 g /L	(122.00-168.00)
Hematocrit	47.90%	(40.00-48.00)
Platelets	413.00 10e9 / L	(150.00-400.00)
Relative urine density	1.010	(1.012-1.025)
Urine PH	8.0	(4.0-7.0)
Protein in the urine	1.0 g / L	(0-0.03)
Calcium in the urine per day	2.80 mmol / day	(2.50-6.20)



**Figure 2.** Mass in the left adrenal gland



**Figure 3.** Mass in the right adrenal gland

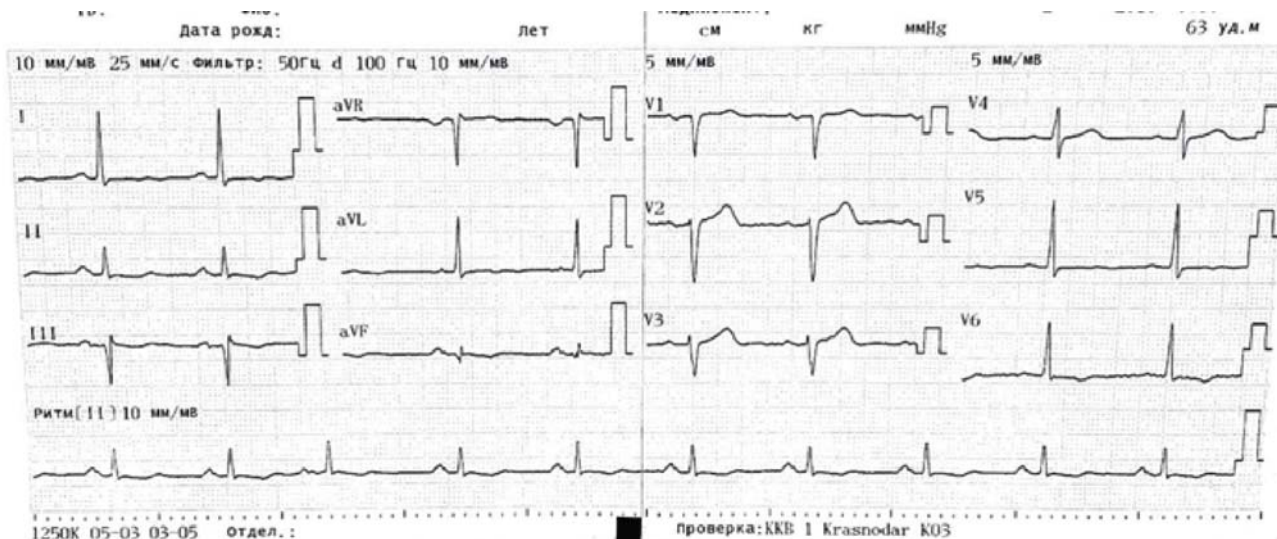


Figure 4. Electrocardiogram before discharge (chest leads voltage 5mm/mv)

## Discussion

In most cases, PA is manifested by non-specific symptoms, and therefore it is often at the junction of various specialties and may remain undetected for a long time. Even hypokalaemia is not always alarming for doctors, although it can be the key to the diagnosis. In our case, we described a rare situation when rhabdomyolysis was the leading symptom of PA. Therefore, we consider it important to screen patients with a combination of hypokalaemia and other unexplained causes of rhabdomyolysis for PA.

The mechanism of rhabdomyolysis with hypokalaemia remains debatable, but in general it has quite convincing pathophysiological justifications. According to one theory, hypokalaemia leads to dysfunction of the sodium-potassium pump, which causes an increase in cellular permeability to sodium, and the launch of a compensatory sodium-calcium pump. As a result, excess intracellular calcium activates proteolytic enzymes that destroy myocytes [15].

According to another theory, hypokalaemia contributes to inadequate vasodilation of arterioles and capillaries in the muscles with an increased exercise and a decrease in blood flow, which leads to ischemia and necrosis of muscle cells [14, 16].

The absence of hyperkalaemia and acute renal failure in this situation, intrinsic to traumatic rhabdomyolysis, is probably caused by permanent increased excretion of potassium and the slow process of destruction of myocytes.

Due to the fact that the diagnostic research was completed without performing AVS, the PA subtype remained unclassified by us and it is unclear whether both masses are hormonally

active. Unfortunately, CT has a number of limitations: small aldosteromas can be interpreted as diffuse hyperplasia with bilateral or multiple nodular lesions or not be detected at all due to the small size, and "obvious" microadenomas may turn out to be areas of focal hyperplasia and a diagnostic error in this case leads to unreasonable unilateral adrenalectomy [6]. The CT results often do not correspond to the lateralization of aldosterone production in AVS. There are described cases when the aldosteroma assumed by the CT results turned out to be a hormonally inactive adenoma, in contrast to the contralateral "unchanged" adrenal gland [17].

The capabilities of  $^{11}\text{C}$ -metomidate positron emission tomography-CT (PET-CT) allow lateralisation with comparable sensitivity and specificity without resorting to invasive AVS, which is often uninformative due to the technical complexity of this manipulation [18].

However, PET-CT remains an inaccessible diagnostic method due to its high cost. Genetic typing of subtypes and sporadic forms of PA is also practically inaccessible, and the clinical value of determining such mutations remains unclear [8].

In the case of choosing a medical treatment strategy, the patient should be prescribed the minimum effective dose of spironolactone to reduce the risk of side effects, antiandrogenic activity in particular. Certainly, our patient needed to continue titration of the dosage of spironolactone. However, due to the loss of contact, it was not possible to track down. Better informing of specialists (cardiologists, family physicians, neurologists, rheumatologists, endocrinologists) about the features of this nosology should help ensure that

outpatient care of such patients is as effective and safe as possible.

## Conclusion

This clinical example reports a rare manifestation of primary aldosteronism in the form of rhabdomyolysis. The correct diagnosis, established according to the modern algorithm, will

successfully treat arterial hypertension and muscle symptoms in such patients, thereby improving both the quality of life and, probably, the prognosis.

## Conflict of Interest Statement

The authors declare no conflict of interest.

## References

1. Beltsevich DG. Primary aldosteronism. Clinical recommendations. *Endocrine Surgery*. 2008;2:6–20. Russian
2. Carey R. Diagnosing and Managing Primary Aldosteronism in Hypertensive Patients: a Case-Based Approach. *Curr Cardiol Rep*. 2016;18(10):97. <https://doi.org/10.1007/s11886-016-0774-1>
3. Buffolo F, Monticone S, Burrello J, Tetti M, Veglio F, Williams TA et al. Is primary aldosteronism still largely unrecognized? *Horm Metab Res*. 2017; 49(12):908–14. <https://doi.org/10.1055/s-0043-119755>
4. Reincke M. Primary Aldosteronism and Cardiovascular Events : It Is Time to Take Guideline Recommendations Seriously. *Hypertension*. 2018;71(3):413–14. <https://doi.org/10.1161/hypertensionaha.117.10405>
5. Avdonina NG, Zvartau NE, Emelianov IV, Vasilieva EY, Khokhurov OA, Polekhin SA, et al. The prevalence of primary aldosteronism in patients with uncontrolled hypertension and in patients with previously detected adrenal incidentaloma: the database of antihypertensive specialized center. *Arterial Hypertension*. 2013;19(6):538–44. Russian. <https://doi.org/10.18705/1607-419x-2013-19-6-538-544>
6. Funder JW, Carey RM, Mantero F, Murad MH, Reincke M, Shibata H, et al. The Management of Primary Aldosteronism: Case Detection, Diagnosis, and Treatment: An Endocrine Society Clinical Practice Guideline. *J Clin Endocrinol Metab*. 2016;101(5):1889–916. <https://doi.org/10.1210/jc.2015-4061>
7. Monticone S, Burrello J, Tizzani D, Bertello C, Viola A, Buffolo F, et al. Prevalence and clinical manifestations of primary aldosteronism encountered in primary care practice. *J Am Coll Cardiol*. 2017;69(14):1811–20. <https://doi.org/10.1016/j.jacc.2017.01.052>
8. Romero DG, Yanes Cardozo LL. Clinical Practice Guideline for Management of Primary Aldosteronism: What is New in the 2016 Update? *Int J Endocrinol Metab Disord*. 2016;2(3). <https://doi.org/10.16966/2380-548X.129>
9. Kalyagin AN, Beloborodov VA, Maksimova TN. Symptomatic arterial hypertension against the background of primary aldosteronism. *Arterial hypertension*. 2017;23(3):224–30. Russian. <https://doi.org/10.18705/1607-419X-2017-23-3-224-230>
10. Zavatto A, Concistrè A, Marinelli C, Zingaretti V, Umbro I, Fiacco F, et al. Hypokalemic rhabdomyolysis: a rare manifestation of primary aldosteronism. *Eur Rev Med Pharmacol Sci*. 2015;19(20):3910–6.
11. Cooray MA, Bulugahapitiya US, Peiris DN. Rhabdomyolysis: A rare presentation of aldosterone-producing adenoma. *Indian J Endocrinol Metab*. 2013;17(Suppl 1):S237–9. <https://doi.org/10.4103/2230-8210.119583>
12. Goto A, Takahashi Y, Kishimoto M, Minowada S, Aibe H, Hasuo K, et al. Primary Aldosteronism Associated with Severe Rhabdomyolysis Due to Profound Hypokalemia. *Intern Med*. 2009;48(4):219–23. <https://doi.org/10.2169/internalmedicine.48.1444>
13. Tsai W, Chen Y, Yang W, Lin H, Chien C, Lin C. Primary aldosteronism associated with severe hypokalemic rhabdomyolysis. *Hormones*. 2012;11(4):505–6. <https://doi.org/10.14310/horm.2002.1385>
14. Cakir I, Senol S, Simsek Y, Karaca Z, Unluhizarci K, Tanriverdi F. Primary aldosteronism presenting with rhabdomyolysis in emergency room – Case report. *J Acute Dis*. 2016;5(3):264–6. <https://doi.org/10.1016/j.joad.2016.03.020>
15. Yao B, Qin Z, Tan Y, He Y, Yan J, Liang Q et al. Rhabdomyolysis in Primary Aldosteronism: A Case Report and Review of the Literature. *AACE Clin Case Rep*. 2015;1(1):e21–7. <https://doi.org/10.4158/ep14277.cr>
16. Allison RC, Bedsole DL. The Other Medical Causes of Rhabdomyolysis. *Am J Med Sci*. 2003;326(2):79–88. <https://doi.org/10.1097/00000441-200308000-00005>
17. Vakkalanka S, Zhao A, Samannodi M. Primary aldosteronism: a case of unilateral adrenal hyperplasia with contralateral incidentaloma. *BMJ Case Rep*. 2016;2016:bcr2016216209. <https://doi.org/10.1136/bcr-2016-216209>
18. Burton T, Mackenzie I, Balan K, Koo B, Bird N, Soloviev DV, et al. Evaluation of the Sensitivity and Specificity of <sup>11</sup>C-Metomidate Positron Emission Tomography (PET)-CT for Lateralizing Aldosterone Secretion by Conn's Adenomas. *J Clin Endocrinol Metab*. 2012;97(1):100–9. <https://doi.org/10.1210/jc.2011-1537>

# METHICILLIN-RESISTANT STAPHYLOCOCCUS AUREUS IN COMMUNITY SETTINGS: SPREAD OF DRUG RESISTANCE AND UNCONTROLLABLE INFECTIONS

T. Yamamoto<sup>1,2</sup>, T.W. Wan<sup>1,3</sup>, O. Khokhlova<sup>1,2</sup>, W.C. Hung<sup>4</sup>, Y.T. Lin<sup>5</sup>, O. Peryanova<sup>2</sup>, L.J. Teng<sup>3</sup>

<sup>1</sup>Department of Epidemiology, Genomics, and Evolution, International Medical Education and Research Center, Niigata, Japan

<sup>2</sup>Russia-Japan Center of Microbiology, Metagenomics and Infectious Diseases, Krasnoyarsk State Medical University named after Prof. V.F. Voyno-Yasenetsky, Krasnoyarsk, Russia

<sup>3</sup>Department of Clinical Laboratory Sciences and Medical Biotechnology, National Taiwan University College of Medicine, Taipei, Taiwan

<sup>4</sup>Department of Microbiology and Immunology, Kaohsiung Medical University, Kaohsiung, Taiwan

<sup>5</sup>Department of Medical Laboratory Science and Biotechnology, China Medical University, Taichung, Taiwan

## Abstract

Methicillin-resistant *Staphylococcus aureus* (MRSA) is a major multidrug-resistant bacterial pathogen. The evolution of MRSA is dynamic posing an ongoing threat to humans. The evolution of MRSA includes horizontal gene transfer, which is mediated by mobile genetic elements, plasmids, and bacteriophages, and also mutations. In this review, we clarify the recent trends in MRSA from the perspectives of drug-resistance transfer and uncontrollable infections, particularly those occurring in community settings. We first address the role of MRSA as a disseminator of multidrug resistance. We have studied the cell-to-cell transfer of drug resistance, in which transfer frequencies range from 10<sup>-3</sup> to 10<sup>-8</sup>. The mechanisms of drug-resistance transfers include the self-transmission of large plasmids, the mobilization of small nonconjugative plasmids, the generalized transduction of phages, and the transfer of transposons with circular intermediates. We then discuss uncontrollable infections. Although several anti-MRSA agents have been developed, uncontrollable cases of MRSA infections are still reported. Examples include a case of uncontrollable sepsis arising from a community-associated MRSA (CA-MRSA) with the ST8/SCCmecIV genotype, and a relapsing severe invasive infection of ST30/SCCmecIVc CA-MRSA in a student athlete. Some of these cases may be attributable to unique adhesins, superantigens, or cytolytic activities. The delayed diagnosis of highly adhesive and toxic infections in community settings may result in CA-MRSA diseases that are difficult to treat. Repeated relapse, persistent bacteremia, and infections of small-colony variants may occur. To treat MRSA infections in community settings, these unique features of MRSA must be considered to ensure that diagnostic delay is avoided.

## Keywords

methicillin-resistant *Staphylococcus aureus* • community setting • drug resistance • antiseptic resistance • transfer • uncontrollable infection • pathotype • small-colony variants • adhesin • superantigen

## Introduction

Methicillin-resistant *Staphylococcus aureus* (MRSA) is a major multidrug-resistant (MDR) pathogen, recognized by the World Health Organization (WHO) in 2014 [1]. MRSA emerges from methicillin-susceptible *S. aureus* (MSSA) through the acquisition of the staphylococcal cassette chromosome *mec* (SCC*mec*) [2-4]. SCC*mec* is classified into several types, each containing several subtypes [2].

The term "MRSA" includes healthcare-associated MRSA (HA-MRSA) and community-associated MRSA (CA-MRSA) [4, 5]. HA-MRSAs are most frequently associated with infections in hospital in-patients, and are opportunistic pathogens. They are usually resistant to those antibacterial drugs agents

frequently used in hospital settings, such as fluoroquinolones [4-7]. Historically, limited numbers of MRSAs have evolved from MSSAs since the early 1960th, and have spread globally as major HA-MRSAs. Examples include ST239/SCC*mec*III and ST5/SCC*mec*II [8-11]. SCC*mec*II and SCC*mec*III are associated with HA-MRSA [3, 4]

CA-MRSA infections occur in healthy individuals in community settings, usually causing skin and soft-tissue infections, but occasionally causing invasive infections [4, 5]. CA-MRSA has been reported more recently than HA-MRSA, since 1997-1999 [12], and usually displays less multidrug resistance [4, 5]. The most successful

and well-characterized CA-MRSA clone is USA300 (ST8/SCC*mecIVa*), which caused an epidemic of serious invasive infections in the United States in 2007 [4, 5, 13, 14]. USA300 has since progressed to a nosocomial MDR pathogen and a global pathogen [13, 15]. CA-MRSA often produces Panton-Valentine leukocidin (PVL) [4, 14, 16], and ST8/SCC*mecIVa* (USA300) [4, 13], ST30/SCC*mecIV* [3, 17], ST59/SCC*mecV* [3, 18], and ST80/SCC*mecIV* [3, 19] are representative PVL-positive lineages. SCC*mecIV* and SCC*mecV* are common among CA-MRSA [3, 4]. The expression of cytolytic peptides (for example, phenol-soluble modulins, PSMs) is elevated in CA-MRSAs [20].

The evolution of MRSAs is dynamic and they, therefore, pose an ongoing threat to humans. The evolution of MRSAs includes horizontal gene transfer, which is mediated by mobile genetic elements, plasmids, and bacteriophages (phages), and also mutations [3, 4, 21-26]. In this review, we clarify the recent trends in MRSAs from the viewpoint of drug-resistance transfer and uncontrollable infections, particularly, those occurring in community settings.

## Methods

Our previously published data are used as the bases for this review. Data published by others are used to evaluate our data and to extend our discussion.

## Results and Discussion

We describe MRSAs as disseminators of multidrug resistance. We have studied the cell-to-cell transfer of drug resistance in MRSAs isolated in Russia, Japan, and Taiwan using a mixed culture method on membrane filters (filter mating). These previous data are summarized in Table 1 [18, 23, 24, 27-30]. A large plasmid of ca. 40 kb (pWMUP1), carrying the mupirocin-resistance gene (*mupA*), and a small 2.9-kb plasmid (p16K-1), carrying the chloramphenicol-resistance gene (*cat*), are transferred at high transfer frequencies of  $10^{-3}$  (drug-resistance-acquiring recipients per donor). Other plasmids show moderate transfer frequencies ( $10^{-4}$  to  $10^{-6}$ ) or low frequencies ( $10^{-7}$  to  $10^{-8}$ ). No transfer frequencies are lower than  $10^{-9}$  for naturally occurring chromosomal gene mutations in *gyrA* and *griA*, which generate levofloxacin resistance, or in *rpoB*, which generate rifampicin resistance. The transfer of drug resistance is frequently observed in CA-MRSAs (ST8/SCC*mecIV* and ST59/SCC*mecV*), whereas it is rather rare in HA-MRSAs (ST239/SCC*mecIII*). However, an emerging variant clade of classical ST239/SCC*mecIII*/

*spa3*[t037], that was isolated from patients with urethritis in community settings in Vladivostok, Russia, and displays a divergent *spa* type (*spa351*[t030]) [23], is more able to donate its drug resistance (for example, via the 2.9-kb *cat* plasmid p16K-1) than other HA-MRSAs.

It is noteworthy that when transposon Tn554 (carrying the erythromycin-resistance gene *ermA* and spectinomycin-resistance gene *aad9/spc*) is integrated into the bacterial chromosome, it can be transferred at low-to-moderate levels. Since Tn554 forms a circular intermediate DNA in an MRSA cell [23, 31, 32], there is a possibility that the Tn554 circular intermediate play a role in transfer, similar to small plasmids. Transposon Tn4001 (carrying the gentamicin-resistance gene *aacA-aphD*) in ST239/SCC*mecIII*/*spa351*[t030] can also be transferred at moderate levels. This Tn4001 occurs as a part of a larger transposon-like, mobile-element structure, MES16K [23], which may provide genetic background for efficient transfer. In the MRSA lineage ST8/SCC*mecIV*, Tn4001 is simply integrated into the bacterial chromosome [28] and shows no transfer.

Another large 32-kb plasmid (pWSI1) that is transferred at low-to-moderate frequencies carries the *qac* gene, encoding for resistance to antiseptics (quaternary ammonium; benzalkonium/benzethonium chloride, acroflavin, and ethidium bromide), and also the *edin/ednA* gene, which encodes the virulence factor, epidermal cell differentiation inhibitor (EDIN) [27-30].

Two modes of transfer are observed: one only occurs on a filter (for example, a ca. 40-kb plasmid [pWMUP1] containing *mupA*) and the other occurs on agar plates, both with and without filter (for example, a 32-kb plasmid [pWSI] containing *qac* and *edin* and a 2.9-kb plasmid [p16K-1] containing *cat*). Staphylococcal plasmid transfer requires cell-to-cell contact and is, therefore, generally performed on agar plates with membrane filters [33-35]. Large plasmids of 40-60 kb (a well-characterized example is the pSK41/pGO1 family) can be transferred to other bacterial cells by conjugation, with transfer frequencies ranging from  $10^{-4}$  to  $10^{-7}$  [33-35]. The conjugative transfer genes (*tra*) have been reported. For example, the 52-kb self-transmissible plasmid pGO1 has a 13.8-kb *trs* gene and 14 open reading frames (ORFs, A to N) [35]; its phenotype is resistance to gentamicin, trimethoprim, and quaternary ammonium. A ca. 40-kb *mupA* plasmid [pWMUP1] may have one of the highest transfer frequencies of all the conjugative plasmids. The transfer region (*tra*) of pWMUP1 is under investigation. Two other large plasmids, 26-kb pPM1 containing *blaZ*, *tetK*, and *cadD* and 32-kb pWSI1 containing *qac* and *edin*, show no homology to the *trs* region of pGO1.

Large conjugative plasmids can mobilize the transfer of some small plasmids (3.5-14.5 kb) into other bacterial cells [36-38], as shown in Fig. 1. These small plasmids are



called nonconjugative mobilizable plasmids. The process of mobilization [36, 37] is as follows: 1) filter mating provides close contact between the donor and recipient cells; 2) the *tra* region on a large conjugative plasmid creates a mating pore (the “small needle”) between the donor and recipient (the “small needle” formed by the type IV secretion system allows DNA to be injected into the recipient); 3) relaxase (Mob), encoded by the *mob* gene, interacts with the 5' plasmid sequence at the origin of transfer (*oriT*) to form (often with accessory proteins) a complex called “relaxosome”; 4) the relaxosome is recruited to the mating pore to transfer the plasmid DNA into the recipient cells; and 5) plasmid replication during conjugation, in both the donor and recipient, occurs via a rolling circle mechanism. Thus, the transfer of small nonconjugative mobilizable plasmids requires the help of large conjugative plasmids. Examples of Mob and *ori*, that differ from that shown in Fig. 1 have also been reported [36, 37].

Rolling-circle-replicating plasmids are generally less than 5 kb in size and are cryptic or encode only a single resistance gene [38]. The erythromycin-resistance gene *ermC* is located on nonconjugative mobilizable plasmids and is the *erm* gene most widespread among the staphylococci [39]. Tetracycline-resistance gene *tetK* is located on 4.4-4.7-kb nonconjugative mobilizable plasmids, with transfer frequencies ( $10^{-9}$ ) [40]. The chloramphenicol-resistance gene *cat* is also located on small (e.g., 2.9-kb) plasmids in many cases [23, 24], although *cat* is located on the unique movable element structure  $MES_{PM1}$  on the chromosome of MRSA (ST59/SCC*mecV*) in Taiwan [18] and *cat*-positive cases are very rare in Japan [24].

The distribution of plasmids in Krasnoyarsk, Russia is unique [23, 24]. Many MRSA only carry a 2.9-kb *cat* plasmid (e.g., pOC3 and pOC8), but often carry two species of *cat* plasmid. In Russia, inexpensive chloramphenicol is commonly administered to patients without a doctor's prescription as an ointment for skin injuries or burns as a tablet for gastroenteritis or as an eye lotion, exerting a strong selective pressure on MRSA to carry a *cap* plasmid [23, 24]. This suggests that small plasmids contribute to the micro-evolution of MRSA, adapting to community settings of each region in the world.

Plasmids are also transferred by phages [37, 41]. In MRSA, phage DNA can be integrated into the MRSA genome as a prophage. Prophages enter the lytic cycle if they are induced spontaneously or by the administration of, for example, fluoroquinolone. During the lytic cycle, the MRSA DNA (less than 45 kb), including plasmids, is packed into the phage particles with the phage genome (45 kb in size) to produce the phage capsid. The transducing particles then infect other bacterial cells and transfer the DNA contained within them. Thus, the phage transduction (generalized transduction) can also contribute to the transfer of small nonconjugative plasmids. The reports of *S. aureus* pathogenicity islands (SaPIs) are interesting in terms of phages. SaPIs are located in the MRSA

genome and carry various combinations of superantigen genes [37]. SaPIs require a helper phage for their transfer [37]. They also play a role in generalized transduction through SaPI capsids, in a process called “island-mediated transduction” [37].

MRSA have a restriction-modification system (type I or typeIII-like) to block horizontal gene transfer [42, 43]. Therefore, some MRSA will block the invasion of plasmid or phage DNA.

The data in Table 1 show that a high-level transfer group of a ca. 40-kb plasmid (pWMUP1) containing *mupA* may be a new type of conjugative plasmid. The high transfer ability of a 2.9-kb *cat*-containing plasmid (p16K-1) in a unique genetic background, ST239/SCC*mecIII*/*spa351*[t030], requires further study. The cell-to-cell transmission of Tn554 (*ermA*/*aad9*), through a circular intermediate, is a new finding. Some small plasmids (<5 kb in size) must be mobilized by the machinery of helper conjugative plasmids. In our studies, we have detected no *vanA*-gene-carrying plasmid, that is associated with vancomycin-resistant *Staphylococcus aureus* (VRSA) [44].

We next discuss uncontrollable infections. Although several anti-MRSA agents have been developed, uncontrollable cases of MRSA infections are still reported. Examples include an uncontrollable sepsis (with pulmonary embolism and multiple organ failure) attributed to CA-MRSA ST8/SCC*mecIV* [29], and a relapsing invasive infection of CA-MRSA ST30/SCC*mecIVc* in a student athlete [45, 46].

Superantigens [47] provide the toxicity of CA-MRSA infections. From the perspective of MRSA genetics, it is noteworthy that the classical HA-MRSA ST5/SCC*mecII* lineage [48], which is still predominant in Japan, and the emerging CA-MRSA ST8/SCC*mecIV* (CA-MRSA/J), which is associated with severe invasive diseases in Japan, including a fatal case [28,29], share similar features, including the superantigen gene cluster (*tst*, *sec*, *selI*), suggesting that these confer selective advantages. In Krasnoyarsk, Russia, a unique derivative of ST239/SCC*mecIII*/*spa3*[t037], which has acquired the *tst* gene, is widespread [24].

The *tst* gene product, toxic syndrome toxin 1 (TSST-1), is associated with toxic shock syndrome (TSS) [47], in which a “cytokine storm” is generated [47], and with invasive endocarditis [47]. Among the staphylococcal exotoxins (SEs) that act as superantigens, TSST-1 is the most potent because it polyclonally activates T cells (and also macrophages) at picomolar concentrations [47, 49]. TSST-1 also acts as an immune evasion factor [47, 50].

The delayed diagnosis of this possible toxic feature of superantigens, which may occur in community settings, may make CA-MRSA diseases difficult to treat. This may also be the case for the superantigen staphylococcal enterotoxin B (SEB), because SEB induces danger signals in host cells,



resulting in multiorgan injury and toxic shock [49]. The SEB gene is associated with MRSA with community-associated features; for example, SEB-producing CA-MRSAs include ST59/SCC*mecV* in Taiwan [18] and emerging ST764 variant of HA-MRSA ST5/SCC*mecII*, which has the virulence determinants of CA-MRSA, in Japan [51].

Adhesins play a key role in CA-MRSA infections in community settings, in bacterial spread and as virulence factors. For example, a key feature of CA-MRSA/J is the *spj* gene on SCC*mecIV*. *spj* encodes a large and highly variable cell-wall-anchored protein (Spj) [30]. CA-MRSA/J (ST8/SCC*mecVI*) is classified into different pathotypes based on the unique *spj* gene [29,30]: i) a strongly invasive type, isolated from a fatal infection [29], which was highly invasive in a HEp-2 cell infection model [29, 30], and has a short *spj* gene (lacking the sequence encoding 11/22-amino acid repeats) [30]; and ii) a possible adherent type, isolated from bullous impetigo [27], which was adherent in a HEp-2 cell infection model [29, 30], and has a large *spj* gene (containing the long sequence encoding 11/22-amino acid repeats) [30]. A delay diagnosis of the strongly invasive type may results in dangerous infections. Like USA300, CA-MRSA/J spreads widely in community settings, but the situations differ. PVL-negative CA-MRSA/J causes bullous impetigo in many cases and spreads directly or indirectly through skin contact [27, 30]. In contrast, PVL-positive USA300 causes severe skin lesions such as furuncles and carbuncles with large abscesses, initially called “spider bite” [52]. These abscesses allow USA300 to spread widely through skin contact either directly or indirectly [4, 53]. It is noteworthy that PVL-negative CA-MRSA/J causes severe invasive infections, attributable to a set of virulence factors (for example, Spj, TSST-1, and PSM $\alpha$ ) [29, 30] that differ from those of USA300 [4].

PVL-positive CA-MRSA ST30/SCC*mecIV* is also a unique and dangerous cause of severe invasive infections. It caused the first reported death case in Japan, in a child with pneumonia [54]. It was also associated with a relapsing invasive infections in a student athlete [45, 46]: the first episode involved osteomyelitis and simultaneous iliopsoas and piriformis abscesses, adjacent to the sacroiliac joint; the second and third episodes involved abscesses in tissues adjacent to the sacroiliac joint four and eight months after the first treatment. ST30/SCC*mecIV* is a globally spread CA-MRSA [3, 17, 55], and is characterized by a unique combination of the adhesion genes *cna* and *bbp* [17, 27, 54, 56], similar to globally spread

*S. aureus* ST121 (or its MRSA) [57]. The ST30 lineage has unique PSM $\alpha$  cytolytic activities [14,20,58] and causes blood stream infections with complications such as seeding to organs [58].

Small-colony variants (SCVs) are also associated with refractory infections [59], although usually in healthcare settings. SCVs have damaged bacterial cell structures [60, 61], and are resistant to drugs such as aminoglycosides, sulfamethoxazole, trimethoprim, fluoroquinolones, fusidic acid, and triclosan [62]. The case shown in Fig. 2 is a daptomycin-resistant SCV that emerged from HA-MRSA ST239/SCC*mecIII* during the treatment of a patient with daptomycin for septic arthritis [61]. SCVs of *S. aureus* have been isolated from a variety of infections including persistent and relapsing infections. Well-characterized SCVs include hemin-dependent SCVs, menadione-dependent SCVs, and thymidine-dependent SCVs [59].

MRSA bacteremia, which persist despite antibiotic therapy is a significant cause of morbidity and mortality [63]. Persistent MRSA bacteremia is defined as a positive blood culture maintained for 3 – 7 days after treatment [63]. Bacteremia of increased duration is associated with metastatic and complex infections [63]. A better understanding the pathogen-host interactions in persistent MRSA infections *in vivo* is required [63].

Therefore, to treat MRSA infections in community settings, the unique features of MRSA (or *S. aureus*) described above must be considered to ensure that delayed diagnoses are avoided.

## Acknowledgments

We thank Wataru Higuchi for technical information. This study was supported by the institutions of the authors, including personal money obtained from lectures at universities and colleges (TY).

## Conflict of Interest Statement

The authors declare that they have no conflicts of interest.

## References

- World Health Organization [site]. Antimicrobial resistance: global report on surveillance. Geneva: World Health Organization; 2014 [cited 2019 Oct 12]. 257 p. Available from: <http://www.who.int/mediacentre/news/releases/2014/amr-report/en/>.
- International Working Group on the Classification of Staphylococcal Cassette Chromosome Elements (IWG-SCC). Classification of staphylococcal cassette chromosome *mec* (SCC*mec*): guidelines for reporting novel SCC*mec* elements. *Antimicrob Agents Chemother*. 2009;53:4961–7. <http://dx.doi.org/10.1128/AAC.00579-09>
- David MZ, Daum RS. Community-associated methicillin-resistant *Staphylococcus aureus*: epidemiology and clinical consequences of an emerging epidemic. *Clin Microbiol Rev*. 2010;23:616–87. <http://dx.doi.org/10.1128/CMR.00081-09>
- Otto M. Community-associated MRSA: what makes them special? *Int J Med Microbiol*. 2013;303:324–30. <http://dx.doi.org/10.1016/j.ijmm.2013.02.007>
- Klevens RM, Morrison MA, Nadle J, Petit S, Gershman K, Ray S, et al. Invasive methicillin-resistant *Staphylococcus aureus* infections in the United States. *JAMA*. 2007;298:1763–71. <http://dx.doi.org/10.1001/jama.298.15.1763>
- Naimi TS, LeDell KH, Como-Sabetti K, Borchardt SM, Boxrud DJ, Etienne J, et al. Comparison of community- and health care-associated methicillin-resistant *Staphylococcus aureus* infection. *JAMA*. 2003;290:2976–84. <http://dx.doi.org/10.1001/jama.290.22.2976>
- Harinstein L, Schafer J, D'Amico F. Risk factors associated with the conversion of methicillin-resistant *Staphylococcus aureus* colonisation to healthcare-associated infection. *J Hosp Infect*. 2011;79:194–7. <http://dx.doi.org/10.1016/j.jhin.2011.03.017>
- Lyon BR, Skurray R. Antimicrobial resistance of *Staphylococcus aureus*: Genetic basis. *Microbiol Rev*. 1987;51:88–134.
- Oliveira DC, Tomasz A, de Lencastre H. The evolution of pandemic clones of methicillin-resistant *Staphylococcus aureus*: identification of two ancestral genetic backgrounds and the associated *mec* elements. *Microb Drug Resist*. 2001;7:349–61. <https://doi.org/10.1089/10766290152773365>
- Enright MC, Robinson DA, Randle G, Feil EJ, Grundmann H, Spratt BG. The evolutionary history of methicillin-resistant *Staphylococcus aureus* (MRSA). *Proc Natl Acad Sci U S A*. 2002;99:7687–92. <http://dx.doi.org/10.1073/pnas.122108599>
- Aires de Sousa M, Conceição T, Simas C, de Lencastre H. Comparison of genetic backgrounds of methicillin-resistant and -susceptible *Staphylococcus aureus* isolates from Portuguese hospitals and the community. *J Clin Microbiol*. 2005;43:5150–7. <http://dx.doi.org/10.1128/JCM.43.10.5150-5157.2005>
- Centers for Disease Control and Prevention (CDC). Four pediatric deaths from community-acquired methicillin-resistant *Staphylococcus aureus* - Minnesota and North Dakota, 1997-1999. *MMWR Morb Mortal Wkly Rep*. 1999;48:707–10.
- Diep BA, Gill SR, Chang RF, Phan TH, Chen JH, Davidson MG, et al. Complete genome sequence of USA300, an epidemic clone of community-acquired methicillin-resistant *Staphylococcus aureus*. *Lancet*. 2006;367:731–9. [http://dx.doi.org/10.1016/S0140-6736\(06\)68231-7](http://dx.doi.org/10.1016/S0140-6736(06)68231-7)
- Diep BA, Otto M. The role of virulence determinants in community-associated MRSA pathogenesis. *Trends Microbiol*. 2008;16:361–9. <http://dx.doi.org/10.1016/j.tim.2008.05.002>
- Tenover FC, Goering RV. Methicillin-resistant *Staphylococcus aureus* strain USA300: origin and epidemiology. *J Antimicrob Chemother*. 2009;64:441–6. <http://dx.doi.org/10.1093/jac/dkp241>
- Shallcross LJ, Fragaszy E, Johnson AM, Hayward AC. The role of the Pantone-Valentine leucocidin toxin in staphylococcal disease: A systematic review and meta-analysis. *Lancet Infect Dis*. 2013;13:43–54. [http://dx.doi.org/10.1016/S1473-3099\(12\)70238-4](http://dx.doi.org/10.1016/S1473-3099(12)70238-4)
- Isobe H, Takano T, Nishiyama A, Hung WC, Kuniyuki S, Shibuya Y, et al. Evolution and virulence of Pantone-Valentine leukocidin-positive ST30 methicillin-resistant *Staphylococcus aureus* in the past 30 years in Japan. *Biomed Res*. 2012;33:97–109. <http://dx.doi.org/10.2220/biomedres.33.97>
- Hung WC, Takano T, Higuchi W, Iwao Y, Khokhlova O, Teng LJ, et al. Comparative genomics of community-acquired ST59 methicillin-resistant *Staphylococcus aureus* in Taiwan: novel mobile resistance structures with IS1216V. *PLoS One*. 2012;7:e46987. <http://dx.doi.org/10.1371/journal.pone.0046987>
- Fluit AC, Carpaij N, Majoor EA, Weinstein RA, Aroutcheva A, Rice TW, et al. Comparison of an ST80 MRSA strain from the USA with European ST80 strains. *J Antimicrob Chemother*. 2015;70:664–9. <http://dx.doi.org/10.1093/jac/dku459>
- Wang R, Braughton KR, Kretschmer D, Bach TH, Queck SY, Li M, et al. Identification of novel cytolytic peptides as key virulence determinants for community-associated MRSA. *Nat Med*. 2007;13:1510–4. <http://dx.doi.org/10.1038/nm1656>
- Uhlemann AC, Otto M, Lowy FD, DeLeo FR. Evolution of community- and healthcare-associated methicillin-resistant *Staphylococcus aureus*. *Infect Genet Evol*. 2014;21:563–74. <http://dx.doi.org/10.1016/j.meegid.2013.04.030>
- Thurlow LR, Joshi GS, Richardson AR. Virulence strategies of the dominant USA300 lineage of community-associated methicillin-resistant *Staphylococcus aureus* (CA-MRSA). *FEMS Immunol Med Microbiol*. 2012;65:5–22. <http://dx.doi.org/10.1111/j.1574-695X.2012.00937.x>
- Yamamoto T, Takano T, Higuchi W, Iwao Y, Singur O, Reva I, et al. Comparative genomics and drug resistance of a geographic variant of ST239 methicillin-resistant *Staphylococcus aureus* emerged in Russia. *PLoS One*. 2012;7:e29187. <http://dx.doi.org/10.1371/journal.pone.0029187>

24. Khokhlova OE, Hung WC, Wan TW, Iwao Y, Takano T, Higuchi W, et al. Healthcare- and community-associated methicillin-resistant *Staphylococcus aureus* (MRSA) and fatal pneumonia with pediatric deaths in Krasnoyarsk, Siberian Russia: unique MRSA's multiple virulence factors, genome, and stepwise evolution. *PLoS One*. 2015;10:e0128017. <http://dx.doi.org/10.1371/journal.pone.0128017>
25. Wan TW, Khokhlova OE, Iwao Y, Higuchi W, Hung WC, Reva IV, et al. Complete circular genome sequence of successful ST8/SCCmecIV community-associated methicillin-resistant *Staphylococcus aureus* (OC8) in Russia: one-megabase genomic inversion, IS256's spread, and evolution of Russia ST8-IV. *PLoS One*. 2016;11(10):e0164168. <http://dx.doi.org/10.1371/journal.pone.0164168>
26. Firth N, Jensen SO, Kwong SM, Skurray RA, Ramsay JP. Staphylococcal plasmids, transposable and integrative elements. *Microbiol Spectr*. 2018;6:GPP3-0030-2018. <http://dx.doi.org/10.1128/microbiolspec.GPP3-0030-2018>
27. Takizawa Y, Taneike I, Nakagawa S, Oishi T, Nitahara Y, Iwakura N, et al. A Panton-Valentine leucocidin (PVL)-positive community-acquired methicillin-resistant *Staphylococcus aureus* (MRSA) strain, another such strain carrying a multiple-drug resistance plasmid, and other more-typical PVL-negative MRSA strains found in Japan. *J Clin Microbiol*. 2005;43:3356–63. <http://dx.doi.org/10.1128/JCM.43.7.3356-3363.2005>
28. Iwao Y, Ishii R, Tomita Y, Shibuya Y, Takano T, Hung WC, et al. The emerging ST8 methicillin-resistant *Staphylococcus aureus* clone in the community in Japan: associated infections, genetic diversity, and comparative genomics. *J Infect Chemother*. 2012;18:228–40. <http://dx.doi.org/10.1007/s10156-012-0379-6>
29. Ishitobi N, Wan TW, Khokhlova OE, Teng LJ, Yamamori Y, Yamamoto T. Fatal case of ST8/SCCmecIV community-associated methicillin-resistant *Staphylococcus aureus* infection in Japan. *New Microbes New Infect*. 2018;26:30–6. <http://dx.doi.org/10.1016/j.nmni.2018.08.004>
30. Wan TW, Teng LJ, Yamamoto T. Structures of a highly variable cell-wall anchored protein-encoding the *spj* gene from ST8/SCCmecIV community-associated methicillin-resistant *Staphylococcus aureus* (CA-MRSA/J) isolated from 2003 onwards: An indicator of a strongly invasive pathotype. *Microbiol Immunol*. 2019;63:186–93. <http://dx.doi.org/10.1111/1348-0421.12684>
31. Haroche J, Allignet J, El Solh N. Tn5406, a new staphylococcal transposon conferring resistance to streptogramin a and related compounds including dalbopristin. *Antimicrob Agents Chemother*. 2002;46:2337. <http://dx.doi.org/10.1128/aac.46.8.2337-2343.2002>
32. Kadlec K, Schwarz S. Identification of the novel *dfkK*-carrying transposon Tn559 in a porcine methicillin-susceptible *Staphylococcus aureus* ST398 strain. *Antimicrob Agents Chemother*. 2010;54:3475–7. <http://dx.doi.org/10.1128/AAC.00464-10>
33. Archer GL, Johnston JL. Self-transmissible plasmids in staphylococci that encode resistance to aminoglycosides. *Antimicrob Agents Chemother*. 1983;24:70–7. <http://dx.doi.org/10.1128/aac.24.1.70>
34. Forbes BA, Schaberg DR. Transfer of resistance plasmids from *Staphylococcus epidermidis* to *Staphylococcus aureus*: Evidence for conjugative exchange of resistance. *J Bacteriol*. 1983;153:627–34.
35. Morton TM1, Eaton DM, Johnston JL, Archer GL. DNA sequence and units of transcription of the conjugative transfer gene complex (*trs*) of *Staphylococcus aureus* plasmid pGO1. *J Bacteriol*. 1993;175:4436–47. <http://dx.doi.org/10.1128/jb.175.14.4436-4447.1993>
36. Ramsay JP, Kwong SM, Murphy RJ, Yui Eto K, Price KJ, Nguyen QT, et al. An updated view of plasmid conjugation and mobilization in *Staphylococcus*. *Mob Genet Elements*. 2016;6:e1208317. <http://dx.doi.org/10.1080/2159256X.2016.1208317>
37. Haaber J, Penadés JR, Ingmer H. Transfer of antibiotic resistance in *Staphylococcus aureus*. *Trends Microbiol*. 2017;25:893–905. <http://dx.doi.org/10.1016/j.tim.2017.05.011>
38. Khan SA. Rolling-circle replication of bacterial plasmids. *Microbiol Mol Biol Rev*. 1997;61:442–55.
39. Feßler A, Kadlec K, Wang Y, Zhang WJ, Wu C, Shen J, et al. Small antimicrobial resistance plasmids in livestock-associated methicillin-resistant *Staphylococcus aureus* CC398. *Front Microbiol*. 2018;9:2063. <http://dx.doi.org/10.3389/fmicb.2018.02063>
40. Leroy S, Christieans S, Talon R. Tetracycline gene transfer in *Staphylococcus xylosus* *in situ* during sausage fermentation. *Front Microbiol*. 2019;10:392. <http://dx.doi.org/10.3389/fmicb.2019.00392>
41. McCarthy AJ, Lindsay JA. The distribution of plasmids that carry virulence and resistance genes in *Staphylococcus aureus* is lineage associated. *BMC Microbiol*. 2012;12:104. <http://dx.doi.org/10.1186/1471-2180-12-104>
42. Waldron DE, Lindsay JA. Sau1: A novel lineage-specific type I restriction-modification system that blocks horizontal gene transfer into *Staphylococcus aureus* and between *S. aureus* isolates of different lineages. *J Bacteriol*. 2006;188:5578–85. <http://dx.doi.org/10.1128/JB.00418-06>
43. Corvaglia AR, François P, Hernandez D, Perron K, Linder P, Schrenzel J. A type III-like restriction endonuclease functions as a major barrier to horizontal gene transfer in clinical *Staphylococcus aureus* strains. *Proc Natl Acad Sci U S A*. 2010;107:11954–8. <http://dx.doi.org/10.1073/pnas.1000489107>
44. McGuinness WA, Malachowa N, DeLeo FR. Vancomycin resistance in *Staphylococcus aureus*. *Yale J Biol Med*. 2017;90:269–81.
45. Okubo T, Yabe S, Otsuka T, Takizawa Y, Takano T, Dohmae S, et al. Multifocal pelvic abscesses and osteomyelitis from community-acquired methicillin-resistant *Staphylococcus aureus* in a 17-year-old basketball player. *Diagn Microbiol Infect Dis*. 2008;60:313–8. <http://dx.doi.org/10.1016/j.diagmicrobio.2007.10.008>
46. Isobe H, Miyasaka D, Ito T, Takano T, Nishiyama A, Iwao Y, et al. Recurrence of pelvic abscess from Pantone-Valentine leuko-

- cidin-positive community-acquired ST30 methicillin-resistant *Staphylococcus aureus*. *Pediatr Int*. 2013;55:120–3. <http://dx.doi.org/10.1111/j.1442-200X.2012.03612.x>
47. Spaulding AR, Salgado-Pabón W, Kohler PL, Horswill AR, Leung DY, Schlievert PM. Staphylococcal and streptococcal superantigen exotoxins. *Clin Microbiol Rev*. 2013;26:422. <http://dx.doi.org/10.1128/CMR.00104-12>
48. Kuroda M, Ohta T, Uchiyama I, Baba T, Yuzawa H, Kobayashi I, et al. Whole genome sequencing of methicillin-resistant *Staphylococcus aureus*. *Lancet*. 2001;357:1225–40. [http://dx.doi.org/10.1016/S0140-6736\(00\)04403-2](http://dx.doi.org/10.1016/S0140-6736(00)04403-2)
49. Krakauer T. Staphylococcal superantigens: Pyrogenic toxins induce toxic shock. *Toxins (Basel)*. 2019;11:E178. <http://dx.doi.org/10.3390/toxins11030178>
50. Vojtov N, Ross HF, Novick RP. Global repression of exotoxin synthesis by staphylococcal superantigens. *Proc Natl Acad Sci U S A*. 2002;99:10102–7. <http://dx.doi.org/10.1073/pnas.152152499>
51. Takano T, Hung WC, Shibuya M, Higuchi W, Iwao Y, Nishiyama A, et al. A new local variant (ST764) of the globally disseminated ST5 lineage of hospital-associated methicillin-resistant *Staphylococcus aureus* (MRSA) carrying the virulence determinants of community-associated MRSA. *Antimicrob Agents Chemother*. 2013;57:1589–95. <http://dx.doi.org/10.1128/AAC.01147-12>
52. Dominguez TJ. It's not a spider bite, it's community-acquired methicillin-resistant *Staphylococcus aureus*. *J Am Board Fam Pract*. 2004;17:220–6. <http://dx.doi.org/10.3122/jabfm.17.3.220>
53. Mine Y, Higuchi W, Taira K, Nakasone I, Tateyama M, Yamamoto T, et al. Nosocomial outbreak of multidrug-resistant USA300 methicillin-resistant *Staphylococcus aureus* causing severe furuncles and carbuncles in Japan. *J Dermatol*. 2011;38:1167. <http://dx.doi.org/10.1111/j.1346-8138.2011.01284.x>
54. Ito T, Iijima M, Fukushima T, Nonoyama M, Ishii M, Baranovich T, et al. Pediatric pneumonia death caused by community-acquired methicillin-resistant *Staphylococcus aureus*, Japan. *Emerg Infect Dis*. 2008;14:1312–4. <http://dx.doi.org/10.3201/eid1408.070391>
55. Robinson DA, Kearns AM, Holmes A, Morrison D, Grundmann H, Edwards G, et al. Re-emergence of early pandemic *Staphylococcus aureus* as a community-acquired methicillin-resistant clone. *Lancet*. 2005;365:1256–8. [http://dx.doi.org/10.1016/S0140-6736\(05\)74814-5](http://dx.doi.org/10.1016/S0140-6736(05)74814-5)
56. Otsuka T, Saito K, Dohmae S, Takano T, Higuchi W, Takizawa Y, et al. Key adhesin gene in community-acquired methicillin-resistant *Staphylococcus aureus*. *Biochem Biophys Res Commun*. 2006;346:1234–44. <http://dx.doi.org/10.1016/j.bbrc.2006.06.038>
57. Wan TW, Tomita Y, Saita N, Konno K, Iwao Y, Hung WC, et al. Emerging ST121/agr4 community-associated methicillin-resistant *Staphylococcus aureus* (MRSA) with strong adhesin and cytolytic activities: trigger for MRSA pneumonia and fatal aspiration pneumonia in an influenza-infected elderly. *New Microbes New Infect*. 2016;13:17–21. <http://dx.doi.org/10.1016/j.nmni.2016.05.011>
58. Cheung GY, Kretschmer D, Duong AC, Yeh AJ, Ho TV, Chen Y, et al. Production of an attenuated phenol-soluble modulin variant unique to the MRSA clonal complex 30 increases severity of bloodstream infection. *PLoS Pathog*. 2014;10:e1004298. <http://dx.doi.org/10.1371/journal.ppat.1004298>
59. Kahl BC, Becker K, Löffler B. Clinical significance and pathogenesis of staphylococcal small colony variants in persistent infections. *Clin Microbiol Rev*. 2016;29:401–27. <http://dx.doi.org/10.1128/CMR.00069-15>
60. Kahl BC, Belling G, Reichelt R, Herrmann M, Proctor RA, Peters G. Thymidine-dependent small-colony variants of *Staphylococcus aureus* exhibit gross morphological and ultrastructural changes consistent with impaired cell separation. *J Clin Microbiol*. 2003;41:410–3. <http://dx.doi.org/10.1128/jcm.41.1.410-413.2003>
61. Lin YT, Tsai JC, Yamamoto T, Chen HJ, Hung WC, Hsueh PR, et al. Emergence of a small colony variant of vancomycin-intermediate *Staphylococcus aureus* in a patient with septic arthritis during long-term treatment with daptomycin. *J Antimicrob Chemother*. 2016;71:1807–14. <http://dx.doi.org/10.1093/jac/dkw060>
62. Precit MR, Wolter DJ, Griffith A, Emerson J, Burns JL, Hoffman LR. Optimized in vitro antibiotic susceptibility testing method for small-colony variant *Staphylococcus aureus*. *Antimicrob Agents Chemother*. 2016;60:1725–35. <http://dx.doi.org/10.1128/AAC.02330-15>
63. Mikkaichi T, Yeaman MR, Hoffmann A, MRSA Systems Immunobiology Group. Identifying determinants of persistent MRSA bacteremia using mathematical modeling. *PLoS Comput Biol*. 2019;15:e1007087. <http://dx.doi.org/10.1371/journal.pcbi.1007087>

**Table Captions**

**Table 1.** Transfer of relevant drug resistance from MRSA by filter mating

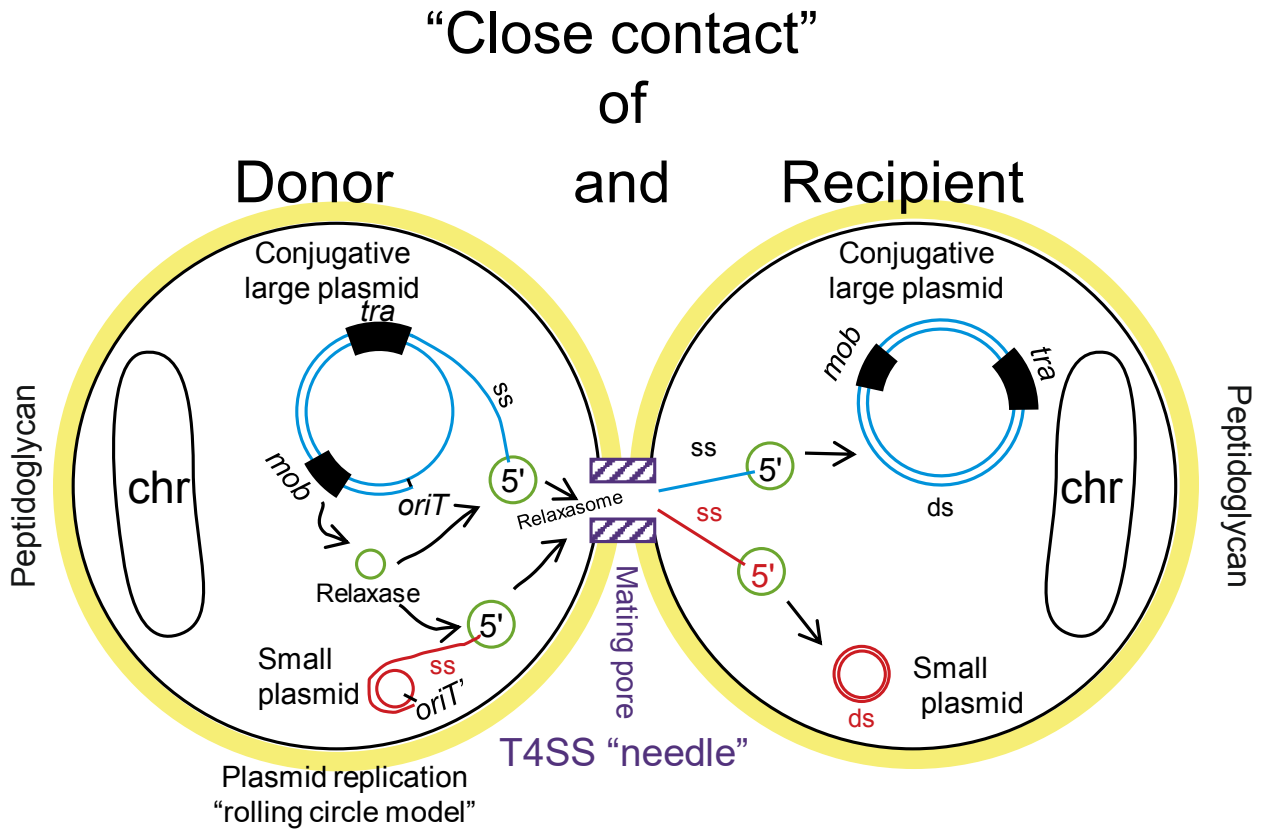
Group and MRSA genotype [Isolation]	Drug resistance and others (gene)	Gene location/genetic vehicle (size) [representative plasmid]	Genetic status in transconjugants	Transfer frequency (R+ recipient/donor) [Nonfilter mating]	Reference
1) Small plasmid group					
ST239/SCCmecIII ( <i>spa351/t030</i> ) [Russia]	CHL ( <i>cat</i> )	Plasmid (2.9 kb) [p16K-1]	Plasmid	10 <sup>-3</sup> – 10 <sup>-4</sup> [10 <sup>-3</sup> – 10 <sup>-4</sup> ]	23, 24
ST8/SCCmecIVc [Russia]	CHL ( <i>cat</i> )	Plasmid (2.9 kb) [pOC8]	Plasmid	10 <sup>-4</sup> – 10 <sup>-5</sup>	24
ST239/SCCmecIII ( <i>spa3/t037</i> ) [Russia]	CHL ( <i>cat</i> )	Plasmid (2.9 kb) [pOC3]	Plasmid	10 <sup>-7</sup>	24
ST8/SCCmecIVc [Russia]	ERY/CLI ( <i>ermC</i> )	Plasmid (2.5 kb) [pOC160-1]	Plasmid	10 <sup>-7</sup>	24
ST8/SCCmecVI [Japan]	ERY/CLI ( <i>ermC</i> )	Plasmid (2.5 kb) [pWEM1]	Plasmid	10 <sup>-7</sup> – 10 <sup>-8</sup>	Unpublished data (Wan et al.)
ST8/SCCmecVI [Japan]	TET ( <i>tetK</i> )	Plasmid (ca. 4.8 kb) [pWTC1]	Plasmid	10 <sup>-8</sup>	Unpublished data (Wan et al.)
2) Large plasmid group					
ST8/SCCmecVI [Japan]	MUP ( <i>mupA</i> ), NEO/KAN ( <i>aadD</i> ), AMP ( <i>blaZ</i> )	Plasmid (ca. 40 kb) [pWMUP1]	Plasmid	10 <sup>-3</sup> [≤ 10 <sup>-9</sup> ]	Unpublished data (Wan et al.)
ST8/SCCmecVI [Japan]	BEN/ACR/ETH ( <i>qacA/B</i> ), EDIN ( <i>edin/ednA</i> )	Plasmid (32 kb)	Plasmid [pWSI1]	10 <sup>-6</sup> – 10 <sup>-7</sup> [10 <sup>-6</sup> – 10 <sup>-7</sup> ]	27-30
ST59/SCCmecV [Taiwan]	AMP ( <i>blaZ</i> ), TET ( <i>tetK</i> ), CAD ( <i>cadD</i> )	Plasmid (26 kb) [pPM1]	Plasmid	10 <sup>-7</sup>	18
ST8/SCCmecIVc [Russia]	GEN/KAN ( <i>aacA-aphD</i> ), BEN/ACR/ETH ( <i>qacA/B</i> ), AMP ( <i>blaZ</i> ), CAD ( <i>cadD</i> )	Plasmid (25-27 kb) [pOC160-L1, pOC1-L]	Plasmid	10 <sup>-7</sup> – 10 <sup>-8</sup>	24
3) Transposon (transposon-like) group					
ST239/SCCmecIII ( <i>spa351/t030</i> ) [Russia]	ERY/CLI ( <i>ermA</i> ), SPC ( <i>aad9/spc</i> )	Tn554/chr/6.7 kb cDNA	Tn554/chr	10 <sup>-4</sup> - 10 <sup>-5</sup>	23, 24
ST239/SCCmecIII ( <i>spa351/t030</i> ) [Russia]	GEN/KAN ( <i>aacA-aphD</i> )	Tn4001/MES16K/chr	Tn4001(ND)/chr	10 <sup>-5</sup> - 10 <sup>-6</sup>	23
ST239/SCCmecIII ( <i>spa3/t037</i> ) [Russia]	ERY/CLI ( <i>ermA</i> ), SPC ( <i>aad9/spc</i> )	Tn554/chr/6.7 kb cDNA	Tn554/chr	10 <sup>-7</sup>	24
ST8/SCCmecVI [Japan]	ERY/CLI ( <i>ermA</i> ), SPC ( <i>aad9/spc</i> )	Tn554/chr/6.7 kb cDNA	Tn554/chr	10 <sup>-6</sup> - 10 <sup>-8</sup>	30
ST8/SCCmecVI [Japan]	GEN/KAN ( <i>aacA-aphD</i> )	Tn4001/chr	-	≤ 10 <sup>-9</sup>	28
ST59/SCCmecV [Taiwan]	ERY/CLI ( <i>ermB</i> ), STR ( <i>tetK</i> ), CHL ( <i>cat</i> )	MES <sub>PM1</sub> /chr	-	≤ 10 <sup>-9</sup>	18
4) Chromosomal gene mutation group					
ST239/SCCmecIII ( <i>spa3/t037</i> ) [Russia]	LVX ( <i>gyrA, grlA</i> ), RIF ( <i>rpoB</i> )	-	-	≤ 10 <sup>-9</sup>	24
ST8/SCCmecIVc [Russia]	LVX ( <i>gyrA, grlA</i> )	-	-	≤ 10 <sup>-9</sup>	24

**Note:** For drug resistance transfer, donor (MRSA) and recipient (*S. aureus* RN2677) were mixed and cultured on a filter placed on agar plates. R<sup>+</sup> recipient, transconjugants *S. aureus* RN2677, which acquired drug resistance from MRSA. Results obtained with nonfilter mating (by mixed culture on an agar plate with no membrane filter) is shown in [ ]. Abtimicrobial or related agents: CHL, chloramphenicol; ERY, erythromycin; CLI, clindamycin; TET, tetracycline; MUP, mupirocin; NEO, neomycin; KAN, kanamycin; AMP, ampicillin; BEN, benzalkonium/benzethonium chloride; ACR, acroflavin; ETH, ethidium bromide; TET, tetracycline; CAD, cadmium; GEN, gentamicin; SPC, spectinomycin, STR, streptomycin; LVX, levofloxacin, RIF, rifampicin. Virulence factor: EDIN, epidermal cell differentiation inhibitor (gene, *edin* or *ednA*). cDNA, circular DNA intermediate; chr, chromosome. ND, not determined.



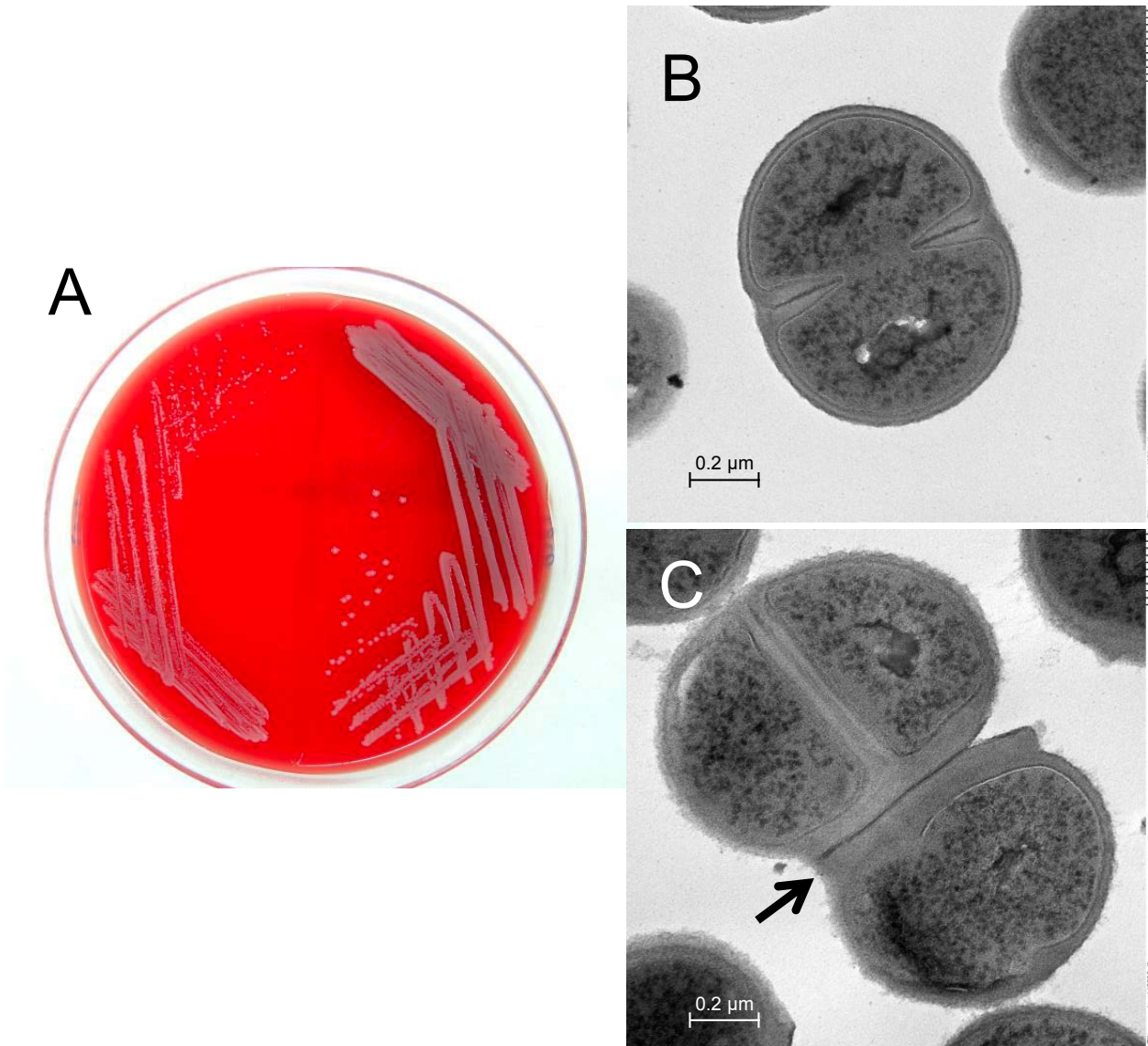
**Figure Legends**

**Figure 1.** Mobilization of small plasmids by the machinery of a helper conjugative plasmid. The figure is drawn based on the information in references [36-38]. Abbreviation: Chr, chromosome (MRSA DNA); ss, single-stranded (DNA); ds, double-stranded (DNA). Yellow, peptidoglycan (cell wall); purple, mating pore (type IV secretion system); blue, large conjugative plasmid DNA; red, small plasmid DNA; green, relaxase protein. Relaxase binds to the 5' end (at *oriT*) of the plasmid ss DNA, which forms during the rolling-circle replication of the plasmid DNA, generating a nucleoprotein complex, referred to as a “relaxasome”. The relaxasome recruits the 5' end of the plasmid ss DNA to the mating pore. The type IV secretion system then transfers the 5' end of the plasmid ss DNA to the recipient cell through its “needle”. The transferred plasmid ss DNA is converted to ds DNA in the recipient cell. In this figure, the small plasmid has an *oriT* mimic (*oriT'*), therefore, relaxase also binds to the 5' end of the small plasmid's ss DNA, and recruits it to the mating pore for mobilization. For this conjugation process in *S. aureus* (MRSA), the donor and recipient cells must be in close contact because *S. aureus* (MRSA) has a thick peptidoglycan payler.





**Figure 2.** Photographs of daptomycin-resistant small-colony variants (SCVs) derived from HA-MRSA ST239/SCC*mecIII*. Data are from reference [61]. (A) Normal growth of the wild type (right); and SCVs that emerged during treatment (left). (B) Transmission electron micrograph of the wild type. (C) Transmission electron micrograph of SCVs. Arrow indicate the thick cell walls of SCVs. SCVs also display irregular cell division.



# POSSIBLE DELETERIOUS IMPACT OF GLYPHOSATE AND ITS COMMERCIAL FORMULATION IN REPRODUCTIVE HEALTH OF FISHES

I. Argou-Cardozo<sup>1</sup>, F. Zeidán-Chuliá<sup>2,3</sup>

<sup>1</sup>Specialization Course in Public Management and Regional Development, Faculty of Administration and Tourism, Federal University of Pelotas (UFPEl), 96010-610 Pelotas, RS, Brazil;

<sup>2</sup>Departamento de Ciencias Biomédicas Básicas, Facultad de Ciencias Biomédicas y de la Salud, Universidad Europea de Madrid, 28670 Villaviciosa de Odón, Spain;

<sup>3</sup>Faculty of Medicine, University of Turku, FI-20520 Turku, Finland.

## Abstract

Glyphosate (GLY) is the active ingredient of Roundup® and it is the most utilized herbicide worldwide in the maintenance of conventional agricultural crops, and lawns in parks. A growing number of studies have associated environmental GLY to different pathologies such as obesity, diabetes, heart disease, Alzheimer's disease, depression, and autism. Different fish species have been used for a long time as experimental biological models to measure the environmental impact of different substances. Therefore, the present study approached the possible association between the exposure to GLY / Roundup® and the ecotoxicological impact on fish reproductive health. With this goal, we performed a comprehensive analysis of the literature and its content by systematic review of international databases. Two independent electronic searches were performed on *Medline / PubMed* and *Scielo* for identifying relevant studies published in English up to September 2019. The application of inclusion / exclusion criteria settled the boundaries for this systematic review and after qualitative analysis of the data; we found evidences that suggest a link between the exposure to GLY / Roundup® with deleterious effects on reproductive health in eight different species of fish.

## Keywords

Health • Pollution • Pesticides • Commercial herbicides • Agrotoxics; Roundup® • Fish toxicity • Reproduction • Fertility • Indicators • Gene-environment Interactions • Systematic Review

## Introduction

Glyphosate (GLY) or N-(phosphonomethyl)glycine has been a widely used herbicide during the last 30 years which destroys plants and microorganisms by inhibiting the shikimate pathway. It was considered as '*practically non-toxic and not an irritant*' to both animals and humans since this biochemical route only exists in a small number of organisms that utilize the shikimic acid pathway to produce amino acids (e.g., green plants) [1, 2]. With all, a larger and growing body of literature has showed experimental evidence for potential adverse effects of GLY, its major metabolite aminomethylphosphonic acid (AMPA), as well as its commercial formulation Roundup® in humans. Different groups have studied the potential deleterious effects of GLY / Roundup® in the context of diverse and apparently unrelated human pathologies such as carcinogenesis and autism spectrum disorders (ASD), with particular interest on data suggesting mechanisms that may

undergo undetected in traditional toxicology studies, such as disruption of microbiome balance endocrine system at very low concentrations [3, 4]. As for physiological conditions, most causes of developmental aberrancies in animals are thought to deal with multifactorial gene-environment interactions and probably one the most important factor currently affecting human health is the close exposure to pesticides [5-9]. In addition, various reasons have been hypothesized for the growing human infertility rate, and environmental pollutants have been associated with this change [10-12]. On the basis of current knowledge of reproductive biology and toxicology, it is clear that many chemicals affecting reproduction may elicit their reproductive toxicity at a number of sites in both the male and the female reproductive system, interfering with reproductive ability or capacity with subsequent effects on lactation and the development of the offspring [13].

GLY is used for weed control in both cultivated and uncultivated areas and it is highly water-soluble [14]. This characteristic increases the risk for GLY and its adjuvants in their commercial formulation to contaminate surface and ground waters in application areas and therefore represents a serious threat to the ecological balance of the affected regions.

As a model organism, some general characteristics make many fishes valuable for pathological and toxicological studies with relevance in human health [15] and include: 1) high fecundity with externally fertilized, often transparent eggs, as well as relatively brief generation times (perfect feature for reproductive studies), and 2) easy exposure of aquatic animals to water-soluble compounds (e.g., contaminants, new drugs, and chemicals) through a relatively large epithelial surface area of gills and skin.

Thus, in the present systematic review, we search for literature evidence regarding the potential interrelation between the exposure to GLY / Roundup® and changes in reproductive health indicators of fish species.

- a. Only studies published in English;
- b. Studies performed in fish species (male & female animals);
- c. Studies that allow access to their specific data;
- d. The most recent data will be preferred in case of duplication.

#### 4. Selection of studies

The rigorous screening was independently conducted by two reviewers (IAC and FZC) with the predefined eligibility criteria above. Every study was identified and classified by its title and abstract to selection criteria. After initial screening of titles and abstract, the full articles were evaluated by the same reviewers. Situations of disagreement between authors were solved after discussion. For the second screening phase, the complete published article was read, analyzed, and discussed between both reviewers. Data regarding the study design and characteristics, sample size, year of publication, and limitations were collected from each included article.

## Methods

### 1. Systematic review question

Is there an interrelation between the exposure to GLY / Roundup® and changes in reproductive health in different fish species?

### 2. Search strategy

The literature was screened to find published articles linking GLY / Roundup® exposure to differences in reproductive health Indicators of fishes. Comprehensive and systematic electronic searches were performed on *Medline / Pubmed* (<https://www.ncbi.nlm.nih.gov/pubmed/>) and *Scielo* (<http://www.scielo.org/php/index.php?lang=es>) databases by two independent investigators (IAC and FZC), started from 16 January 2018 until 20 September 2019. The following terms were used: ["Roundup" or "Glyphosate"] AND ([Reproduction] or [Reproductive health] or [Fertility] or [Infertility]). Duplicate references were excluded and analyzed by the same two reviewers (IAC and FZC) based on inclusion and exclusion criteria. The authors performed a hand search of the reference lists from the selected published articles (in addition to the electronic search) to identify potentially missing studies / data that may deserve qualitative analysis in the present systematic review.

### 3. Selection criteria

Articles were included only if they dealt with evidence linking the exposure to GLY / Roundup® and changes in reproductive health in fish without time restrictions, based on the following inclusion criteria:

## Results and Discussion

The first electronic screening (see Figure 1 displaying the flowchart of the study selection) resulted in 148 titles from *Medline / Pubmed* and none from *Scielo* databases, in which no duplicated papers were found. Thus, a total of 148 articles were considered for potential inclusion. From those, 139 articles were excluded based on title and abstract (theoretical reviews and hypothesis with no experimental data were not considered), resulting in 10 full-texts that were identified (1 additional full-text article was included by manual search), according to the inclusion criteria in this systematic review (Table 1). In total, eight different fish species corresponding to eight different families were utilized in the selected studies (e.g., *Rhamdia quelen*, *Jenynsia multidentata*, *Poecilia vivipara*, *Danio rerio*, *Astyanax lacustris*, *Hypomesus transpacificus*, *Astrolebias nigrofasciatus*, and *Oryzias latipes*) displaying changes in reproductive health indicators such as number of copulations, mating and hatching success, sperm quality, embryo mortalities and/or malformations, and number of copulations among others (Figure 2).

In 2007, Soso et al. showed that the eventual entrance of sub-lethal doses of GLY into the ponds may have deleterious effects on *R. quelen* reproduction; and additionally, that the chronic and/or repeated exposure to this pesticide can negatively alter *R. quelen* reproduction [16]. Five years later, Hued's group demonstrated that acute and subchronic exposures to Roundup® induced a diversity of gill and liver histological alterations in the neotropical fish *J. multidentata* that might impair normal organ functioning and also caused decreased

sexual activity in male fish exposed to the herbicide for 7 and 28 days [17]. Furthermore, sperm quality seems to be also affected by Roundup® exposure. In this sense, a Brazilian study in 2013 showed detrimental effects in plasma membrane integrity and mitochondrial functionality in spermatid cells of *P. vivipara* induced by this herbicide at realistic concentrations, and thus capable of generating consequent changes in fish populations of *P. vivipara* [18]. Not only male individuals are affected but female gametocytes were also shown to have an impact after GLY exposure. In particular, the concentration of GLY used by Armiliato and colleagues (2014), which corresponds to the maximal concentration of this herbicide allowed for Brazilian inland waters, was sufficient to induce ovarian changes in *D. rerio* females associated with higher steroidogenic factor 1 (SF-1) expression [19]. As for Harayashiki's study (2013) [18] in *P. vivipara*, the effect of GLY on sperm quality was also investigated in *D. rerio* in 2014 [20]. Interestingly, this was the first study that demonstrated the harmful effects of GLY *per sé* in this fish, such as damaged sperm DNA, reduced integrity of the mitochondrial membrane and functionality, as well as decreased sperm motility [20]. In the same year, Uren Webster and collaborators demonstrated that both 10 mg/L Roundup® and 10 mg/L GLY exert a similar adverse impact on embryo survival and hatching, while 10 mg/L GLY reduces egg production [21]. Further studies focused concentration that is within legal limits in U.S.A and even in the more stringent limit set in Brazilian law and studied the effects of low concentrations of GLY-based herbicide in *A. lacustris*. Goncalves et al. observed that some spermatid cells submitted to GLY-based herbicides were able to survive and kept alive, but sperm motility was not detected, leading a significant lower sperm quality [22].

The application of herbicides has also been considered effective for limiting the growth of invasive aquatic plants. With all, the putative adverse effects of these herbicides on non-targeted organisms are not well studied and thus, the possible impact on aquatic ecosystems. With this porpoise, Jin et al. (2018) evaluated the effect of four herbicides (penoxsulam, imazamox, fluridone and GLY) on Delta Smelt's reproductive and detoxification systems, showing that both acute exposure to fluridone and GLY exert the most detrimental effects when compared to penoxsulam and imazamox in *H. transpacificus* [23]. It is not clear yet how GLY and other herbicides may affect ephemeral wetlands but the literature provides data highlighting the effect of Roundup® exposure not only in fish reproduction, but also in embryonic diapause and the embryonic upper thermal tolerance of other species such as *A. nigrofasciatus* [24]. In particular, 96 hours of exposure to the low and environmentally relevant Roundup® concentration of 0.36 mg a.e./L can significantly decrease fish fertility and its embryonic thermal tolerance [24]. Most of these reports [16-24] show evidence for direct toxicity and the question remaining would be whether exposures with low doses of

GLY / Roundup® may lead to adult onset toxicity through epigenetic-based mechanisms. At least one recent study from Smith and collaborators (2019) supports this idea and explains how Roundup® and its active ingredient GLY may induce developmental, reproductive, and epigenetic effects such as changes in the expression of reproductive genes in the brain, genes Involved in sex differentiation and gonad development of Japanese medaka (*O. latipes*) [25].

For humans, sources of exposure to GLY / Roundup® are numerous and affect a large segment of the *general* population. Those ones include dermal exposure from residential and commercial use, as well as inhalation through spray drift in high farming areas and through food consumption [26, 27]. On the other hand, fish models provide a number of exceptional advantages for biomedical research: 1) they require small laboratory infrastructure and can be bred and maintained in large numbers easily and at low cost, 2) they offer the chance to combine the analytical clarity of developmental biology with the power of genetics, and finally 3) that transgenic lines can be quickly generated [28]. We believe that the toxicological data in fish models presented in this systematic review suggest the need for further studies exploring the effects of GLY / Roundup® on reproductive health in humans.

## Conclusion

The results of the present systematic review demonstrate an association between GLY / Roundup® exposure and deleterious effects in fish reproduction reflected in dramatic changes in indicators of reproductive toxicity, and also provides a significant insight into ecological risks rendered by GLY and Roundup® exposure. Most importantly, we believe that further studies should be performed to elucidate any potential parallelism in the context of human reproductive health.

## Acknowledgments

FZC is grateful to FINDOS Turku Grant for Completing a Doctoral Degree (University of Turku), University of Turku Joint Research Grant Fund, and Selma and Maja-Lisa Selander's Fund (Minerva Foundation, Helsinki) for supporting this work.

## Conflict of Interest Statement

The authors declare that there is no conflict of interest regarding the publication of this article.



## References

- Bai SH, Ougbourne SM. Glyphosate: environmental contamination, toxicity and potential risks to human health via food contamination. *Environ Sci Pollut Res Int*. 2016;23(19):18988–9001. <https://doi.org/10.1007/s11356-016-7425-3>
- Gomes MP, Smedbol E, Chalifour A, Hénault-Ethier L, Labrecque M, Lepage L, et al. Alteration of plant physiology by glyphosate and its by-product aminomethylphosphonic acid: an overview. *J Exp Bot*. 2014;65(17):4691–703. <https://doi.org/10.1093/jxb/eru269>
- Davoren MJ, Schiestl RH. Glyphosate-based herbicides and cancer risk: a post-IARC decision review of potential mechanisms, policy and avenues of research. *Carcinogenesis*. 2018;39(10):1207–15. <https://doi.org/10.1093/carcin/bgy105>
- Argou-Cardozo I, Zeidán-Chuliá F. Clostridium Bacteria and Autism Spectrum Conditions: A Systematic Review and Hypothetical Contribution of Environmental Glyphosate Levels. *Med Sci (Basel)*. 2018;6(2):E29. <https://doi.org/10.3390/medsci6020029>
- Zeidán-Chuliá F, Argou-Cardozo I. Are Gene–Environment Interactions Underpinning the Development of Creative Polymathy? *Interchange*. 2018; 49(3):343–52. <https://doi.org/10.1007/s10780-018-9329-2>
- Lovely C, Rampersad M, Fernades Y, Eberhart J. Gene-environment interactions in development and disease. *Wiley Interdiscip Rev Dev Biol*. 2017;6(1). <https://doi.org/10.1002/wdev.247>
- Zeidán-Chuliá F, Rybarczyk-Filho JL, Salmina AB, de Oliveira BH, Noda M, Moreira JC. Exploring the multifactorial nature of autism through computational systems biology: calcium and the Rho GTPase RAC1 under the spotlight. *Neuromolecular Med*. 2013;15(2):364–83. <https://doi.org/10.1007/s12017-013-8224-3>
- Argou-Cardozo I, Cano Martín JC, Zeidán-Chuliá F. Dental amalgam fillings and the use of technological devices as an environmental factor: Updating the cumulative mercury exposure-based hypothesis of autism. *Eur J Dent*. 2017;11(4): 569–70. [https://doi.org/10.4103/ejd.ejd\\_222\\_17](https://doi.org/10.4103/ejd.ejd_222_17)
- Choudri BS, Charabi Y, Ahmed M. Pesticides and Herbicides. *Water Environ Res*. 2018;90(10):1663–78. <https://doi.org/10.2175/106143018X15289915807362>
- Foster WG. Environmental toxicants and human fertility. *Minerva Ginecol*. 2003;55(5):451–7.
- McCue K, DeNicola N. Environmental Exposures in Reproductive Health. *Obstet Gynecol Clin North Am*. 2019;46(3):455–68. <https://doi.org/10.1016/j.ogc.2019.04.005>
- May H, He X, Qi K, Wang T, Qi Y, Cui L, et al. Effects of environmental contaminants on fertility and reproductive health. *J Environ Sci (China)* 2019;77:210–17. <https://doi.org/10.1016/j.jes.2018.07.015>
- Mattison DR, Plowchalk DR, Meadows MJ, al-Juburi AZ, Gandy J, Malek A. Reproductive toxicity: male and female reproductive systems as targets for chemical injury. *Med Clin North Am*. 1990;74(2):391–411.
- Marques MN, Passos EA, da Silva MT, Correia FO, Santos AM, Gomes SS, et al. Determination of glyphosate in water samples by IC. *J Chromatogr Sci*. 2009;47(9):822–4.
- Schmale MC, Naim RS, Winn RN. Aquatic Animal Models of Human Disease. *Comp Biochem Physiol C Toxicol Pharmacol*. 2007;145(1):1–4.
- Soso AB, Barcellos LJ, Ranzani-Paiva MJ, Kreutz LC, Quevedo RM, Anziliero D, et al. Chronic exposure to sub-lethal concentration of a glyphosate-based herbicide alters hormone profiles and affects reproduction of female Jundiá (*Rhamdia quelen*). *Environ Toxicol Pharmacol*. 2007;23(3):308–13. <https://doi.org/10.1016/j.etap.2006.11.008>
- Hued AC, Oberhofer S, de los Ángeles Bistoni M. Exposure to a commercial glyphosate formulation (Roundup®) alters normal gill and liver histology and affects male sexual activity of *Jenynsia multidentata* (Anablepidae, Cyprinodontiformes). *Arch Environ Contam Toxicol*. 2012;62(1):107–17. <https://doi.org/10.1007/s00244-011-9686-7>
- Harayashiki CA, Varela AS Jr, Machado AA, Cabrera Lda C, Primel EG, Bianchini A, et al. Toxic effects of the herbicide Roundup in the guppy *Poecilia vivipara* acclimated to fresh water. *Aquat Toxicol*. 2013;142-143:176–84. <https://doi.org/10.1016/j.aquatox.2013.08.006>
- Armiliato N, Ammar D, Nezzi L, Stralio M, Muller YM, Nazari EM. Changes in ultrastructure and expression of steroidogenic factor-1 in ovaries of zebrafish *Danio rerio* exposed to glyphosate. *J Toxicol Environ Health A*. 2014;77(7):405–14. <https://doi.org/10.1080/15287394.2014.880393>
- Lopes FM, Varela Junior AS, Corcini CD, da Silva AC, Guazzelli VG, Tavares G, et al. Effect of glyphosate on the sperm quality of zebrafish *Danio rerio*. *Aquat Toxicol*. 2014;155:322–6. <https://doi.org/10.1016/j.aquatox.2014.07.006>
- Uren Webster TM, Laing LV, Florance H, Santos EM. Effects of glyphosate and its formulation, roundup, on reproduction in zebrafish (*Danio rerio*). *Environ Sci Technol*. 2014;48(2):1271–9. <https://doi.org/10.1021/es404258h>
- Gonçalves BB, Nascimento NF, Santos MP, Bertolini RM, Yasui GS, Giaquinto PC. Low concentrations of glyphosate-based herbicide cause complete loss of sperm motility of yellowtail tetra fish *Astyanax lacustris*. *J Fish Biol*. 2018;92(4):1218–24. <https://doi.org/10.1111/jfb.13571>
- Jin J, Kurobe T, Ramírez-Duarte WF, Bolotaolo MB, Lam CH, Pandey PK, et al. Sub-lethal effects of herbicides penoxsulam, imazamox, fluridone and glyphosate on Delta Smelt (*Hypomesus transpacificus*). *Aquat Toxicol*. 2018;197:79–88. <https://doi.org/10.1016/j.aquatox.2018.01.019>
- Zebral YD, Lansini LR, Costa PG, Roza M, Bianchini A, Robaldo RB. A glyphosate-based herbicide reduces fertility, embryonic upper thermal tolerance and alters embryonic diapause

- of the threatened annual fish *Austrolebias nigrofasciatus*. *Chemosphere*. 2018;196:260–9. <https://doi.org/10.1016/j.chemosphere.2017.12.196>
25. Smith CM, Vera MKM, Bhandari RK. Developmental and epigenetic effects of Roundup and glyphosate exposure on Japanese medaka (*Oryzias latipes*). *Aquat Toxicol*. 2019;210:215–26. <https://doi.org/10.1016/j.aquatox.2019.03.005>
26. Annett R, Habibi H, Hontela A. Impact of glyphosate and glyphosate-based herbicides on the freshwater environment. *J Appl Toxicol*. 2014;34(5):458–79. <https://doi.org/10.1002/jat.2997>
27. Damalas CA, Eleftherohorinos IG. Pesticide Exposure, Safety Issues, and Risk Assessment Indicators. *Int J Environ Res Public Health*. 2011;8(5): 1402–19. <https://doi.org/10.3390/ijerph8051402>
28. Scharf M. Beyond the zebrafish: diverse fish species for modeling human disease. *Dis Model Mech*. 2014;7(2):181–92. <https://doi.org/10.1242/dmm.012245>



**Figure Legends**

**Figure 1.** Graphical abstract representing the article selection flow chart of the present systematic review and selection criteria.

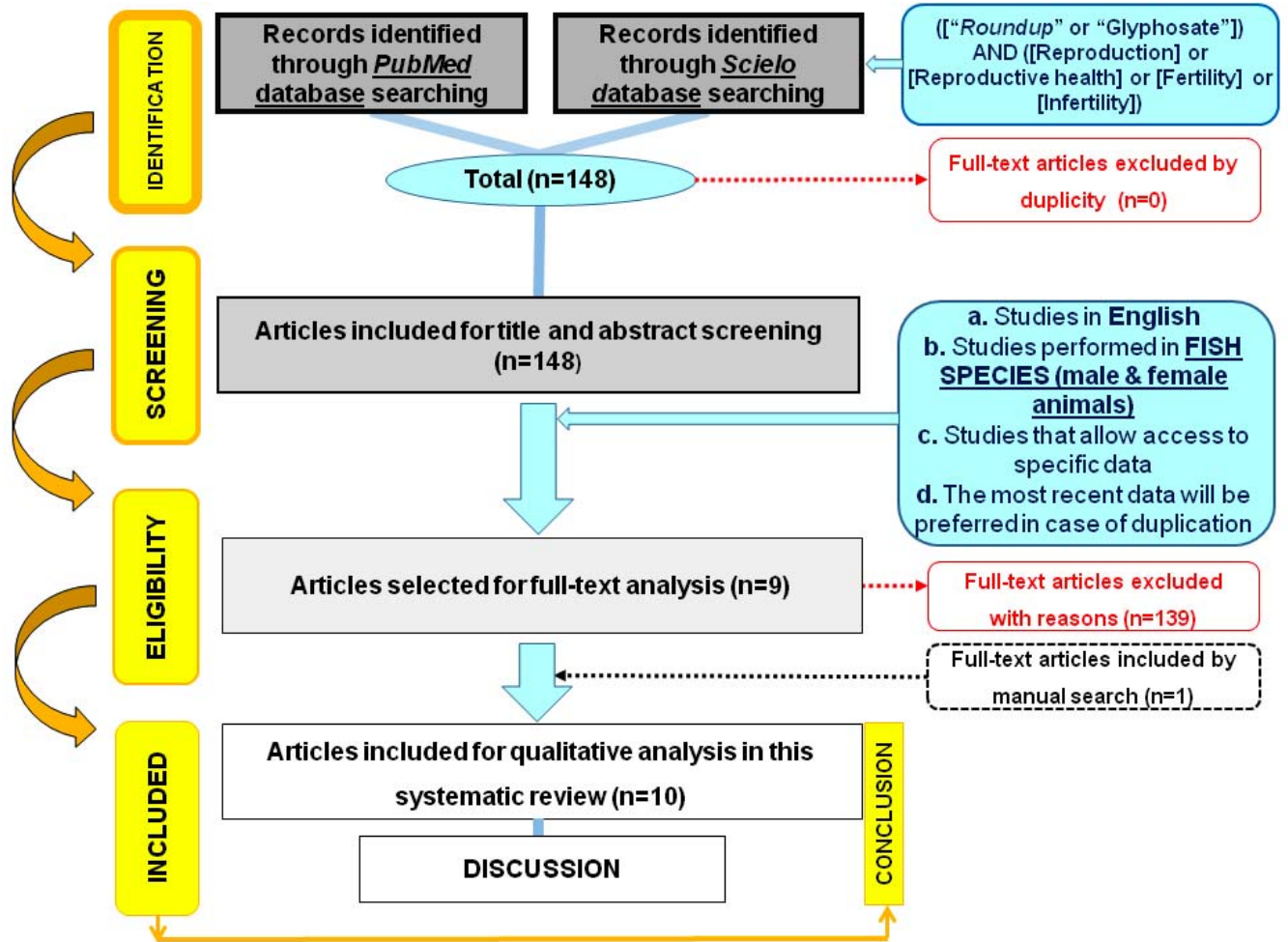
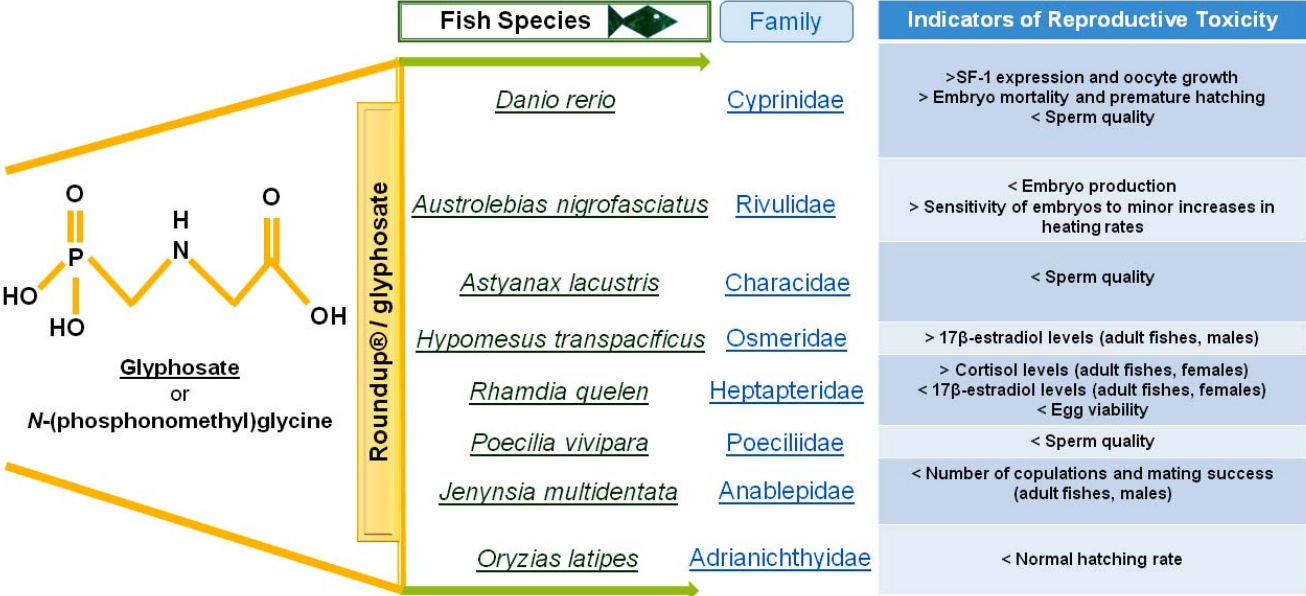


Figure 2. Graphical summary of the results extracted from the present systematic review.



## Table Captions

**Table 1.** Literature evidence for the possible deleterious impact of GLY / Roundup® in reproductive health indicators of fishes. The table summarizes the main results of ten studies included in this systematic review. The table is organized by year of publication.

TITLE	AUTHOR / YEAR	COUNTRY	PMID	MATERIAL	FISH SPECIES	CONCLUSIONS
Chronic exposure to sub-lethal concentration of a glyphosate-based herbicide alters hormone profiles and affects reproduction of female Jundiá ( <i>Rhamdia quelen</i> )	Soso et al., 2007	Brazil	21783773	Ovaries and blood samples taken from 8 females of each treatment immediately before or at 1, 10, 20, 30, and 40 days after exposure	<i>Rhamdia quelen</i>	The author's data indicated that the presence of glyphosate in water was deleterious to <i>Rhamdia quelen</i> reproduction, altering steroid profiles and egg viability
Exposure to a commercial glyphosate formulation (Roundup®) alters normal gill and liver histology and affects male sexual activity of <i>Jenynsia multidentata</i> (Anablepidae, Cyprinodontiformes)	Hued et al., 2012	Argentina	21643816	Adult male and female individuals of the common native species exposed to a sublethal Roundup® concentration (0.5 mg / l) for 7 and 28 days	<i>Jenynsia multidentata</i>	Roundup® also altered the normal histology of the organs studied and caused a significant decrease in mating number and mating success in male fish exposed to the herbicide
Toxic effects of the herbicide Roundup in the guppy <i>Poecilia vivipara</i> acclimated to fresh water	Harayashiki et al., 2013	Brazil	24036434	Tissue sample (brain, muscle, gills, and liver) and adult fish sperm	<i>Poecilia vivipara</i>	Male <i>Guppies</i> exposed to Roundup® had lower sperm quality, measured as reduced plasma membrane integrity, mitochondrial functionality, DNA integrity, motility, motility period, and sperm cell concentration than those maintained under control (without water addition)
Changes in Ultrastructure and Expression of Steroidogenic Factor-1 in Ovaries of Zebrafish <i>Danio rerio</i> Exposed to Glyphosate	Armiliato et al., 2014	Brazil	24617544	Ovaries (n = 18 per triplicate) were exposed to glyphosate for 15 days	<i>Danio rerio</i>	A significant increase in oocyte diameter was observed after glyphosate exposure (65 µg / L) and the presence of concentric membranes, appearing as myelin-like structures, associated with mitochondrial outer membranes and with calf granules. In addition, higher expression of steroidogenic factor-1 (SF-1) was found in oocytes, suggesting a relationship between oocyte growth and SF-1 expression.
Effect of glyphosate on the sperm quality of zebrafish <i>Danio rerio</i>	Lopes et al., 2014	Brazil	25089920	Adult fish sperm	<i>Danio rerio</i>	The authors investigated sperm quality in <i>Danio rerio</i> after 24 and 96 h of glyphosate exposure at concentrations of 5 and 10 mg / L. Their results showed a decrease in sperm motility. Mitochondrial functionality, membrane and DNA integrity were also reduced at the highest concentration during both exposure periods. These data showed that glyphosate may induce detrimental effects on reproductive parameters in <i>D. rerio</i> and that this change would reduce the fertility rate of these fish.
Effects of glyphosate and its formulation, Roundup®, on reproduction in zebrafish ( <i>Danio rerio</i> )	Uren Webster et al., 2014	UK	24364672	Embryos from 21 day rearing exposure of zebrafish ( <i>Danio rerio</i> ) at 0.01, 0.5 and 10 mg / L (glyphosate acid equivalent) Roundup® and 10 mg / L glyphosate	<i>Danio rerio</i>	Both 10 mg / L Roundup® and glyphosate increased early embryo mortality and premature hatching. However, exposure during embryogenesis alone did not increase embryonic mortality, suggesting that this effect was mainly caused by exposure during gametogenesis.

Table 1 (continued)

TÍTULO	AUTHOR / YEAR	COUNTRY	PMID	MATERIAL	FISH SPECIES	CONCLUSIONS
Low concentrations of glyphosate-based herbicide cause complete loss of sperm motility of yellowtail tetra fish <i>Astyanax lacustris</i>	Gonçalves et al., 2018	Brazil	29488225	Adult fish sperm (10 individuals)	<i>Astyanax lacustris</i>	The authors showed that relevant environmental concentrations of glyphosate-based herbicides ( $50 \mu\text{g l}^{-1}$ , $300 \mu\text{g l}^{-1}$ , and $1800 \mu\text{g l}^{-1}$ ) can affect the sperm quality of <i>Astyanax lacustris</i> fish. Sperm viability was impaired by $300 \mu\text{g l}^{-1}$ , a concentration that is within legal limits in US water bodies, while motility was impaired by $50 \mu\text{g l}^{-1}$ , which is the strictest limit established by law.
Sub-lethal effects of herbicides penoxsulam, imazamox, fluridone and glyphosate on Delta Smelt ( <i>Hypomesus transpacificus</i> )	Jin et al., 2018	USA	29448126	Liver and brain tissues of adult male and female fish (5 females and 5 males) in triplicate <i>per</i> treatment	<i>Hypomesus transpacificus</i>	The authors found that $17\beta$ -estradiol concentrations were significantly increased in female and male fishes exposed to $0.21 \mu\text{M}$ fluridone and in male fishes exposed to $0.46$ , $4.2$ , and $5300 \mu\text{M}$ glyphosate. GSH concentrations decreased in males exposed to $2.8 \mu\text{M}$ of fluridone and higher concentrations, and $4.2 \mu\text{M}$ glyphosate
A glyphosate-based herbicide reduces fertility, embryonic upper thermal tolerance and alters embryonic diapause of the threatened annual fish <i>Austrolebias nigrofasciatus</i>	Zebal et al., 2018	Brazil	29306198	Embryos from a total of 12 mating pairs of <i>A. nigrofasciatus</i>	<i>Austrolebias nigrofasciatus</i>	The results showed that fish couples exposed to $0.36 \text{ mg a}$ . Roundup® e./L produced fewer but larger embryos. In addition, embryos exposed to $3.62 \text{ mg a}$ . Roundup® e./L had a reduced proportion of pigmented embryos 30 days after exposure. In addition, embryos exposed to $0.32 \text{ mg a}$ . Roundup® e./L had a critical maximum thermal reduction of $2.6 \text{ }^\circ\text{C}$ and was more sensitive to smaller increases in heating rates. Their data indicated that Roundup® has negative results on fish reproduction and embryonic development
Developmental and epigenetic effects of Roundup and glyphosate exposure on Japanese medaka ( <i>Oryzias latipes</i> )	Smith et al., 2019	USA	30875550	Embryos were exposed to $0.5 \text{ mg/L}$ glyphosate, $0.5 \text{ mg/L}$ and $5 \text{ mg/L}$ Roundup® (glyphosate acid equivalent) for the first 15 days of their embryonic life and then allowed to sexually mature without further exposure	<i>Oryzias latipes</i>	Relevant concentrations of both Roundup® and glyphosate caused developmental abnormalities and epigenetic alterations in post-hatch medaka and alterations in expression of genes critical for reproduction in adulthood

# MOBILE ULTRASOUND SYSTEMS AS A MODERN TOOL FOR THE DOCTOR

O. Dzhioeva<sup>1</sup>

<sup>1</sup>National Medical Research Center for Preventive Medicine of the Ministry of Healthcare of the Russian Federation

## Abstract

Miniaturisation of ultrasound equipment in the form of a tablet- or smartphone-sized scanner is the result of rapid development of modern medical technology. Availability of mobile ultrasound devices has changed our approach to diagnostics of many cardiovascular diseases. Mobile visualisation can be performed at the patient's bedside and is simple in use. The information obtained from mobile visualisation, despite being incomplete, is of undoubtable value for rapid diagnosis which leads to early treatment onset. These devices possess unique characteristics: low cost, wide availability, safety, and precision. These characteristics make them usable in different clinical scenarios by operators of different specialties and expertise. Visualisation and interpretation of the images is done fast and provides useful diagnostic, prognostic and treatment data for each situation. This review devotes main attention to the regulation of application of mobile ultrasound devices, the notion of "focus cardiac ultrasound" and its differences from emergency and elective expert echocardiography protocols as well as limitations and numerous advantages related to usage of mobile ultrasound systems.

## Keywords

*mobile ultrasound • focus cardiac ultrasound • expert echocardiography • professional standard for the cardiologist*

## Introduction

Cardiovascular ultrasound is imaging with unique characteristics: it is safe, inexpensive, widely available, reproducible and precise. In fact, this is the most used method of cardiac visualization in clinical practice. Application of different echocardiography methods makes it possible to study the cardiac structure and intra-cardiac haemodynamic parameters in detail. 1-dimension (M-mode), 2-dimension (2D) and 3-dimension (3D) scanning determine dimensions and volumes of cardiac chambers, systolic function and the status of the valvular apparatus. Doppler (pulse-wave and continuous-wave) methods make it possible to conduct precise assessment of trans-valvular flows, tissue Doppler imaging (TDI) and longitudinal deformation or longitudinal strain (2 LDS) are capable of revealing clinical or subclinical systolic and diastolic dysfunction [1]. All collected echocardiography data has confirmed diagnostic and prognostic value [2].

Over many decades, echocardiography equipment was stationary, ultrasound scanning was performed in specially-outfitted echo-laboratories and functional/ultrasound diagnostics doctors were the only competent operators. With technological development, echocardiography equipment has become mobile, portative and miniaturised,

and ultrasound application has become more widespread: at the patient's bedside, in more varied clinical situations, for patients in the critical state. This served as a clinical "substrate" for expansion of professional competencies in clinicians [3]. In 2018, a new professional standard for the cardiologist was published in Russia. According to this standard, performing transthoracic ultrasound cardiac imaging is considered to be one of the competencies of this type of specialist<sup>1</sup>.

At the present time, different types of equipment are available with different sizes, options and diagnostic capabilities. This review is devoted to application of mobile ultrasound devices, their limitations and advantages associated with their usage.

Examinations using this equipment can be easily and rapidly performed and make it possible to collect main data for diagnostics in clinical scenarios. These scanners may be used by doctors in different areas of knowledge, in different clinical situations, especially in emergencies. Availability of

<sup>1</sup>Order: "On approval of the "Cardiologist" professional standard". The Ministry of Labour and Social Protection of the Russian Federation dated 14 March 2018. Russian.

mobile devices in real clinical practice has changed almost all aspects of our daily routine.

**Differentiation of echocardiographic equipment: from standard expert transthoracic echocardiography to focus ultrasound cardiac imaging**

*Standard expert transthoracic echocardiography* performed in specialised laboratories by expert echocardiographers provides information about heart dimensions, morphology, function and intra-cardiac haemodynamics. This is achieved through application of stationary system equipped with different modal systems and conversion units: 2D, M-mode, Doppler (pulse-wave, continuous-wave and color), TDI, transesophageal access (TEE), 2 LDS, 3D-echo and stress-testing. During the examination, all methods may be used if necessary. The assessment is performed in a certain order using standard positions of transthoracic echocardiography with complex alterations in cardiac structure, function and haemodynamics with obligatory ECG-synchronisation [4].

*Portable machines* have smaller sizes and make it possible to perform basic complex analysis using 2D, M-mode, pulse-wave, continuous-wave and colour Doppler. As a rule, they do not feature advanced modalities, the quality of images is good and the examination will be considered clinically complete. The concluding report describes all main morphological and functional characteristics of intra-cardiac haemodynamics.

*Mobile ultrasound systems* are the most mobile devices: a smartphone, a tablet or a sensor synchronised with these devices. They are very simple to use and have a limited number of main elements for depth and intensification control, as well as for saving of images (JPEG format) and small loops (MPEG-4 format). Available evaluations are limited to simple distance and surface assessment. The devices only have 2D-modality and colour Doppler, some systems allow using M-mode. Nevertheless, real-time 2D-modality and colour Doppler, imaging region, frame rate and conversion are analogical to those of expert scanners. Images provide good visualisation quality, which makes it possible in most cases to establish a correct final diagnosis [5-8]. The evaluation is performed with a limited number of positions. Oftentimes, the evaluation is qualitative with bimodal (yes/no) or semi-quantitative response. It is an enhancement for physical examination capabilities and emphasises detection of specific signs leading to the answer to diagnostic suspicions in particular clinical circumstances. It is also called FoCUS (focused ultrasound) as it is focused on collection of limited data [9-10] (see Table 1).

**Table 1.** The differences between FoCUS and expert emergency echocardiography

FoCUS	Expert emergency echocardiography
Decision making (targeted ultrasound)	Standard echocardiographic evaluation
Standard, but concise protocol	Full evaluation of intra-cardiac haemodynamics using an arsenal of additional means
The clinical decision is made by the operator	Ultrasound/functional diagnostics doctor (independent opinion)
FoCUS training	The doctor is specialised in echocardiography
Available usage of mobile devices	A fully-equipped cardiac ultrasound scanner

**Focus echocardiography in different clinical scenarios: when to use it**

The FoCUS may be used in many situations and numerous scenarios with different imaging protocols for stable or unstable patients. The area of application is relevant to both outpatient and inpatient settings and usage by operators in different specialties. Such linear measurements are available as left and right chamber sizes, wall thickness, dimensions of aorta and inferior vena cava, revealing of significant valvular regurgitation [9, 10]. Many studies described in the literature have shown that mobile ultrasound systems provide more precise diagnosis than standard physical examination for most widespread cardiovascular diseases and FoCUS results are in favourable correlation with standard echocardiography [9-12]. Thus, with consideration to the new standard for the cardiologist, mobile ultrasound is to be considered a new modern tool for a clinician. It serves as a basis for making decisions regarding the tactics of patient management including the necessity of expert echocardiographic examination. Therefore, focus imaging is not an alternative or a replacement for standard echocardiography. Quite the reverse, it allows to reveal more precisely which patients and in what order require the full protocol and which patients do not at this moment in time. FoCUS is suitable for screening of structural heart diseases in stable patients making it possible to perform early diagnostics, determined prognostic stratification and the necessity for more precise cardio-visualisation methods. The focus protocol might rapidly reveal/exclude change in qualitative contractility indices, wall motion abnormalities, systolic ventricular dysfunction. Left ventricle hypertrophy may be calculated knowing the height, weight and gender



of the patient, signs of systemic congestion, significant valvulopathies, aortic ectasia, pulmonary pleurae and pericardium separation, ultrasound profile of the lungs [11-13] (see Figure 1).

For unstable patients, mobile ultrasound provides immediate valuable information regarding critically important states that aids in revealing/excluding different pathologies, assess the clinical status and the prognosis [6, 13]. Numerous FoCUS protocols have been offered in the literature in order to standardise the procedure. In daily practice, collection of data depends on the goal of imaging rather than on a specific protocol due to the variability of clinical scenarios.

**Prospects of focus echocardiography development in Russia**

While FoCUS is a simplified variant of ultrasound imaging with a limited protocol, it is an optimal modern method of clinical examination by a medical doctor.

In reality, cardiologists, general practitioners, anaesthesiologists and resuscitation specialists often use a limited ultrasound protocol in daily practice. Some studies have shown that a short training is enough to perform FoCUS and interpret its results. Consistency of FoCUS and standard echocardiography results is satisfactory, performance of the trainee improves within a short period of time and variability of observers is low [14-16].

European guidelines regarding cardio-visualisation declare training to use mobile ultrasound systems (see Figure 2) for students, young specialists and specialists seeking to enhance their competencies as one of the goals. The training is performed with a teacher controlling appropriate acquisition of the image. At first, interpretation of the data is discussed together with consequent transition of each operator to self-standing acquisition and interpreting of the data.

Specific education and training to use mobile devices is achieved through individual interpretation of 25-50 examinations [15]. At present, focus echocardiography educational programmes are being introduced into the National Medical Research Center for Preventive Medicine of the Ministry of Healthcare of the Russian Federation.



**Figure 1.** A mobile ultrasound device used by an admitting general practitioner in the setting of a city clinical hospital



**Figure 2.** A mobile ultrasound system general practitioner in the setting of a city clinical hospital

## Conclusion

Application of mobile ultrasound devices has completely changed the approach to management of cardiovascular patients.

Portable devices make it possible to obtain basic information regarding morphology of the heart and its function in both haemodynamically stable and unstable patients. They enhance physical examination through a short and simplified focus ultrasound protocol aimed at achievement of rapid diagnostics, early treatment and basic monitoring of cardiovascular diseases.

It is a limited method, but it is fast, reproducible and simply performed. The training is short (although highly information-bearing) and can be used for doctors in different specialties. The FoCUS is not to be considered

a replacement for echocardiographic examination but a clinical tool analogical to a stethoscope for early diagnosis (at the patient's bedside), determining of aetiology and pathophysiology of the event and prognostic stratification. In certain clinical situations, routine usage of mobile ultrasound is immensely useful.

## Conflict of Interest Statement

This article did not receive any external funding. Therefore, it is declared that there is no conflict of interest regarding this particular paper.

## References

1. Cardim N, Dalen H, Voigt JU, Ionescu A, Price S, Neskovic AN, et al. The use of handheld ultrasound devices: A position statement of the European Association of Cardiovascular Imaging (2018 update). *Eur Heart J Cardiovasc Imaging*. 2019;20(3):245–52. <https://doi.org/10.1093/ehjci/jey145>
2. Mitchell C, Rahko PS, Blauwet LA, Canaday B, Finstuen JA, Foster MC, et al. Guidelines for Performing a Comprehensive Transthoracic Echocardiographic Examination in Adults: Recommendations from the American Society of Echocardiography. *J Am Soc Echocardiogr*. 2019;32(1):1–64. <https://doi.org/10.1016/j.echo.2018.06.004>
3. Douglas PS, Khandheria BJ, Stainback RF. ACCF/AHA/ACEP/ASNC/SCAI/SCCT/SCMR 2007 appropriateness criteria for transthoracic and transesophageal echocardiography: A report of the American College of Cardiology Foundation Quality strategic directions committee appropriateness criteria working group, American Society of Echocardiography, American College of Emergency Physicians, American Society of Nuclear Cardiology, Society for Cardiovascular Angiography and Interventions, Society of Cardiovascular Computed Tomography, and the Society for Cardiovascular Magnetic Resonance. Endorsed by the American College of Chest Physicians and the Society of Critical Care Medicine. *J Am Coll Cardiol*. 2007;50(2):187–204. <https://doi.org/10.1016/j.jacc.2007.05.003>
4. Picard MH, Adams D, Bierig SM, Dent JM, Douglas PS, Gillam LD, et al. American Society of Echocardiography Recommendations for Quality Echocardiography Laboratory Operations. *J Am Soc Echocardiogr*. 2011;24(1):1–10. <https://doi.org/10.1016/j.echo.2010.11.006>
5. Razaak M, Martini MG, Savino K. A Study on Quality Assessment for Medical Ultrasound Video Compressed via HEVC. *IEEE J Biomed Health Inform*. 2014;18(5):1552–9. <https://doi.org/10.1109/JBHI.2014.2326891>
6. Martini MG, Iacobelli L, Bergeron C, Hewage CT, Panza G, Piri E, et al. Real-time multimedia communications in medical emergency—The CONCERTO project solution. In: *Proceedings of the 2015 37th Annual International Conference of the IEEE Engineering in Medicine and Biology Society (EMBC)*, Milan, Italy, 25–29 August 2015. Milan; 2015:7324–7. <https://doi.org/10.1109/EMBC.2015.7320083>
7. Di Bello V, La Carruba S, Conte L, Fabiani I, Posteraro A, Antonini-Canterin F, et al. Incremental value of pocket-sized echocardiography in addition to physical examination during inpatient cardiology evaluation: A multicenter Italian study (SIEC). *Echocardiography*. 2015;32:1463–70. <https://doi.org/10.1111/echo.12910>
8. Chamsi-Pasha MA, Sengupta PP, Zoghbi WA. Handheld Echocardiography: Current State and Future Perspectives. *Circulation*. 2017;136(22):2178–88. <https://doi.org/10.1161/CIRCULATIONAHA.117.026622>
9. Spencer KT, Kimura BJ, Korcarz CE, Pellikka PA, Rahko PS, Siegel RJ. Focused Cardiac Ultrasound: Recommendations from the American Society of Echocardiography. *J Am Soc Echocardiogr*. 2013;26(6):567–81. <https://doi.org/10.1016/j.echo.2013.04.001>
10. Nesković AN, Skinner H, Price S, Via G, De Hert S, Stanković I, et al. Focus cardiac ultrasound core curriculum and core syllabus of the European Association of Cardiovascular Imaging. *Eur Heart J Cardiovasc Imaging*. 2018;19(5):475–81. <https://doi.org/10.1093/ehjci/jey006>
11. Fukuda S, Shimada K, Kawasaki T, Fujimoto H, Maeda K, Inanami H, et al. Pocket-Sized Transthoracic Echocardiography Device for the Measurement of Cardiac Chamber Size and Function. *Circ J*. 2009;73(6):1092–6. <https://doi.org/10.1253/circj.cj-08-1076>
12. Culp BC, Mock JD, Chiles CD, Culp WC. The Pocket Echocardiograph: Validation and Feasibility. *Echocardiography*. 2010;27(7):759–64. <https://doi.org/10.1111/j.1540-8175.2009.01125.x>
13. Douglas PS, Garcia MJ, Haines DE, Lai WW, Manning WJ, Patel AR, et al. ACCF/AHA/ASNC/HFSA/HRS/SCAI/SCCM/SCCT/SCMR 2011 Appropriate use criteria for echocardiography. *J Am Soc Echocardiogr*. 2011;24(3):229–67. <https://doi.org/10.1016/j.echo.2010.12.008>
14. Panoulas VF, Daigeler AL, Malaweera AS, Lota AS, Baskaran D, Rahman S, et al. Pocket-size hand-held cardiac ultrasound as an adjunct to clinical examination in the hands of medical students and junior doctors. *Eur Heart J Cardiovasc Imaging*. 2013;14(4):323–30. <https://doi.org/10.1093/ehjci/jes140>
15. Alexander JH, Peterson ED, Chen AY, Harding TM, Adams DB, Kisslo JA. Feasibility of point-of-care echocardiography by internal medicine house staff. *Am Hear J*. 2004;147(3):476–81. <https://doi.org/10.1016/j.ahj.2003.10.010>
16. Ryan T, Berlacher K, Lindner JR, Mankad SV, Rose GA, Wang A. COCATS 4 task force 5: Training in echocardiography: Endorsed by the American Society of Echocardiography. *J Am Soc Echocardiogr*. 2015;28(6):615–27. <https://doi.org/10.1016/j.echo.2015.04.014>

# ATRIAL FLUTTER AS THE FIRST MANIFESTATION OF PROGRESSIVE CARDIAC CONDUCTION DISEASE IN A YOUNG APPARENTLY HEALTHY PATIENT: A CASE REPORT

I. Stepanenko<sup>1</sup>, D. Frolov<sup>1</sup>, V. Salukhov<sup>1</sup>, M. Didenko<sup>2</sup>, V. Kitsyshin<sup>1</sup>, Z. Khalaeva<sup>1</sup>, S. Kushnarev<sup>3</sup>

<sup>1</sup>Molchanov First Department of Internal Medicine Postgraduate Training, Kirov Military Medical Academy, Saint Petersburg, Russian Federation

<sup>2</sup>Kupriyanov First Department of Postgraduate Surgical Training, Kirov Military Medical Academy, Saint Petersburg, Russian Federation

<sup>3</sup>Radiology Department, Kirov Military Medical Academy, Saint Petersburg, Russian Federation

## Abstract

We reported a case of a twenty-one-year-old man with an atrial flutter as the first manifestation of progressive cardiac conduction disease. The patient was admitted to the cardiology department due to complaints of shortness of breath and a decrease in exercise tolerance, which had happened after physical exercises (running). During ambulatory ECG monitoring persistent AFL was observed with atrial rate 262-297 bpm and ventricular rate 26-136 bpm (average 56 bpm). AV conduction was very variable – 4:1-14:1. The results of ambulatory ECG monitoring during the whole period of recording indicated signs of atrioventricular conduction disturbances. After cardioversion sinus rhythm was restored additional rhythm and conduction disorders were revealed. Ambulatory ECG monitoring was performed two weeks after the initial one, and throughout this recording were registered sinus rhythm on the background of first-degree AV block; transient Mobitz I AV block; and type 2 second-degree sinoatrial block. Trans-esophageal electrophysiology study was performed. During pharmacological denervation of the heart, signs of slowing of the atrioventricular conduction and sinus node recovery time persisted. These changes along with right bundle branch block were regarded as a progressive cardiac conduction disease with an apparently hereditary cause.

## Keywords

*progressive cardiac conduction disorder • atrial flutter • Lev-Lenegre disease • young patient*

## Introduction

Progressive cardiac conduction disease (PCCD) is a hereditary, potentially life-threatening [1] heart disease that is often primarily a genetic disease, but may also be associated with structural heart disease [2–4]. In this article, we report PCCD with atrial flutter (AFL) as a manifestation. To our knowledge, there is only one similar case report, which has been presented in the available literature [5].

## Case report

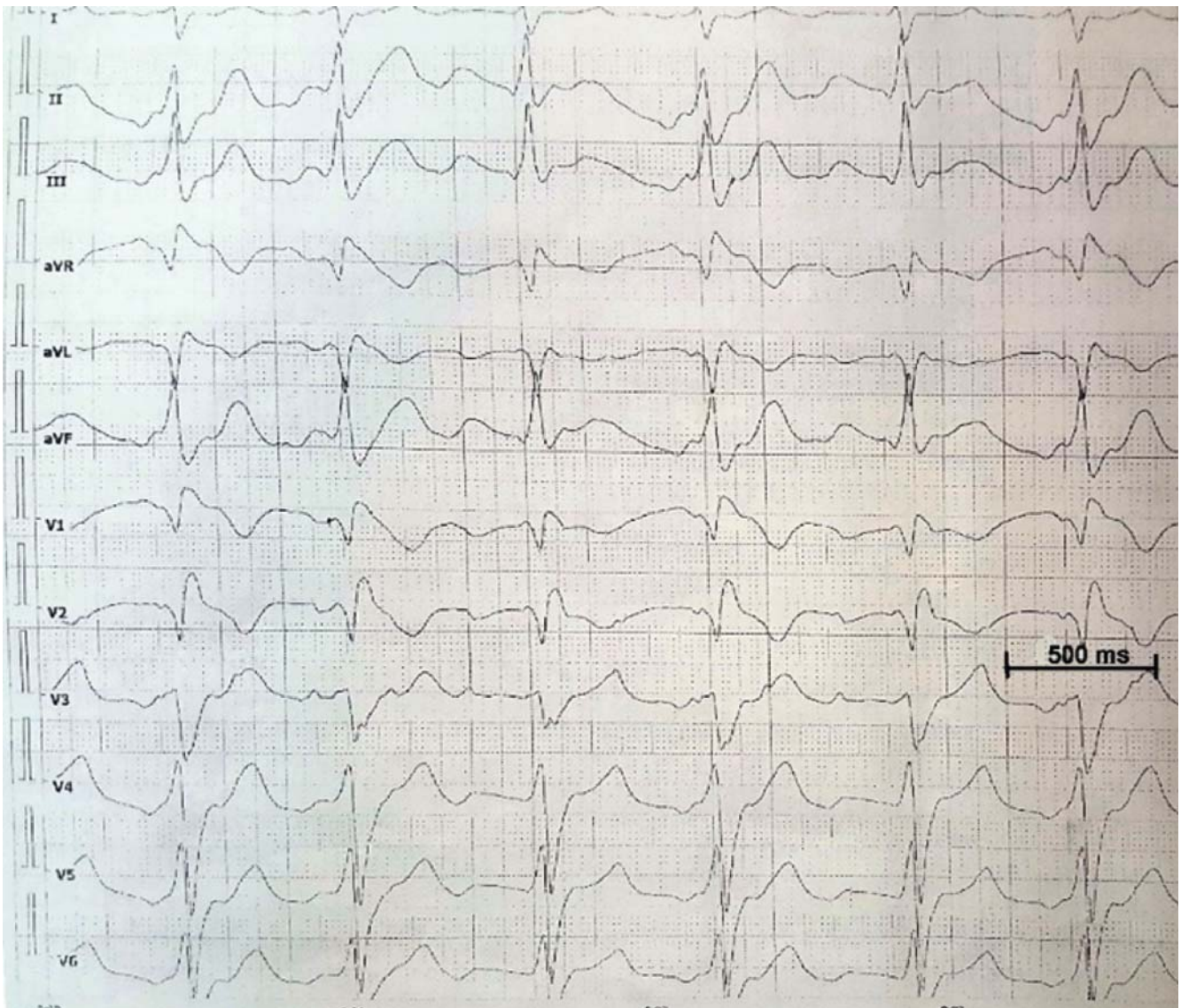
A young, apparently healthy twenty-one-year-old man was admitted to the cardiology department due to complaints of shortness of breath and a decrease in exercise tolerance, which had happened after physical exercises (running). The patient's father died due to sudden cardiac death at

the age of 47 years. The physical examination revealed accelerated heart rate (102 bpm) and normal blood pressure. Examination of other organs and systems were without apparent pathology.

On admission to the cardiology department, the electrocardiogram (ECG) showed AFL with pretty regular ventricular rate, (98 bpm), right axis deviation, complete right bundle branch block (RBBB), left posterior fascicular block (LPFB). (Figure 1). Complete blood count showed an increase in the hemoglobin level to 167 g/L, in the biochemical blood analysis, the CPK level exceeded the upper limit of reference values (221.02 U/L), while the CPKMB level was normal. Other biochemical blood parameters were normal. Thyroid function was not impaired.

The echocardiography showed mild mitral regurgitation. The sizes and function of ventricles as well as thickness





**Figure 1.** 12-Lead ECG on admission (paper speed 50 mm/s) with AFL with pretty regular ventricular rate (98 bpm), right axis deviation, complete RBBB, LPFB. AFL, atrial flutter; RBBB, right bundle branch block; LPFB, left posterior fascicular block.

of myocardium were normal. Late gadolinium-enhanced cardiac magnetic resonance revealed no evidence of any specific pathologic abnormality including diagnostic features associated with cardiomyopathy or/and inflammation, such as myocardial edema, global hypermedia, and focal necrosis, fibrosis, scar, etc. Similarly, chest computed tomography revealed no abnormality.

During ambulatory ECG monitoring persistent AFL was observed with atrial rate 262-297 bpm and ventricular rate 26-136 bpm (average 56 bpm). AV conduction was very variable – 4:1-14:1. (Figure 2A). 74 pauses (more than 2500 msec) were recorded with maximum duration – 3107 msec (without clinical symptoms). The results of ambulatory ECG

monitoring during the whole period of recording indicated signs of atrioventricular conduction disturbances. Abdominal and thyroid ultrasound revealed no pathology.

The patient was successfully cardioverted by 50 J biphasic electrical cardioversion. After a short period of bradyarrhythmia (junctional rhythm 45 bpm, then accelerated junctional rhythm with atrioventricular (AV) dissociation 55-60 bpm) which required an additional 0.1% atropine (1.0 ml) administration, 76 bpm sinus rhythm was restored. The patient received anticoagulant therapy with Rivaroxaban 20 mg once daily before cardioversion (11 days) and 6 weeks afterwards.

According to the ambulatory ECG monitoring repeated two weeks after the initial one, throughout this recording were

registered sinus rhythm on the background of first-degree AV block (Figure 2B); transient Mobitz I AV block (Figures 2C); and type 2 second-degree sinoatrial block (Figure 2D).

A trans-esophageal electrophysiology study was performed. Sinoatrial conduction time (SACT) was 316 msec; maximal SNRT 1587 msec; rate-corrected sinus node recovery time (CSNRT) 712 msec; Wenckebach point was 120 impulses per minute. The effective refractory period (ERP) of the AV node was 400 msec (normal range 280–320 msec). After 3 minutes on the background of pharmacological denervation of the heart, a sinus rhythm with a heart rate of 78 bpm (<80% of the proper value) was recorded; maximum SNRT was 1370 msec; CSNRT 594 msec; Wenckebach point was 130 impulses per minute; ERP of the AV node 360 msec. It was not possible to induce any tachyarrhythmias during programmed stimulation. Conclusion: during pharmacological denervation of the heart, signs of slowing of the atrioventricular conduction and sinus node recovery time persisted.

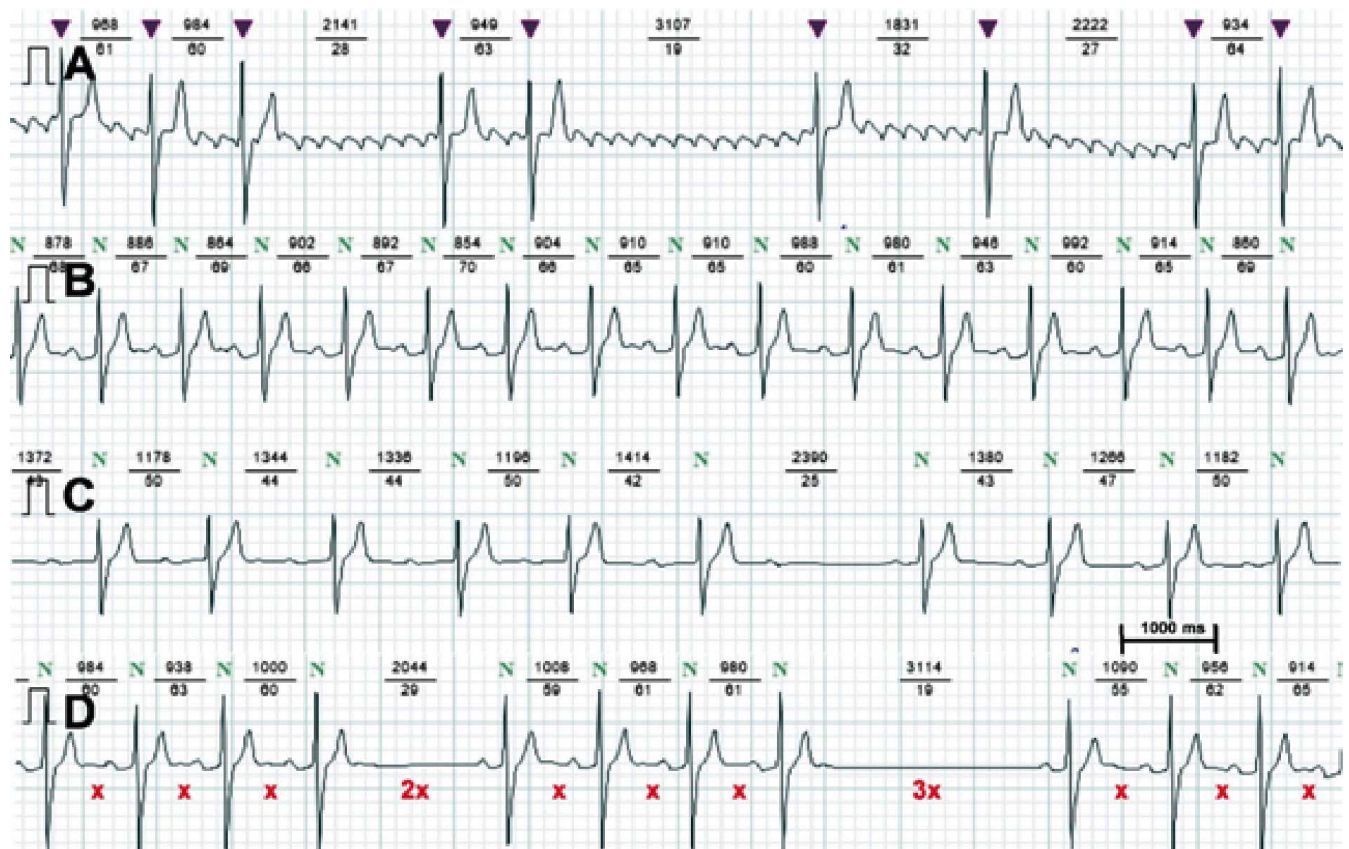
Genetic testing was not available at the time of patient hospitalization.

Thus, the following diagnosis was made: primary progressive cardiac conduction disease (PCCD) with sick sinus syndrome in the form of transient second-degree sinoatrial block type 2 and paroxysmal AFL; conduction disturbance in the form of a permanent first-degree AV block; transient second-degree AV block type 1; complete right bundle branch block and left posterior fascicular block; without heart failure.

The patient was discharged without health complaints, and with the recommendations to repeat ambulatory ECG monitoring and to be under cardiologist observation.

## Discussion

Along with the progressive delay of impulse conduction through the His-Purkinje system, atrioventricular block, right or left bundle branch block (RBBB or LBBB), and development of syncopal states, PCCD can lead to such fatal consequences as sudden cardiac death [6]. In this regard, especially if the



**Figure 2.** Ambulatory ECG monitoring before (A) and after (B,C,D) cardioversion (speed of recordings 12.5 mm/s). (A) AFL with 4:1-14:1 AV conduction. (B) First-degree AV block. C. Second-degree AV block type 1. (D) Type 2 second-degree sinoatrial block. AFL, atrial flutter; AV, atrioventricular.



patient has a family history of sudden death of first-degree relatives, the presence of signs of PCCD dictates the need to assess risks for the patient and determine the tactics of observation and treatment, including the consideration of pacemaker (PM) implantation [7].

AFL, which was the direct cause of the patient's admission to the hospital, is rare at a young age, and has the most common association with structural heart diseases, including rheumatic heart disease, inherited pathology, and various forms of cardiomyopathy. Despite the fact that according to a number of studies, the risk of thromboembolism in AFL is relatively low [8], the recovery of sinus rhythm in young patients is preferred [9]. Successful cardioversion in this clinical case also allowed us to study in detail the status of the cardiac conduction system of the patient.

Anamnesis (the father died from sudden cardiac death) suggests that the pathology seems to be hereditary. In this regard, the question of the need for genetic testing was raised, but according to the current HRS/EHRA Expert Consensus Statement on the State of Genetic Testing for the Channelopathies and Cardiomyopathies, genetic testing has the recommendation class IIb (may be considered) [10]. The prerequisite for conducting a genetic examination in this

case would be the presence of concomitant hereditary heart disease, which was not confirmed during a comprehensive examination of the cardiovascular system.

The rare case presented here demonstrated that PCCD can manifest with supraventricular arrhythmia, which has become an independent factor in the deterioration of the patient's well-being. Given that the disease has a progressive development, such patients should be closely monitored by a cardiologist, so that when the indications appear, the implantation of a pacemaker and the catheter ablation of the atrial flutter may be done in a timely manner.

### Conflict of interest

Authors declare no conflict of interests for this article

### ORCID

Ivan A. Stepanenko <https://orcid.org/0000-0001-6436-5656>

### References

1. Michaëlsson M, Jonzon A, Riesenfeld T. Isolated congenital complete atrioventricular block in adult life. A prospective study. *Circulation*. 1995;92(3):442–9. <https://doi.org/10.1161/01.cir.92.3.442>
2. Asatryan B, Medeiros-Domingo A. Molecular and genetic insights into progressive cardiac conduction disease. *Europace*. 2019;21(8):1145–58. <https://doi.org/10.1371/journal.pone.0174434>
3. Baruteau A-E, Probst V, Abriel H. Inherited progressive cardiac conduction disorders. *Curr Opin Cardiol*. 2015;30(1):33–9. <https://doi.org/10.977/HCO.0000000000000134>
4. Kiselev A, Mikhaylov E, Parmon E, Sjoberg G, Sejersen T, Tar-novskaya S, et al. Progressive cardiac conduction disease associated with a DSP gene mutation. *Int J Cardiol*. 2016;216:188–9. <https://doi.org/10.1016/j.ijcard.2016.04.164>
5. Hothi SS, Ara F, Timperley J. p.Y1449C SCN5A mutation associated with overlap disorder comprising conduction disease, Brugada syndrome, and atrial flutter. *J Cardiovasc Electrophysiol*. 2015;26(1):93–7. <https://doi.org/10.1111/jce.12470>
6. Lynch HT, Mohiuddin S, Sketch MH, Krush AJ, Carter S, Runco V. Hereditary progressive atrioventricular conduction defect. A new syndrome? *JAMA*. 1973;225(12):1465–70. <https://doi.org/10.1001/jama.1973.03220400011003>
7. Schott J-J, Charpentier F, Marec HL. Progressive Cardiac Conduction Disease. In: Gussak I, Antzelevitch C, Wilde AAM, Friedman PA, Ackerman MJ, Shen W-K, editors. *Electrical Diseases of the Heart: Genetics, Mechanisms, Treatment, Prevention*. London: Springer; 2008. p. 564–76. [https://doi.org/10.1007/978-1-84628-854-8\\_39](https://doi.org/10.1007/978-1-84628-854-8_39)
8. Ghali WA, Wasil BI, Brant R, Exner DV, Cornuz J. Atrial flutter and the risk of thromboembolism: a systematic review and meta-analysis. *Am J Med*. 2005;118(2):101–7. <https://doi.org/10.1016/j.amjmed.2004.06.048>
9. Mont L. 'Fight for sinus rhythm, or surrender?'.... *Eur Heart J*. 2014;35(22):1427–9. <https://doi.org/10.1093/eurheartj/ehu099>
10. Ackerman MJ, Priori SG, Willems S, Berul C, Brugada R, Calkins H, et al. HRS/EHRA expert consensus statement on the state of genetic testing for the channelopathies and cardiomyopathies: this document was developed as a partnership between the Heart Rhythm Society (HRS) and the European Heart Rhythm Association (EHRA). *Europace*. 2011;13(8):1077–109. <https://doi.org/10.1093/europace/eur245>

# THE INCIDENCE OF DEPRESSION AND THE DECREASE OF QUALITY OF LIFE IN PATIENTS WITH MODERATE-SEVERE INFLAMMATORY ACNE

C.A. Verdeja-Robles<sup>1</sup>, C.E. Velazquez-De la Rosa<sup>1</sup>, A. Gutiérrez-Morgas<sup>1</sup>

<sup>1</sup>Universidad Popular Autónoma del Estado de Puebla (UPAEP); Clínica Médica Universitaria, Puebla, México

## Abstract

**Objective:** to know the prevalence of depression in patients with moderate-severe acne vulgaris.

**Hypothesis:** the incidence of depression increases in patients with moderate-severe acne vulgaris and will therefore decrease the quality of life.

**Background:** acne is a very frequent dermatosis in the outpatient clinic, it is not considered a life-threatening disease. It has been associated with negative emotional status. Also, suffering from it for a long time has been associated with depression, anxiety and frustration. The complications of acne in the psychosocial aspect are related to academic or vocational performance, self-esteem and adolescents' quality of life.

**Materials and Methods:** the type of study was retrospective cross-sectional descriptive observational study. The sampling was carried out at the facilities of the Popular Autonomous University of the State of Puebla, taking into account any person within the institutional organisation within the range of 12-20 years of age, with a total of 50 participants. The Hamilton assessment scale of depression and the Cardiff Acne disability index were applied to all patients with dermatological diagnosis of moderate-severe vulgar acne in a period between February-October 2019.

**Results:** a total of 50 patients were analysed, of which 28 were women aged 12 to 20 years and 22 men (28 women and 13 men) and severe acne in 9 patients, all over 17 years of age and male. According to the degree of depression, 28% (n = 14) of the patients were obtained without some degree of depression; 60% (n = 30) with minor depression; 12% (n = 6) with moderate depression. Regarding the quality of life: 40% (n = 20) of the patients showed good quality of life, 46% (n = 23) regular quality of life and 14% (n = 7) showed poor quality of life.

**Conclusion:** orderly study of the psychic impact of acne and other skin diseases on people suffering them is recent and is carried out through questionnaires that try to measure the impact the diseases have on the patients' quality of life.

## Keywords

acne vulgaris • disease • skin • impact • self-esteem • psychological • isolation • dermatological • appearance

## JUSTIFICATION AND PROPOSAL APPROACH

- What is the prevalence of depression in patients with moderate-severe acne vulgaris?
- How much does moderate-severe acne vulgaris affect the patient's life quality?

## HYPOTHESIS

- The incidence of depression increases in patients with moderate-severe acne vulgaris and will therefore decrease life quality

## OBJECTIVES

- General objective: to know the prevalence of depression in patients with moderate-severe acne vulgaris

- Specific objectives: to determine the relationship between depression and decreased life quality in patients with moderate-severe acne vulgaris

## Introduction

Acne is a very frequent dermatosis in the outpatient clinic and is not considered a life-threatening disease. However, it is associated with negative emotional burden and its long-term progression has been associated with depression, anxiety and frustration. This results in poor quality of life when the patient does not receive treatment at early stages.

Depression is a syndrome that manifests in emergence of affective symptoms (pathological sadness, decay, irritability, subjective feeling of discomfort and impotence in the face of life's demands) and symptoms of cognitive, volitional or even somatic type. There is deterioration in appearance and personal appearance, slow movements, low tone of voice, sad or poor facial expression, easily evoked or spontaneous crying, low concentration, pessimistic ideation, hypochondriac complaints, alterations in the sleep rhythm. In addition, the emotional climate in the family and the patient's social and economic situation should be considered. Depression affects 350 million people around the world and, usually beginning at young ages, it is among the leading disabling diseases and has become a priority target of care worldwide [1-4].

Quality of life is defined as the "individual's perception of their position in life in the context of the culture and value system in which they live and in relation to their objectives, expectations, standards and concerns" (1994). Today, the quality of life related to healthcare can be understood as values related to health, disease and treatment outcomes. It is also a dynamic and changing process that includes continuous interactions between the patient and their environment [4, 5].

Values of health-related quality of life measured through scales help healthcare personnel identify and assess the effect of the disease on the individual's daily life activities. Application of such studies on treatment and quality of life in dermatology is recent. However, it is particularly interesting in this field as skin diseases generally have strong effects on social relationships, psychological status and daily life activities [6-8].

Acne vulgaris is a chronic inflammatory disease of the pilosebaceous unit. It is a worldwide dermatosis. In this context, it is estimated that within 9.4% of the population affected by this disease, the groups with the highest incidence are adolescents and young adults. Such individuals have had acne before the age of 21 in 80-90% of the cases. In addition, it constitutes one of the most common dermatological diagnoses.

The pathogenic factors involved are increase in sebum production by the sebaceous glands, alterations in keratinization, colonization by *Propionibacterium acnes* and activation of innate immunity followed by increase of inflammatory factors.

In clinical terms, signs of non-inflammatory acne include seborrhea, comedones with closed and open heads. The inflammatory acne has papular, pustular and cystic lesions which, in turn, are divided into Ibero-Latin American grades published in 2014. The grades are mild, moderate and severe [9-12].

Topical medications are the mainstay of mild-to-moderate acne treatment. The most prescribed ones are retinoids, such as tretinoin, adapalene and tazarotene. They are considered

as penetration facilitators for other topical medications and decrease free fatty acids in microcomedones. Benzoyl peroxide has keratolytic and antimicrobial effects on strains of *Propionibacterium acnes* [13, 14].

Systemic retinoids, such as isotretinoin, have keratolytic and anti-inflammatory effectiveness. However, they are contraindicated during pregnancy due to their teratogenicity. The duration of treatment is usually up to 24 weeks depending on the severity of the acne or its relationship with concomitant diseases, such as polycystic ovarian syndrome in the case of female patients. Systemic antibiotics (doxycycline, minocycline, clindamycin, trimethoprim with sulfamethoxazole or erythromycin) reduce colonization of *Propionibacterium acnes*. Oral contraceptives are part of acne treatment for women as long as their prescription is not contraindicated [15].

Complications of acne in the psychosocial aspect are related to academic or vocational performance, self-esteem and teenagers' quality of life. Recently, some research have given greater weight to the study of emotional and psychosocial effects of acne despite the enormous work done to determine pathophysiology, risk factors and acne treatment.

Regarding life quality, some authors compare acne with chronic diseases, such as asthma, epilepsy, diabetes, low back pain, arthritis and coronary ischemic disease due to its great psychological effects on those suffering from them.

Disability in terms of quality of life in acne is considered in accordance with the severity of deteriorations assessed in quality of life and results in low self-esteem, isolation and restriction of activities.

Self-esteem is favorable or unfavorable attitude towards oneself. Currently, assessment of self-esteem is very relevant in the social context, especially for those who live relying on appearance and body image. In teenagehood, this social pressure regarding physical appearance is very intense, thus they live to be accepted in the standards that society itself dictates, whether with school groups, friends, social networks or even family.

Acne is also accompanied by feelings of shame, depression, negative self-attitude or physical appearance and poor satisfaction with one's own body image [16]. A British study that recruited adults with dermatosis improved patients' self-esteem by prescribing isotretinoin. It was concluded in this study that acne treatment should be adequate in time and quality to avoid psychosocial complications [17].

Therefore, the Cardiff Acne Disability Index (CADI) was developed. It features understandable language and few points to assess, designed to be easily answered by the patient [18-20]. It is necessary to study the psychosocial effect and quality of life in young people with acne using validated and age-appropriate measures [21].

## Materials and Methods

Study type: Retrospective cross-sectional descriptive observational study

Population and sample: The sampling will be carried out at the facilities of the Popular Autonomous University of the State of Puebla, taking into account any person who is within the institutional organizational chart (students, teachers, administrative, surveillance and maintenance personnel) that are between the range of 12-20 years of age, with a total of 50 participants.

Inclusion criteria:

- Age between 12 and 20 years old
- Students or professors of the UPAEP who come as patients to the CMU
- Patients with moderate-severe inflammatory acne vulgaris

Exclusion criteria

- Patients > 20 years old
- Patients outside the UPAEP university community

Process:

The Hamilton assessment scale of depression and the Cardiff Acne disability index were applied to all patients with dermatological diagnosis of moderate-severe vulgar acne within the period of February-October 2019.

## Results

A total of 50 patients were analyzed, including 28 women and 22 men aged 12 to 20 years (28 women and 22 men). Severe acne was registered in 9 patients; all over 17 years of age and male (see Figure 1).

According to the degree of depression, 28% (n = 14) of the patients were observed to have any degree of depression; 60% (n = 30) with minor depression; 12% (n = 6) with moderate depression (see Figure 2).

Regarding the life quality: 40% (n = 20) of the patients showed good life quality, 46% (n = 23) regulate quality of life and 14% (n = 7) poor life quality (see Figure 3).

## Discussion

In this study, the majority of patients were female (56%), which does not coincide with what was reported by Santamaría-González and Valdés-Webster as acne was more frequent in men in that study. However, both studies

## PATIENTS BY GENDER

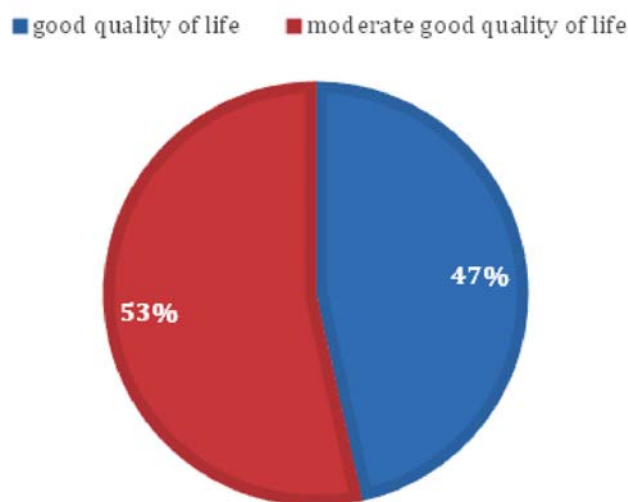


Figure 1. Patients by gender

agree that the perception of quality of life was better and studies compared subjects with and without acne with lower perception of life quality. In our study, we did not compare healthy and sick subjects with acne, but only patients with acne [21].

In another study in Malaysia with more than 400 patients found a higher prevalence of acne in male patients and our study in female patients. In that study, the authors used CADL, with results similar to ours in terms of quality of life in patients with acne because they associated poor quality of life in patients with more severe acne [22].

In more recent reviews, we found that there were 200 teenagers with acne evaluated using four measurements in a Nigerian study. These were clinical degree and severity of acne, CADL, RSES self-esteem assessment (Rosenberg self-esteem scale). It was highlighted in their results that the quality of life was affected generating shame, frustration and aggressive attitude as their consequence. They concluded that the more severe the acne and residual spots are, the worse the quality of life of teenagers is [23-25].

Also, in a Turkish case-control study they used the global system to stage acne (global acne grading system), the dermatological quality of life index for children, the pediatric quality of life questionnaire (PedsQL, pediatric quality of life questionnaire) where their results and conclusion were that the SQD between the genders of the case and control group and also found no notable differences between the severity of acne and psychosocial changes. [26-27].

## INCIDENCE OF DEPRESSION

■ good quality of life   ■ moderate good quality of life   ■ poor quality of life

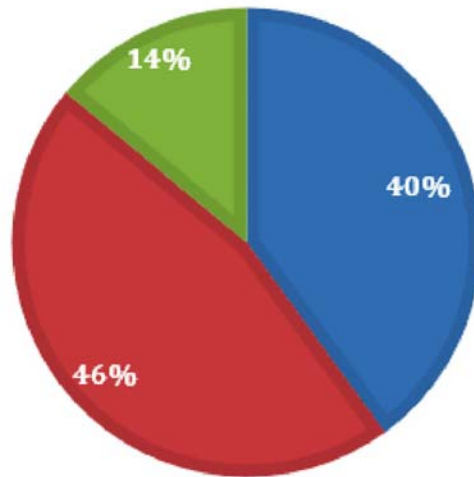


Figure 2. Incidence of depression

## QUALITY OF LIFE

■ good quality of life   ■ moderate good quality of life   ■ poor quality of life

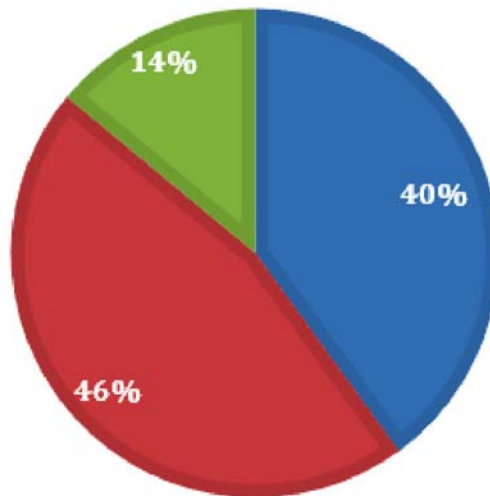


Figure 3. Quality of life

### Conclusion

The ordered study of the psychic impact of acne and other skin diseases on people who suffer from them is recent and is carried out through questionnaires that try to measure the impact it has on the patient's quality of life

Acne is a very frequent disease in our daily practice, where we face the cutaneous manifestation, but also with the psychic repercussion that it has on each patient and teaches us that we must be successful in terms of treatment.

Depression and quality of life in patients with acne are directly related to the administration of opportune and effective treatment.

Specifically, it is concluded that in this patients group with inflammatory acne, depression and quality of life are directly affected by the underlying disease, so that with these

clinical tools primary care doctors can provide patients with comprehensive management by promoting healthy practices, primary prevention and opportune referral to dermatologists in severe cases or poor response to treatment.

### Conflict of Interest Statement

The authors do not have any conflict of interest.

### References

- Shoshana B, María AL, Rebeca R. Depresión: Knowledge status and the necessity of public politics and action plans in Mexico. *Salud Pública Mex* 2013;55:74-80.
- Birmaher B, Ryan ND, Brent D, Kaufman J et al. Childhood and adolescent depression: A review of the past ten years. Part 1. *J Am Child Adolesc Psychiatry*. 1996;35:1427-1439.
- García-Herrera P, Nogueras , Muñoz C. Clinical practice guide for the treatment of depression in first contact attention. *Distrito Sanitario Málaga UCG Salud Mental Hospital Regional Universitario Carlos Haya Málaga* 2011;47-49.
- Romero-Márquez R, Romero-Zepeda H. Healthcare related quality of life reflections. *Rev Med Inst Mex Seguro Soc* 2010;48(1):91-102.
- Schwartzmann L. Healthcare related life quality: conceptual aspects. *Science and nursing (Mexico)* 2003;2:9-21
- Quintero C, Lugo L, García H, Sánchez A. Kidscreen questionnaire validation of quality of life in children and teenager health from Medellín, Colombia. *Revista Colombiana de Psiquiatría* 2011;40(3):470-487.
- Halioua B, Beaumont MG. Quality of life in dermatology. *Int J Dermatol* 200;39:801-806
- Casas L. Teenager's life quality. *Revista cubana de pediatría* 2010;82(4): 112-6.
- Argote A, Mora O, Gonzalez L, Zapata J. Physiopathological aspects of acne. *Rev Asoc Colomb Dermatol* 2014;22:200-208.
- Tompson A. Acne. *JAMA* 2012;313(6):640-641.
- Bhambri S, Del Rosso JQ. Pathogenesis of acne vulgaris: recent advances. *J drugs dermatol* 2009;8:615-618
- Kaminsky A, Florez-White M, Arias MI. Acne classification: Ibero-american consensus, 2014. *Med cutan iber lat am* 2015;43(1):18-23.
- Orozco B, Campo ME, Anaya LA et al. Colombian guides for the treatment of acne: a revision based in evidence by the Colombian group of Acne studies. *Rev Asoc Colomb Dermatol* 2011;19:129-158.
- Ortiz SD, Toledo BM. Clinical practice guide: summary of evidences and recommendations: diagnosis and treatment of acne. *Ciudad de Mexico SSA-224-09:2009;35-35*
- Del Rosso JQ, Leyden JJ. Status report on antibiotic resistance: implications for dermatologist. *Dermatol Clin*. 2007;25:127-32.
- Kameran H, Bilal M. Quality of life in patients with acne in Erbil city. *Health and Quality of life Outcomes* 2012;10:1-4.
- Kallet SC, Gawkrödger DJ. The psychological and emotional impact of acne and the effect of treatment with isotretinoin. *Br J Dermatol* 1999;140:273-282.
- Purrifios M; Hamilton Depression Rating Scale. *Servizo de Epidemiologia. Dirección Xeral de Saúde Pública. Disponible en: <http://www.meiga.info/escalas/depresion-Escala-Hamilton.pdf>*
- Bobes J, et al. Comparative psychometric evaluation from Spanish versions of 6, 7, 21 items from Hamilton valuation scale for the evaluation of depression *med clin* 2003;120(18):693-700.
- Ramos-Brieva J, Cordero A. Validation of the Spanish version of Hamilton's scale for depression *Actas Luso-esp neurol psiquiatr* 1986;14:324-334.
- Santamaría-Gonzalez V, Valdés-Webster RL. Juvenile inflammatory acne. *Evaluación de la calidad de vida con la encuesta. Rev Cent Dermatol Pascua* 2007;16:7-13.
- Arshad H, Khairani O, Samsul A. Prevalence of acne and its impact on the quality of life in school-aged adolescents in Malaysia. *J Prim Health Care* 2009;1:20-25.
- Rubio-García L, Pulido-Díaz N, Jimenez-Lopez JL. Isotretinoin and the depression symptoms in patients with severe and recurrent acne. *Rev Med Inst Mex Seguro Soc* 2015;53:54-59.
- Jelena P, Natasa M, Janki J, et al. Prevalence and quality of life in high school pupils with acne in Serbia. 2013;70(10):935-939
- Oladayo AA, Ifeanyi EO, Olatunde OF, Muphy OM, et al. The impact of acne and facial post-inflammatory hyperpigmentation on quality of life and self-esteem of newly admitted Nigerian Undergraduates. *Clin Cosmetic Investig Dermatol* 2018;11:245-252.
- Eyuboglu M, Kalay I. Evaluation of adolescents diagnosed with acne vulgaris for quality of life and psychosocial challenges. *Indian J Dermatol* 2018;63:131-135.
- Fabbroncini G, Cacciapouti S, Monfrecola. Qualitative Investigation of the impact of acne on health-related quality of life (HRQL): Development of Conceptual Model. *Dermatol Ther* 2018;8:85-99.



**Supplementary materials**

Annexed A. Hamilton Depression Rating Scale (HDRS)

**HAMILTON DEPRESSION RATING SCALE (HAM-D)**

(To be administered by a health care professional)

Patient Name \_\_\_\_\_

Today's Date \_\_\_\_\_

The HAM-D is designed to rate the severity of depression in patients. Although it contains 21 areas, calculate the patient's score on the first 17 answers.

**1. DEPRESSED MOOD**  
 (Gloomy attitude, pessimism about the future, feeling of sadness, tendency to weep)  
 0 = Absent  
 1 = Sadness, etc.  
 2 = Occasional weeping  
 3 = Frequent weeping  
 4 = Extreme symptoms

**2. FEELINGS OF GUILT**  
 0 = Absent  
 1 = Self-reproach, feels he/she has let people down  
 2 = Ideas of guilt  
 3 = Present illness is a punishment; delusions of guilt  
 4 = Hallucinations of guilt

**3. SUICIDE**  
 0 = Absent  
 1 = Feels life is not worth living  
 2 = Wishes he/she were dead  
 3 = Suicidal ideas or gestures  
 4 = Attempts at suicide

**4. INSOMNIA - Initial**  
 (Difficulty in falling asleep)  
 0 = Absent  
 1 = Occasional  
 2 = Frequent

**5. INSOMNIA - Middle**  
 (Complains of being restless and disturbed during the night. Waking during the night.)  
 0 = Absent  
 1 = Occasional  
 2 = Frequent

**6. INSOMNIA - Delayed**  
 (Waking in early hours of the morning and unable to fall asleep again)  
 0 = Absent  
 1 = Occasional  
 2 = Frequent

**7. WORK AND INTERESTS**  
 0 = No difficulty  
 1 = Feelings of incapacity, listlessness, indecision and vacillation  
 2 = Loss of interest in hobbies, decreased social activities  
 3 = Productivity decreased  
 4 = Unable to work. Stopped working because of present illness only. (Absence from work after treatment or recovery may rate a lower score).

**8. RETARDATION**  
 (Slowness of thought, speech, and activity; apathy; stupor.)  
 0 = Absent  
 1 = Slight retardation at interview  
 2 = Obvious retardation at interview  
 3 = Interview difficult  
 4 = Complete stupor

**9. AGITATION**  
 (Restlessness associated with anxiety.)  
 0 = Absent  
 1 = Occasional  
 2 = Frequent

**10. ANXIETY - PSYCHIC**  
 0 = No difficulty  
 1 = Tension and irritability  
 2 = Worrying about minor matters  
 3 = Apprehensive attitude  
 4 = Fears

## HAMILTON DEPRESSION RATING SCALE (HAM-D)

(To be administered by a health care professional)

- 11. ANXIETY - SOMATIC**  
 Gastrointestinal, indigestion  
 Cardiovascular, palpitation, Headaches  
 Respiratory, Genito-urinary, etc.  
 0 = Absent  
 1 = Mild  
 2 = Moderate  
 3 = Severe  
 4 = Incapacitating

- 12. SOMATIC SYMPTOMS - GASTROINTESTINAL**  
 (Loss of appetite, heavy feeling in abdomen; constipation)  
 0 = Absent  
 1 = Mild  
 2 = Severe

- 13. SOMATIC SYMPTOMS - GENERAL**  
 (Heaviness in limbs, back or head; diffuse backache; loss of energy and fatigability)  
 0 = Absent  
 1 = Mild  
 2 = Severe

- 14. GENITAL SYMPTOMS**  
 (Loss of libido, menstrual disturbances)  
 0 = Absent  
 1 = Mild  
 2 = Severe

- 15. HYPOCHONDRIASIS**  
 0 = Not present  
 1 = Self-absorption (bodily)  
 2 = Preoccupation with health  
 3 = Querulous attitude  
 4 = Hypochondriacal delusions

- 16. WEIGHT LOSS**  
 0 = No weight loss  
 1 = Slight  
 2 = Obvious or severe

- 17. INSIGHT**  
 (Insight must be interpreted in terms of patient's understanding and background.)  
 0 = No loss  
 1 = Partial or doubtful loss  
 2 = Loss of insight

**TOTAL ITEMS 1 TO 17:** \_\_\_\_\_

0 - 7 = Normal  
 8 - 13 = Mild Depression  
 14 - 18 = Moderate Depression  
 19 - 22 = Severe Depression  
 ≥ 23 = Very Severe Depression

- 18. DIURNAL VARIATION**  
 (Symptoms worse in morning or evening. Note which it is.)  
 0 = No variation  
 1 = Mild variation; AM ( ) PM ( )  
 2 = Severe variation; AM ( ) PM ( )

- 19. DEPERSONALIZATION AND DEREALIZATION**  
 (feelings of unreality, nihilistic ideas)  
 0 = Absent  
 1 = Mild  
 2 = Moderate  
 3 = Severe  
 4 = Incapacitating

- 20. PARANOID SYMPTOMS**  
 (Not with a depressive quality)  
 0 = None  
 1 = Suspicious  
 2 = Ideas of reference  
 3 = Delusions of reference and persecution  
 4 = Hallucinations, persecutory

- 21. OBSESSIVE SYMPTOMS**  
 (Obsessive thoughts and compulsions against which the patient struggles)  
 0 = Absent  
 1 = Mild  
 2 = Severe

\* Adapted from Hamilton, M. *Journal of Neurology, Neurosurgery, and Psychiatry*. 23:56-62, 1960.

# GLIOENDOCRINE SYSTEM: EFFECTS OF THYROID HORMONES IN GLIA AND THEIR FUNCTIONS IN THE CENTRAL NERVOUS SYSTEM

Mami Noda<sup>1</sup><sup>1</sup>Laboratory of Pathophysiology, Graduate School of Pharmaceutical Sciences, Kyushu University, Fukuoka, Japan

## Abstract

Glial cells play a significant role in the link between the endocrine and nervous systems. Among hormones, thyroid hormones (THs) are critical for the regulation of development and differentiation of neurons and glial cells, and hence for development and function of the central nervous system (CNS). THs are transported into the CNS, metabolized in astrocytes and affect various cell types in the CNS including astrocyte itself. Since 3,3',5-triiodo-L-thyronine (T3) is apparently released from astrocytes in the CNS, it is a typical example of glia-endocrine system.

The prevalence of thyroid disorders increases with age. Both hypothyroidism and hyperthyroidism are reported to increase the risk of cognitive impairment or Alzheimer's disease (AD). Therefore, understanding the neuroglial effects of THs may help to solve the problem why hypothyroidism or hyperthyroidism may cause mental disorders or become a risk factor for cognitive impairment. In this review, THs are focused among wide variety of hormones related to brain function, and recent advancement in gliohormone system is described.

## Keywords

thyroid hormone • aging • microglia • astrocytes • oligodendrocyte

## Abbreviations

AD.....	Alzheimer's disease	Hr .....	Hairless
AHDS.....	Allan-Herndon-Dudley syndrome	IFN-γ.....	interferon-gamma
Akt .....	Serine/threonine kinase	iNOS .....	Inducible NO synthase
albumin D-box .....	D site of albumin promoter	KLF9.....	Kruppel-like factor 9
BBB .....	Blood brain barrier	LAT .....	L-type amino acid transporters
BHLHe22 .....	Basic helix-loop-helix family member e22	MAPK/ERK .....	Mitogen-activated protein kinase/ extracellular signal-regulated kinase
CSF .....	Cerebrospinal fluid	MBP.....	Myelin basic protein
CKI .....	Cyclin-dependent kinase inhibitor	MCT8.....	Monocarboxylate transporters 8
cGMP.....	Cyclic guanosine phosphate	MOG .....	Myelin/oligodendrocyte glycoprotein
D2.....	Type 2-deiodinase	Ncoa1 .....	Nuclear coactivator 1
D3.....	Type 3-deiodinase	Ncor1 .....	Nuclear corepressor 1
DBP .....	Albumin D box-binding protein	NO .....	Nitric oxide
FAO .....	Fatty acid oxidation	OATPs.....	Organic anion-transporting polypeptides
GS .....	Glutamine synthetase	OPCs.....	Oligodendrocyte precursor cells
NA .....	Noradrenaline	p27.....	p27/Kip1
CNS .....	Central nervous system	p18.....	p18/INK
GFAP .....	Glial-fibrillary acidic protein	PI3K.....	Phosphoinositide 3-kinase
HADHA .....	Hydroxyacyl-CoA dehydrogenase/ 3-ketoacyl-CoA thiolase/enoyl-CoA hydratase alpha	ROS.....	Reactive oxygen species
		SLC16A2 .....	Solute carrier family 16 member 2

SNPs .....	Single nucleotide polymorphisms
T2 .....	Diiodothyronines
T3 .....	3,3',5-triiodo-L-thyronine
T4 .....	L-thyroxine
TBI .....	Traumatic brain injury
THs .....	Thyroid hormones
TNF $\alpha$ .....	Tumor necrosis factor $\alpha$
TR.....	Thyroid hormone receptor

## Introduction

More than two decades ago, it was already postulated that glial cells may play a significant role in the link between the endocrine and nervous systems [1]. In those days, THs, glucocorticoids, gonadal steroids, and neurosteroids were known to affect myelination by acting on oligodendroglia, modulate astrocyte morphology, differentiation, and gene expression, and activate microglia. Recently, more and more information has been supplied on the beneficial effects of hormone on the brain function. Pathologically, reduced level of hormones in aged brain or cerebrospinal fluid are reported, for example, noradrenaline (NA) [2], insulin [3, 4], THs, growth hormone, estrogen, etc. Among them, insulin, NA and THs regulate metabolic plasticity of astrocytes in aged brain [5]. Therefore, increasing the hormone is one of the ways to improve the aged brain. For example, intranasal insulin administration is speculated as a promising treatment of AD [6, 7], age-related cognitive deficits [8], and traumatic brain injury (TBI) [9]. The mechanism may be due to that insulin reduces nitric oxide (NO), reactive oxygen species (ROS), tumor necrosis factor  $\alpha$  (TNF $\alpha$ ) production, inducible NO synthase (iNOS) expression, while increases phagocytic activity in activated microglia [10].

Not only metabolism-related hormones, social behavior-related hormones also target glial cell. For example, oxytocin seems to target microglia, in addition to neurons, and reduces inflammation in activated microglia [11], and perinatal brain damage [12], or improves neuropsychiatric disorders [13].

Among wide variety of hormones related to brain function, THs are focused and recent advancement in glial research is described.

## Thyroid hormones in the CNS

Among hormones, THs are critical for the regulation of development and differentiation of neurons and glial cells, and hence for development and function of the CNS. In developing CNS, T3 exerts numerous effects regulating astrocyte and

oligodendrocyte differentiation [14-21] and myelination [22]. In addition, THs may control the ratio of oligodendrocytes to astrocytes in white matter [23]. TH is also an important promoter of microglial growth and morphological differentiation [24]. Any impairment of THs supply to the developing CNS causes severe and irreversible changes in the architecture and function of the brain, leading to various neurological dysfunctions as mentioned below. Though the importance of THs during developing brain is obvious, there are few reports on the role of THs in glial cells in adult brain. In the adult brain, THs pathologies, for example hypothyroidism and hyperthyroidism, can cause psychiatric abnormalities such as schizophrenia, bipolar disorder, anxiety and depression. While impact of hypothyroidism and hyperthyroidism on synaptic transmission and plasticity is getting obvious, their effects on glial cells and related cellular mechanisms remain enigmatic.

THs are transported into the brain, metabolized in astrocytes and affect various cell types in the CNS including astrocyte itself. THs have to cross multiple membranes in order to reach their receptors in the nuclei and mitochondria in addition to the ones in the cytoplasm. Especially, THs need to enter the brain through the blood brain barrier (BBB). Astrocytes, forming partly the BBB, are the main cell population incorporating circulating L-thyroxine (T4) through TH transporters. Circulating T4 is transported across the BBB via specific transporters, such as organic anion-transporting polypeptides (OATPs) containing OATP14/SLCO1C1 (OATP1c1) [25-27] and OATP1a2 [28-30], L-type amino acid transporters (LAT1 and LAT2) [31], and monocarboxylate transporters 8 (MCT8) (SLC16A2) (for both T3 and T4) [32] (for review, see [33]). Recently, an important role of radial glia in controlling TH delivery and metabolism is also suggested [34].

Transported T4 into astrocytes is de-iodinated by type 2-deiodinase (D2) to produce T3 [35-37]. Subsequently T3 is released via LAT [38, 39], presumably LAT2, and taken up by other cells via distinct transporters (paracrine signaling). For example, adjacent neurons express MCT8. They also express TH receptors and type 3-deiodinase (D3) which inactivates T3. Since the neuronal paracrine pathway is regulated by hypoxia, ischemia, or inflammation, it is postulated that deiodinases could act as potential control points for the regulation of TH signaling in the brain during health and disease [40].

Since T3 is apparently released from astrocytes in the CNS, it is a typical example of gliendocrine system, a term originally proposed to generally describe interactions between endocrine system and glial cells (Figure 1).

The prevalence of thyroid disorders increases with age [41, 42]. Abnormal levels of THs often causes psychological and behavioral abnormality. Hypothyroidism is one of the most common causes of cognitive impairment [43-46], and can lead to psychiatric symptoms [47]. The complicated problem

is that T4 treatment may not always completely restore normal functioning in patients with hypothyroidism.

Ironically and interestingly, decreased thyroid function may lead to extended longevity [48, 49]. Most likely metabolic/molecular targets of thyroid signaling are linking to the aging process. Therefore, TH signaling and homeostatic maintenance are important in longevity, which are affected by the sympathetic nervous system, growth pathways and insulin signaling, and synchronization to light-dark cycles [50]. Cross talk between TH and longevity is confirmed in experimental data in humans, being modulated by genders. However, the influence and consequence of those cross talk on brain function remains yet elucidated. To live longer demented, or to die younger is the question. The goal would be how to manipulate endocrine system and to live longer without cognitive impairment. Understanding of the problems both in the CNS and periphery will also contribute to finding “rejuvenating” strategies in humans.

Not only hypothyroidism but also hyperthyroidism potentially increase the risk of cognitive impairment or AD [51-53], and cause psychiatric symptoms such as depression. Even subclinical hyperthyroidism (1-15 %) and hypothyroidism (3-16 % in >60 years old) might be a risk factor for the development of dementia [54-57]. Considering the importance of physiological and/or pathophysiological functions of THs in the brain, understanding the neuroglial effects of THs and manipulating their level may help to prevent or ameliorate cognitive impairment or psychological symptoms in the elderly.

### Effects of THs on microglia

Microglia express TH transporters such as OATP4a1, LAT2 and MCT10 [58] and TH receptors such a TR $\alpha$ 1 and TR $\beta$ 1 in cultured rat microglia [24]. T3 is important for microglial development [24], and could directly or indirectly stimulate morphological maturation of amoeboid microglial cells and limit their degeneration [59].

In addition to their genomic effects during development, nongenomic signaling of THs through a plasma membrane-localized receptor has been described [60]. For example, in osteoblast cells, TH signaling is induced through plasma membrane-bound TH receptors and couples to increases in intracellular Ca<sup>2+</sup> concentration, NO, and cyclic guanosine phosphate (cGMP), leading to activation of various kinases such as protein kinase G II, tyrosine kinase Src, extracellular signal-related kinase (ERK), and serine/threonine kinase Akt [61]. Similarly in primary cultured microglial cells, increased migration induced by T3 was observed within 15 min and seems to be due to distinct intracellular signaling

pathways [62] (Figure 1). T3 stimulates microglial migration and phagocytosis *in vitro* and *in vivo* [62, 63] and induces their morphological changes in sex- and age-dependent manner [64], which are summarized in a review [65]. Microglial migration is mediated through T3 uptake by TH transporters and binding to the TRs. Then TH signaling in microglia involved several signaling pathways including Gi/o-protein, phosphoinositide 3-kinase (PI3K), and mitogen-activated protein kinase (MAPK)/ERK, as reported in ATP-induced microglial migration [66] or bradykinin [67] or galanin [68] with slight difference. T3-induced NO signaling [61] is also present in microglia [62]. In addition, Na<sup>+</sup>/K<sup>+</sup>-ATPase, reverse mode of Na<sup>+</sup>/Ca<sup>2+</sup>-exchanger, activation of Ca<sup>2+</sup>-dependent K<sup>+</sup> channel, and GABA receptors likely contribute to T3-induced microglial migration [62], although it is only speculated from pharmacological analyses and the precise mechanism is still unknown. Considering these information, microglial dysfunction in hypothyroidism or hyperthyroidism may be closely related to psychological or cognitive symptoms in elderly patients, which needs be investigated in the future.

### Effects of THs on astrocytes

Effects of THs on astrocytes and regulation of gene expression by THs in cultured astrocytes have been reviewed [27, 69, 70]. However, non-genomic effects of THs in astrocytes still remain to be investigated.

Since astrocytes metabolize T4 to active form (T3) [71], they play a central role in the endocrine control of neural environment [27]. Cultured astrocytes express relevant genes of T3 receptors, TH receptor  $\alpha$ 1 (Thra1) and TH receptor  $\beta$  (TR $\beta$ ), presumably both in the nucleus/mitochondria and in the cytoplasm, and nuclear corepressor (Ncor1) and coactivator (Nco1), in addition to D2 and TH transporter (Mct8/Slc16a2) (autocrine signaling) [70]. During CNS development, T3 exerts various effects in astrocyte differentiation [17, 72], as well as neuronal maturation due to astrocytic production of extracellular matrix proteins and growth factors [71].

Mitochondrial metabolism in astrocytes plays a significant role in neuroprotection. Mitochondrial energy production is rapidly increased via a mitochondrial targeted TH receptors after treatment with T3 [73]. Therefore, targeting astrocyte metabolism to increase brain ATP levels could be an efficient strategy to enhance neuroprotection. Stimulating endogenous ATP release from astrocytes has also been reported to induce antidepressant-like effects in mouse models of depression [74].

Although most energy in the CNS is derived from glucose catabolism, significant energy can also be derived from fatty acid oxidation (FAO) which is stimulated by THs. It has been



shown that hydroxyacyl-CoA dehydrogenase/3-ketoacyl-CoA thiolase/enoyl-CoA hydratase alpha (HADHA), an essential component of the mitochondrial trifunctional protein complex in the FAO cycle, is critical for the FAO regulation by T3 [75]. Since 95% of HADHA co-localize with glial-fibrillary acidic protein (GFAP) in the brain, T3 is considered to upregulate HADHA and subsequent neuroprotective mitochondrial energy production via FAO in astrocytes.

Expression alterations of genes using hypothyroidism model rats show that immature astrocytes immunoreactivity for vimentin and GFAP are increased in the corpus callosum (Shiraki et al., 2014). Analyses of human brain gene expression databases indicate that the chromosome 12p12 locus, where many genomic markers are related to dementia risk, may regulate particular astrocyte-expressed genes induced by T3. Two single nucleotide polymorphisms (SNPs) on chromosome 12p12, rs704180 and rs73069071, were found as risk alleles for non-Alzheimer's neurodegeneration [76, 77] and hippocampal sclerosis pathology [78]. The rs73069071 risk genotype is also associated with altered expression of a nearby astrocyte-expressed gene, SLCO1C1. SLCO1C1 protein transports TH into astrocytes from blood. Interestingly, total T3 levels in cerebrospinal fluid (CSF) are elevated in hippocampal sclerosis cases but not in Alzheimer's disease cases, relative to controls [78]. This suggests that even normal level of T3 in the CSF, astrocyte-TH dysregulation in the brain due to genetic modification contributes to dementia in the elderly. Energy metabolism in hypothyroid brain leads to disruption in astrocyte cytoskeleton as well as glutamatergic and cholinergic neurotransmission, Ca<sup>2+</sup> equilibrium, redox balance, morphological and functional aspects in the cerebral cortex even in young rats from maternal hypothyroidism [79].

### Effects of THs on oligodendrocytes

TH signaling in oligodendrocytes has been also reviewed [80], which suggest both non-genomic and genomic pathways. Requirements of THs in growth and development of oligodendrocyte both *in vitro* and *in vivo* are reported [81-83]. THs also regulate oligodendrocyte accumulation in developing rat brain white matter tracts [20] as well as neural stem cells and oligodendrocyte precursor cells (OPCs) in adult brain [84]. A direct effect of T3 on oligodendrocytes is reported as a stimulant of sulfolipid synthesis, cholesterologenesis and lipogenesis by oligodendrocytes in neurone-free culture system [85]. TH receptors and their isoforms are also reported in oligodendrocytes [86-89]. THs are required for different timing in oligodendrocyte differentiation and development [90, 91], for example at the terminal differentiation [92, 93] or during early stage [94] of OPCs into myelinating oligodendrocytes,

by regulating the probability of cell-cycle withdrawal [95] or depending on the expression of TR $\alpha$ 1 [96]. There are bimodal effects of TR $\alpha$ 1 on cerebellum oligodendrocyte differentiation; At the early postnatal stage, it promotes the secretion of several neurotrophic factors by acting in Purkinje neurons and astrocytes. At later stages, TR $\alpha$ 1 acts in a cell-autonomous manner to ensure the complete arrest of OPC proliferation, explaining contradictory observations made on various models, T3 signaling for synchronizing postnatal neurodevelopment, and restraining OPC proliferation in adult brain [97]. TR $\beta$  seems to be also important; a  $\beta$  receptor selective thyromimetic can enhance oligodendrocyte differentiation *in vitro* and during developmental myelination *in vivo*, suggesting a usefulness as a therapeutic agent for demyelinating models [14].

Important components of TH-regulated timer are cyclin-dependent kinase inhibitor (CKI), p27/Kip1 (p27) or p18/INK (p18) [98]. On the other hand, during TH-induced OPC differentiation, both p53 and p73, but not p63, are involved [99]. During oligodendrocyte differentiation and myelin regeneration, 4 transcription factors are regulated specifically by T3; They are Kruppel-like factor 9 (KLF9), basic helix-loop-helix family member e22 (BHLHe22), Hairless (Hr), and Albumin D box-binding protein (DBP) [100] which is also known as D site of albumin promoter (albumin D-box). Perinatal rodent OPCs cultured with TH under hypoxia become quiescent and acquire adult OPCs-like characteristics, though the mechanism is not clear yet. So far, it is known that the CDK inhibitor, p15/INK4b, plays crucial roles in the TH-dependent cell cycle deceleration in OPCs under hypoxia, while KLF9 is a direct target of TH-dependent signaling [101].

THs affect Schwann cell and oligodendrocyte gene expression [102] and distribution of oligodendrocyte/myelin markers during differentiation [103]. Though glutamine synthetase (GS) is a marker of astrocytes [104], GS as well as myelin/oligodendrocyte glycoprotein (MOG) are involved in maturation of oligodendrocytes [105]. While T3 does not affect on myelin basic protein (MBP) gene expression, T3 stimulates the expression and activity of GS in oligodendrocytes after a lag time through a posttranscriptional event [106]. Therefore THs independently regulate proliferation of OPCs and oligodendrocyte maturation [92, 105]. In addition, it is noteworthy that responsiveness of OPCs to THs is different in different brain area [107].

Using human cultured CD34+ stem cells, differentiation of stem cells into OPCs is stimulated by THs [108]. However, interferon-gamma (IFN- $\gamma$ ) produces a dose-dependent apoptotic response in OPCs [109] or abrogates TH-induced differentiation of OPCs into oligodendrocytes but not into astrocytes. Therefore, as a result, action of IFN- $\gamma$  gives rise to astrocytes [110].



## Therapeutic importance of THs and glial cells

As mentioned above, THs deficiency in developing brain results in low number of microglial cells [24], and immature differentiation of both astrocytes and oligodendrocytes, causing morphological changes in the brain. In hypothyroid model animal, anxiety-like behavior is reported in the male mice [111]. In this model, the spine density on basal dendrites in the CA1 of the hippocampus is not changed but T3-treated hypothyroid mice show lower spine density. This additional effect may be explained by the result of increased microglial phagocytosis [62], though the contribution to the therapeutic outcome is not known. As for the spine density, decrease in spine density by T3 in CA1 region was also reported in adult female rats [112]. Dysfunction of THs impairs myelination. Not only during development but also in the adult brain. For example, THs promote differentiation of oligodendrocyte progenitor cells and improve remyelination after injury [113].

Human mutations of the gene, solute carrier family 16 member 2 (SLC16A2), encoding MCT8, result in the X-linked-inherited psychomotor retardation and hypomyelination disorder, Allan-Herndon-Dudley syndrome (AHDS). It is also reported that mutation of neuronal MCT8 and disrupted T3 uptake by neurons are responsible [114]. Likewise, pharmacological and genetic blockade of MCT8 induces significant oligodendrocyte apoptosis, impairing myelination as a result. Treatment with an MCT8-independent TH analog limits oligodendrocyte apoptosis mediated by SLC16A2 down-regulation, driving myelination. Therefore, MCT8-independent TH analog is implicated as a promising treatment for developmentally-regulated myelination in AHDS [115]. It was also reported that THs alleviate demyelination induced by cuprizone through its role in remyelination [116]. On the contrary, lowering T3

signaling accelerates the reinnervation of the optic tectum following optic nerves crush in adult zebrafish [117].

Since TH is known as a promoter of differentiation of oligodendrocyte, TH is used to validate high-throughput drug screening assay to identify compounds that promote oligodendrocyte differentiation [118].

## Conclusion

THs are important factors both functionally and morphologically for glial cells during development and in adulthood. Therefore, brain dysfunction due to abnormal level of THs could be treated, at least partially, by targeting glial cells.

## Acknowledgments

I thank Prof. Robert Zorec (University of Ljubljana, Slovenia), Dr. Mitsuhiro Morita (Kobe University, Japan), and Dr. Hiroko Kataoka-Ikeshima (Waseda University, Japan) for helpful advice and discussions. This work was supported by Grants-in Aid for Scientific Research of Japan Society for Promotion of Science (JSPS 17K08276) and was partly supported by Research Support Center, Graduate School of Medical Sciences, Kyushu University.

## Conflicts of Interest Statement

The author declares that there is no competing interest.

## References

- Garcia-Segura LM, Chowen JA, Naftolin F. Endocrine glia: roles of glial cells in the brain actions of steroid and thyroid hormones and in the regulation of hormone secretion. *Front Neuroendocrinol.* 1996;17(2):180–211. <https://doi.org/10.1006/frne.1996.0005>
- Marien MR, Colpaert FC, Rosenquist AC. Noradrenergic mechanisms in neurodegenerative diseases: a theory. *Brain Res Brain Res Rev.* 2004;45(1):38–78. <https://doi.org/10.1016/j.brainresrev.2004.02.002>
- Craft S, Claxton A, Baker LD, Hanson AJ, Cholerton B, Trittschuh EH, et al. Effects of Regular and Long-Acting Insulin on Cognition and Alzheimer's Disease Biomarkers: A Pilot Clinical Trial. *J Alzheimers Dis.* 2017;57(4):1325–34. <https://doi.org/10.3233/JAD-161256>
- Gil-Bea FJ, Solas M, Solomon A, Mugueta C, Winblad B, Kivipelto M, et al. Insulin levels are decreased in the cerebrospinal fluid of women with prodromal Alzheimer's disease. *J Alzheimers Dis.* 2010;22(2):405–13. <https://doi.org/10.3233/JAD-2010-100795>
- Morita M, Ikeshima-Kataoka H, Kreft M, Vardjan N, Zorec R, Noda M. Metabolic Plasticity of Astrocytes and Aging of the Brain. *Int J Mol Sci.* 2019;20(4). <https://doi.org/10.3390/ijms20040941>
- Claxton A, Baker LD, Hanson A, Trittschuh EH, Cholerton B, Morgan A, et al. Long Acting Intranasal Insulin Detemir Im-

- proves Cognition for Adults with Mild Cognitive Impairment or Early-Stage Alzheimer's Disease Dementia. *J Alzheimers Dis.* 2015;45(4):1269–70. <https://doi.org/10.3233/JAD-159002>
7. Claxton A, Baker LD, Hanson A, Trittschuh EH, Cholerton B, Morgan A, et al. Long-acting intranasal insulin detemir improves cognition for adults with mild cognitive impairment or early-stage Alzheimer's disease dementia. *J Alzheimers Dis.* 2015;44(3):897–906. <https://doi.org/10.3233/JAD-141791>
  8. Maimaiti S, Anderson KL, DeMoll C, Brewer LD, Rauh BA, Gant JC, et al. Intranasal Insulin Improves Age-Related Cognitive Deficits and Reverses Electrophysiological Correlates of Brain Aging. *J Gerontol A Biol Sci Med Sci.* 2016;71(1):30–9. <https://doi.org/10.1093/gerona/glu314>
  9. Brabazon F, Wilson CM, Jaiswal S, Reed J, Frey WHN, Byrnes KR. Intranasal insulin treatment of an experimental model of moderate traumatic brain injury. *J Cereb Blood Flow Metab.* 2017;37(9):3203–18. <https://doi.org/10.1177/0271678X16685106>
  10. Brabazon F, Bermudez S, Shaughnessy M, Khayrullina G, Byrnes KR. The effects of insulin on the inflammatory activity of BV2 microglia. *PLoS one.* 2018;13(8):e0201878. <https://doi.org/10.1371/journal.pone.0201878>
  11. Yuan L, Liu S, Bai X, Gao Y, Liu G, Wang X, et al. Oxytocin inhibits lipopolysaccharide-induced inflammation in microglial cells and attenuates microglial activation in lipopolysaccharide-treated mice. *J Neuroinflammation.* 2016;13(1):77. <https://doi.org/10.1186/s12974-016-0541-7>
  12. Mairesse J, Zinni M, Pansiot J, Hassan-Abdi R, Demene C, Colella M, et al. Oxytocin receptor agonist reduces perinatal brain damage by targeting microglia. *Glia.* 2019;67(2):345–59. <https://doi.org/10.1002/glia.23546>
  13. Kato TA, Hayakawa K, Monji A, Kanba S. Missing and Possible Link between Neuroendocrine Factors, Neuropsychiatric Disorders, and Microglia. *Front Integr Neurosci.* 2013;7:53. <https://doi.org/10.3389/fnint.2013.00053>
  14. Baxi EG, Schott JT, Fairchild AN, Kirby LA, Karani R, Uapinyoying P, et al. A selective thyroid hormone beta receptor agonist enhances human and rodent oligodendrocyte differentiation. *Glia.* 2014;62(9):1513–29. <https://doi.org/10.1002/glia.22697>
  15. Dezonne RS, Stipursky J, Gomes FC. Effect of thyroid hormone depletion on cultured murine cerebral cortex astrocytes. *Neurosci Lett.* 2009;467(2):58–62. <https://doi.org/10.1016/j.neulet.2009.10.001>
  16. Jones SA, Jolson DM, Cuta KK, Mariash CN, Anderson GW. Triiodothyronine is a survival factor for developing oligodendrocytes. *Mol Cell Endocrinol.* 2003;199(1-2):49–60.
  17. Manzano J, Bernal J, Morte B. Influence of thyroid hormones on maturation of rat cerebellar astrocytes. *Int J Dev Neurosci.* 2007;25(3):171–9. <https://doi.org/10.1016/j.ijdevneu.2007.01.003>
  18. Martinez-Galan JR, Escobar del Rey F, Morreale de Escobar G, Santacana M, Ruiz-Marcos A. Hypothyroidism alters the development of radial glial cells in the term fetal and postnatal neocortex of the rat. *Brain Res Dev Brain Res.* 2004;153(1):109–14. <https://doi.org/10.1016/j.devbrainres.2004.08.002>
  19. Martinez-Galan JR, Pedraza P, Santacana M, Escobar del Rey F, Morreale de Escobar G, Ruiz-Marcos A. Myelin basic protein immunoreactivity in the internal capsule of neonates from rats on a low iodine intake or on methylmercaptoimidazole (MMI). *Brain Res Dev Brain Res.* 1997;101(1–2):249–56.
  20. Schoonover CM, Seibel MM, Jolson DM, Stack MJ, Rahman RJ, Jones SA, et al. Thyroid hormone regulates oligodendrocyte accumulation in developing rat brain white matter tracts. *Endocrinology.* 2004;145(11):5013–20. <https://doi.org/10.1210/en.2004-0065>
  21. Stenzel D, Huttner WB. Role of maternal thyroid hormones in the developing neocortex and during human evolution. *Front Neuroanat.* 2013;7:19. <https://doi.org/10.3389/fnana.2013.00019>
  22. Ferreira AA, Pereira MJ, Manhaes AC, Barradas PC. Ultrastructural identification of oligodendrocyte/myelin proteins in corpus callosum of hypothyroid animals. *Int J Dev Neurosci.* 2007;25(2):87–94. <https://doi.org/10.1016/j.ijdevneu.2006.12.007>
  23. Sharlin DS, Tighe D, Gilbert ME, Zoeller RT. The balance between oligodendrocyte and astrocyte production in major white matter tracts is linearly related to serum total thyroxine. *Endocrinology.* 2008;149(5):2527–36. <https://doi.org/10.1210/en.2007-1431>
  24. Lima FR, Gervais A, Colin C, Izembart M, Neto VM, Mallat M. Regulation of microglial development: a novel role for thyroid hormone. *J Neurosci.* 2001;21(6):2028–38.
  25. Sugiyama D, Kusuhara H, Taniguchi H, Ishikawa S, Nozaki Y, Aburatani H, et al. Functional characterization of rat brain-specific organic anion transporter (Oatp14) at the blood-brain barrier: high affinity transporter for thyroxine. *JBC.* 2003;278(44):43489–95. <https://doi.org/10.1074/jbc.M306933200>
  26. Tohyama K, Kusuhara H, Sugiyama Y. Involvement of multispecific organic anion transporter, Oatp14 (Slc21a14), in the transport of thyroxine across the blood-brain barrier. *Endocrinology.* 2004;145(9):4384–91. <https://doi.org/10.1210/en.2004-0058>
  27. Dezonne RS, Lima FR, Trentin AG, Gomes FC. Thyroid hormone and astroglia: endocrine control of the neural environment. *J Neuroendocrinol.* 2015;27(6):435–45. <https://doi.org/10.1111/jne.12283>
  28. Huber RD, Gao B, Sidler Pfandler MA, Zhang-Fu W, Leuthold S, Hagenbuch B, Folkers G, Meier PJ, Stieger B. Characterization of two splice variants of human organic anion transporting polypeptide 3A1 isolated from human brain. *Am J Physiol Cell Physiol.* 2007;292(2):C795-806. <https://doi.org/10.1152/ajpcell.00597.2005>
  29. Hagenbuch B. Cellular entry of thyroid hormones by organic anion transporting polypeptides. *Best Pract Res Clin Endo-*

- crinol Metab. 2007;21(2):209–21. <https://doi.org/10.1016/j.beem.2007.03.004>
30. Lee W, Glaeser H, Smith LH, Roberts RL, Moeckel GW, Gervasini G, et al. Polymorphisms in human organic anion-transporting polypeptide 1A2 (OATP1A2): implications for altered drug disposition and central nervous system drug entry. *JBC*. 2005;280(10):9610–7. <https://doi.org/10.1074/jbc.M411092200>
  31. Taylor PM, Ritchie JW. Tissue uptake of thyroid hormone by amino acid transporters. *Best Pract Res Clin Endocrinol Metab*. 2007;21(2):237–51. <https://doi.org/10.1016/j.beem.2007.03.002>
  32. Roberts LM, Woodford K, Zhou M, Black DS, Haggerty JE, Tate EH, et al. Expression of the thyroid hormone transporters monocarboxylate transporter-8 (SLC16A2) and organic ion transporter-14 (SLCO1C1) at the blood-brain barrier. *Endocrinology*. 2008;149(12):6251–61. <https://doi.org/10.1210/en.2008-0378>
  33. Bernal J, Guadano-Ferraz A, Morte B. Thyroid hormone transporters--functions and clinical implications. *Nat Rev Endocrinol*. 2015;11(7):406–17. <https://doi.org/10.1038/nrendo.2015.66>
  34. Lopez-Espindola D, Garcia-Aldea A, Gomez de la Riva I, Rodriguez-Garcia AM, Salvatore D, Visser TJ, et al. Thyroid hormone availability in the human fetal brain: novel entry pathways and role of radial glia. *Brain Struct Funct*. 2019;224(6):2103–19. <https://doi.org/10.1007/s00429-019-01896-8>
  35. Di Liegro I. Thyroid hormones and the central nervous system of mammals (Review). *Mol Med Rep*. 2008;1(3):279–95.
  36. Fliers E, Alkemade A, Wiersinga WM, Swaab DF. Hypothalamic thyroid hormone feedback in health and disease. *Prog Brain Res*. 2006;153:189–207. [https://doi.org/10.1016/S0079-6123\(06\)53011-0](https://doi.org/10.1016/S0079-6123(06)53011-0)
  37. Guadano-Ferraz A, Obregon MJ, St Germain DL, Bernal J. The type 2 iodothyronine deiodinase is expressed primarily in glial cells in the neonatal rat brain. *Proceedings of the National Academy of Sciences of the United States of America*. 1997;94(19):10391–6.
  38. Blondeau JP, Beslin A, Chantoux F, Francon J. Triiodothyronine is a high-affinity inhibitor of amino acid transport system L1 in cultured astrocytes. *J Neurochem*. 1993;60(4):1407–13.
  39. Francon J, Chantoux F, Blondeau JP. Carrier-mediated transport of thyroid hormones into rat glial cells in primary culture. *J Neurochem*. 1989;53(5):1456–63.
  40. Freitas BC, Gereben B, Castillo M, Kallo I, Zeold A, Egri P, et al. Paracrine signaling by glial cell-derived triiodothyronine activates neuronal gene expression in the rodent brain and human cells. *J Clin Invest*. 2010;120(6):2206–17. <https://doi.org/10.1172/JCI41977>
  41. Begin ME, Langlois MF, Lorrain D, Cunnane SC. Thyroid Function and Cognition during Aging. *Curr Gerontol Geriatr Res*. 2008:474868. <https://doi.org/10.1155/2008/474868>
  42. Gesing A, Lewinski A, Karbownik-Lewinska M. The thyroid gland and the process of aging; what is new? *Thyroid Res*. 2012;5(1):16. <https://doi.org/10.1186/1756-6614-5-16>
  43. Chen Z, Liang X, Zhang C, Wang J, Chen G, Zhang H, et al. Correlation of thyroid dysfunction and cognitive impairments induced by subcortical ischemic vascular disease. *Brain Behav*. 2016;6(4):e00452. <https://doi.org/10.1002/brb3.452>
  44. Dugbartey AT. Neurocognitive aspects of hypothyroidism. *Arch Intern Med*. 1998;158(13):1413–8.
  45. Mallett P, Andrew M, Hunter C, Smith J, Richards C, Othman S, et al. Cognitive function, thyroid status and postpartum depression. *Acta Psychiatr Scand*. 1995;91(4):243–6.
  46. Tan ZS, Beiser A, Vasan RS, Au R, Auerbach S, Kiel DP, et al. Thyroid function and the risk of Alzheimer disease: the Framingham Study. *Arch Intern Med*. 2008;168(14):1514–20. <https://doi.org/10.1001/archinte.168.14.1514>
  47. Mavrosan MM, Patel N, Akker E. Myxedema Psychosis in a Patient With Undiagnosed Hashimoto Thyroiditis. *J Am Osteopath Assoc*. 2017;117(1):50–4. <https://doi.org/10.7556/jaoa.2017.007>
  48. Gesing A. The thyroid gland and the process of aging. *Thyroid Res*. 2015;8((Suppl 1)):A8.
  49. Buffenstein R, Pinto M. Endocrine function in naturally long-living small mammals. *Mol Cell Endocrinol*. 2009;299(1):101–11. <https://doi.org/10.1016/j.mce.2008.04.021>
  50. Bowers J, Terrien J, Clerget-Froidevaux MS, Gothie JD, Rozing MP, Westendorp RG, et al. Thyroid hormone signaling and homeostasis during aging. *Endocr Rev*. 2013;34(4):556–89. Epub 2013/05/23. <https://doi.org/10.1210/er.2012-1056>
  51. Kalmijn S, Mehta KM, Pols HA, Hofman A, Drexhage HA, Breteler MM. Subclinical hyperthyroidism and the risk of dementia. The Rotterdam study. *Clin Endocrinol (Oxf)*. 2000;53(6):733–7.
  52. van Osch LA, Hogervorst E, Combrinck M, Smith AD. Low thyroid-stimulating hormone as an independent risk factor for Alzheimer disease. *Neurology*. 2004;62(11):1967–71.
  53. Wijsman LW, de Craen AJ, Trompet S, Gussekloo J, Stott DJ, Rodondi N, et al. Subclinical thyroid dysfunction and cognitive decline in old age. *PloS one*. 2013;8(3):e59199. <https://doi.org/10.1371/journal.pone.0059199>
  54. Ganguli M, Burmeister LA, Seaberg EC, Belle S, DeKosky ST. Association between dementia and elevated TSH: a community-based study. *Biol Psychiatry*. 1996;40(8):714–25. [https://doi.org/10.1016/0006-3223\(95\)00489-0](https://doi.org/10.1016/0006-3223(95)00489-0)
  55. Tan ZS, Vasan RS. Thyroid function and Alzheimer's disease. *J Alzheimers Dis*. 2009;16(3):503–7. <https://doi.org/10.3233/JAD-2009-0991>
  56. Johansson P, Almqvist EG, Johansson JO, Mattsson N, Hansson O, Wallin A, et al. Reduced cerebrospinal fluid level of thyroxine in patients with Alzheimer's disease. *Psychoneuroendocrinology*. 2013;38(7):1058–66. <https://doi.org/10.1016/j.psyneuen.2012.10.012>

57. Biondi B, Cooper DS. The clinical significance of subclinical thyroid dysfunction. *Endocr Rev.* 2008;29(1):76–131. <https://doi.org/10.1210/er.2006-0043>
58. Braun D, Kinne A, Brauer AU, Sapin R, Klein MO, Kohrle J, et al. Developmental and cell type-specific expression of thyroid hormone transporters in the mouse brain and in primary brain cells. *Glia.* 2011;59(3):463–71. <https://doi.org/10.1002/glia.21116>
59. Mallat M, Lima FR, Gervais A, Colin C, Moura Neto V. New insights into the role of thyroid hormone in the CNS: the microglial track. *Mol Psychiatry.* 2002;7(1):7–8. <https://doi.org/10.1038/sj.mp.4001988>
60. Davis PJ, Goglia F, Leonard JL. Nongenomic actions of thyroid hormone. *Nat Rev Endocrinol.* 2016;12(2):111–21. <https://doi.org/10.1038/nrendo.2015.205>
61. Kalyanaraman H, Schwappacher R, Joshua J, Zhuang S, Scott BT, Klos M, et al. Nongenomic thyroid hormone signaling occurs through a plasma membrane-localized receptor. *Sci Signal.* 2014;7(326):ra48. <https://doi.org/10.1126/scisignal.2004911>
62. Mori Y, Tomonaga D, Kalashnikova A, Furuya F, Akimoto N, Ifuku M, et al. Effects of 3,3',5-triiodothyronine on microglial functions. *Glia.* 2015;63(5):906–20. <https://doi.org/10.1002/glia.22792>
63. Noda M. Possible role of glial cells in the relationship between thyroid dysfunction and mental disorders. *Front Cell Neurosci.* 2015;9:194. <https://doi.org/10.3389/fncel.2015.00194>
64. Noda M, Mori Y, Yoshioka Y. Sex- and Age-Dependent Effects of Thyroid Hormone on Glial Morphology and Function. *OM&P.* 2016;2:85–92.
65. Noda M. Thyroid Hormone in the CNS: Contribution of Neuron-Glia Interaction. *Vitam Horm.* 2018;106:313–31. <https://doi.org/10.1016/bs.vh.2017.05.005>
66. Honda S, Sasaki Y, Ohsawa K, Imai Y, Nakamura Y, Inoue K, et al. Extracellular ATP or ADP induce chemotaxis of cultured microglia through *Gi/o*-coupled P2Y receptors. *J Neurosci.* 2001;21(6):1975–82.
67. Ifuku M, Farber K, Okuno Y, Yamakawa Y, Miyamoto T, Nolte C, et al. Bradykinin-induced microglial migration mediated by B1-bradykinin receptors depends on  $Ca^{2+}$  influx via reverse-mode activity of the  $Na^{+}/Ca^{2+}$  exchanger. *J Neurosci.* 2007;27(48):13065–73. <https://doi.org/10.1523/JNEUROSCI.3467-07.2007>
68. Ifuku M, Okuno Y, Yamakawa Y, Izumi K, Seifert S, Kettenmann H, et al. Functional importance of inositol-1,4,5-triphosphate-induced intracellular  $Ca^{2+}$  mobilization in galanin-induced microglial migration. *J Neurochem.* 2011;117(1):61–70. <https://doi.org/10.1111/j.1471-4159.2011.07176.x>
69. Morte B, Bernal J. Thyroid hormone action: astrocyte-neuron communication. *Front Endocrinol (Lausanne).* 2014;5:82. <https://doi.org/10.3389/fendo.2014.00082>
70. Morte B, Gil-Ibanez P, Bernal J. Regulation of Gene Expression by Thyroid Hormone in Primary Astrocytes: Factors Influencing the Genomic Response. *Endocrinology.* 2018;159(5):2083–92. <https://doi.org/10.1210/en.2017-03084>
71. Trentin AG. Thyroid hormone and astrocyte morphogenesis. *J Endocrinol.* 2006;189(2):189–97. <https://doi.org/10.1677/joe.1.06680>
72. Das M, Ghosh M, Gharami K, Das S. Thyroid Hormone and Astrocyte Differentiation. *Vitam Horm.* 2018;106:283–312. <https://doi.org/10.1016/bs.vh.2017.05.004>
73. Saelim N, John LM, Wu J, Park JS, Bai Y, Camacho P, et al. Nontranscriptional modulation of intracellular  $Ca^{2+}$  signaling by ligand stimulated thyroid hormone receptor. *J Cell Biol.* 2004;167(5):915–24. <https://doi.org/10.1083/jcb.200409011>
74. Cao X, Li LP, Wang Q, Wu Q, Hu HH, Zhang M, et al. Astrocyte-derived ATP modulates depressive-like behaviors. *Nat Med.* 2013;19(6):773–7. <https://doi.org/10.1038/nm.3162>
75. Chocron ES, Sayre NL, Holstein D, Saelim N, Ibdah JA, Dong LQ, et al. The trifunctional protein mediates thyroid hormone receptor-dependent stimulation of mitochondria metabolism. *Mol Endocrinol.* 2012;26(7):1117–28. <https://doi.org/10.1210/me.2011-1348>
76. Roostaei T, Nazeri A, Felsky D, De Jager PL, Schneider JA, Pollock BG, et al. Genome-wide interaction study of brain beta-amyloid burden and cognitive impairment in Alzheimer's disease. *Mol Psychiatry.* 2017;22(2):287–95. <https://doi.org/10.1038/mp.2016.35>
77. Nelson PT, Estus S, Abner EL, Parikh I, Malik M, Neltner JH, et al. ABCC9 gene polymorphism is associated with hippocampal sclerosis of aging pathology. *Acta Neuropathol.* 2014;127(6):825–43. <https://doi.org/10.1007/s00401-014-1282-2>
78. Nelson PT, Katsumata Y, Nho K, Artiushin SC, Jicha GA, Wang WX, et al. Genomics and CSF analyses implicate thyroid hormone in hippocampal sclerosis of aging. *Acta Neuropathol.* 2016;132(6):841–58. <https://doi.org/10.1007/s00401-016-1641-2>
79. Domingues JT, Wajima CS, Cesconetto PA, Parisotto EB, Winkelmann-Duarte E, Santos KD, et al. Experimentally-induced maternal hypothyroidism alters enzyme activities and the sensorimotor cortex of the offspring rats. *Mol Cell Endocrinol.* 2018;478:62–76. <https://doi.org/10.1016/j.mce.2018.07.008>
80. Lee JY, Petratos S. Thyroid Hormone Signaling in Oligodendrocytes: from Extracellular Transport to Intracellular Signal. *Mol Neurobiol.* 2016;53(9):6568–83. <https://doi.org/10.1007/s12035-016-0013-1>
81. Bottenstein JE. Growth requirements in vitro of oligodendrocyte cell lines and neonatal rat brain oligodendrocytes. *Proceedings of the National Academy of Sciences of the United States of America.* 1986;83(6):1955–9.
82. Barres BA, Lazar MA, Raff MC. A novel role for thyroid hormone, glucocorticoids and retinoic acid in timing oligodendrocyte development. *Development.* 1994;120(5):1097–108.
83. Rodriguez-Pena A. Oligodendrocyte development and thyroid hormone. *Journal of neurobiology.* 1999;40(4):497–512.

84. Fernandez M, Pirondi S, Manservigi M, Giardino L, Calza L. Thyroid hormone participates in the regulation of neural stem cells and oligodendrocyte precursor cells in the central nervous system of adult rat. *Eur J Neurosci.* 2004;20(8):2059–70. <https://doi.org/10.1111/j.1460-9568.2004.03664.x>
85. Koper JW, Hoeben RC, Hochstenbach FM, van Golde LM, Lopes-Cardozo M. Effects of triiodothyronine on the synthesis of sulfolipids by oligodendrocyte-enriched glial cultures. *Biochim Biophys Acta.* 1986;887(3):327–34.
86. Baas D, Fressinaud C, Ittel ME, Reeber A, Dalencon D, Puymirat J, et al. Expression of thyroid hormone receptor isoforms in rat oligodendrocyte cultures. Effect of 3,5,3'-triiodo-L-thyronine. *Neurosci Lett.* 1994;176(1):47–51.
87. Baas D, Bourbeau D, Carre JL, Sarlieve LL, Dussault JH, Puymirat J. Expression of alpha and beta thyroid receptors during oligodendrocyte differentiation. *Neuroreport.* 1994;5(14):1805–8.
88. Carre JL, Demerens C, Rodriguez-Pena A, Floch HH, Vincendon G, Sarlieve LL. Thyroid hormone receptor isoforms are sequentially expressed in oligodendrocyte lineage cells during rat cerebral development. *J Neurosci Res.* 1998;54(5):584–94. [https://doi.org/10.1002/\(SICI\)1097-4547\(19981201\)54:5<584::AID-JNR3>3.0.CO;2-X](https://doi.org/10.1002/(SICI)1097-4547(19981201)54:5<584::AID-JNR3>3.0.CO;2-X)
89. Sarlieve LL, Rodriguez-Pena A, Langley K. Expression of thyroid hormone receptor isoforms in the oligodendrocyte lineage. *Neurochem Res.* 2004;29(5):903–22.
90. Billon N, Tokumoto Y, Forrest D, Raff M. Role of thyroid hormone receptors in timing oligodendrocyte differentiation. *Dev Biol.* 2001;235(1):110–20. <https://doi.org/10.1006/dbio.2001.0293>
91. Kondo T. [Cell-intrinsic timer regulating oligodendrocyte development]. *Tanpakushitsu Kakusan Koso.* 2001;46(7):821–8.
92. Ahlgren SC, Wallace H, Bishop J, Neophytou C, Raff MC. Effects of thyroid hormone on embryonic oligodendrocyte precursor cell development in vivo and in vitro. *Mol Cell Neurosci.* 1997;9(5-6):420–32. <https://doi.org/10.1006/mcne.1997.0631>
93. Baas D, Legrand C, Samarut J, Flamant F. Persistence of oligodendrocyte precursor cells and altered myelination in optic nerve associated to retina degeneration in mice devoid of all thyroid hormone receptors. *Proceedings of the National Academy of Sciences of the United States of America.* 2002;99(5):2907–11. <https://doi.org/10.1073/pnas.052482299>
94. Tokumoto YM, Durand B, Raff MC. An analysis of the early events when oligodendrocyte precursor cells are triggered to differentiate by thyroid hormone, retinoic acid, or PDGF withdrawal. *Dev Biol.* 1999;213(2):327–39. <https://doi.org/10.1006/dbio.1999.9397>
95. Gao FB, Apperly J, Raff M. Cell-intrinsic timers and thyroid hormone regulate the probability of cell-cycle withdrawal and differentiation of oligodendrocyte precursor cells. *Dev Biol.* 1998;197(1):54–66. <https://doi.org/10.1006/dbio.1998.8877>
96. Billon N, Jolicoeur C, Tokumoto Y, Vennstrom B, Raff M. Normal timing of oligodendrocyte development depends on thyroid hormone receptor alpha 1 (TRalpha1). *EMBO J.* 2002;21(23):6452–60.
97. Picou F, Fauquier T, Chatonnet F, Flamant F. A bimodal influence of thyroid hormone on cerebellum oligodendrocyte differentiation. *Mol Endocrinol.* 2012;26(4):608–18. <https://doi.org/10.1210/me.2011-1316>
98. Tokumoto YM, Apperly JA, Gao FB, Raff MC. Posttranscriptional regulation of p18 and p27 Cdk inhibitor proteins and the timing of oligodendrocyte differentiation. *Dev Biol.* 2002;245(1):224–34. <https://doi.org/10.1006/dbio.2002.0626>
99. Billon N, Terroni A, Jolicoeur C, McCarthy A, Richardson WD, Melino G, et al. Roles for p53 and p73 during oligodendrocyte development. *Development.* 2004;131(6):1211–20. <https://doi.org/10.1242/dev.01035>
100. Dugas JC, Ibrahim A, Barres BA. The T3-induced gene KLF9 regulates oligodendrocyte differentiation and myelin regeneration. *Mol Cell Neurosci.* 2012;50(1):45–57. <https://doi.org/10.1016/j.mcn.2012.03.007>
101. Tokumoto Y, Tamaki S, Kabe Y, Takubo K, Suematsu M. Quiescence of adult oligodendrocyte precursor cells requires thyroid hormone and hypoxia to activate Runx1. *Sci Rep.* 2017;7(1):1019. <https://doi.org/10.1038/s41598-017-01023-9>
102. Knipper M, Bandtlow C, Gestwa L, Kopschall I, Rohbock K, Wiechers B, et al. Thyroid hormone affects Schwann cell and oligodendrocyte gene expression at the glial transition zone of the VIIIth nerve prior to cochlea function. *Development.* 1998;125(18):3709–18.
103. Younes-Rapozo V, Berendonk J, Savignon T, Manhaes AC, Barradas PC. Thyroid hormone deficiency changes the distribution of oligodendrocyte/myelin markers during oligodendroglial differentiation in vitro. *Int J Dev Neurosci.* 2006;24(7):445–53. <https://doi.org/10.1016/j.ijdevneu.2006.08.004>
104. Anlauf E, Derouiche A. Glutamine synthetase as an astrocytic marker: its cell type and vesicle localization. *Front Endocrinol (Lausanne).* 2013;4:144. <https://doi.org/10.3389/fendo.2013.00144>
105. Baas D, Bourbeau D, Sarlieve LL, Ittel ME, Dussault JH, Puymirat J. Oligodendrocyte maturation and progenitor cell proliferation are independently regulated by thyroid hormone. *Glia.* 1997;19(4):324–32.
106. Baas D, Fressinaud C, Vitkovic L, Sarlieve LL. Glutamine synthetase expression and activity are regulated by 3,5,3'-triiodo-L-thyronine and hydrocortisone in rat oligodendrocyte cultures. *Int J Dev Neurosci.* 1998;16(5):333–40.
107. Power J, Mayer-Proschel M, Smith J, Noble M. Oligodendrocyte precursor cells from different brain regions express divergent properties consistent with the differing time courses of myelination in these regions. *Dev Biol.* 2002;245(2):362–75. <https://doi.org/10.1006/dbio.2002.0610>

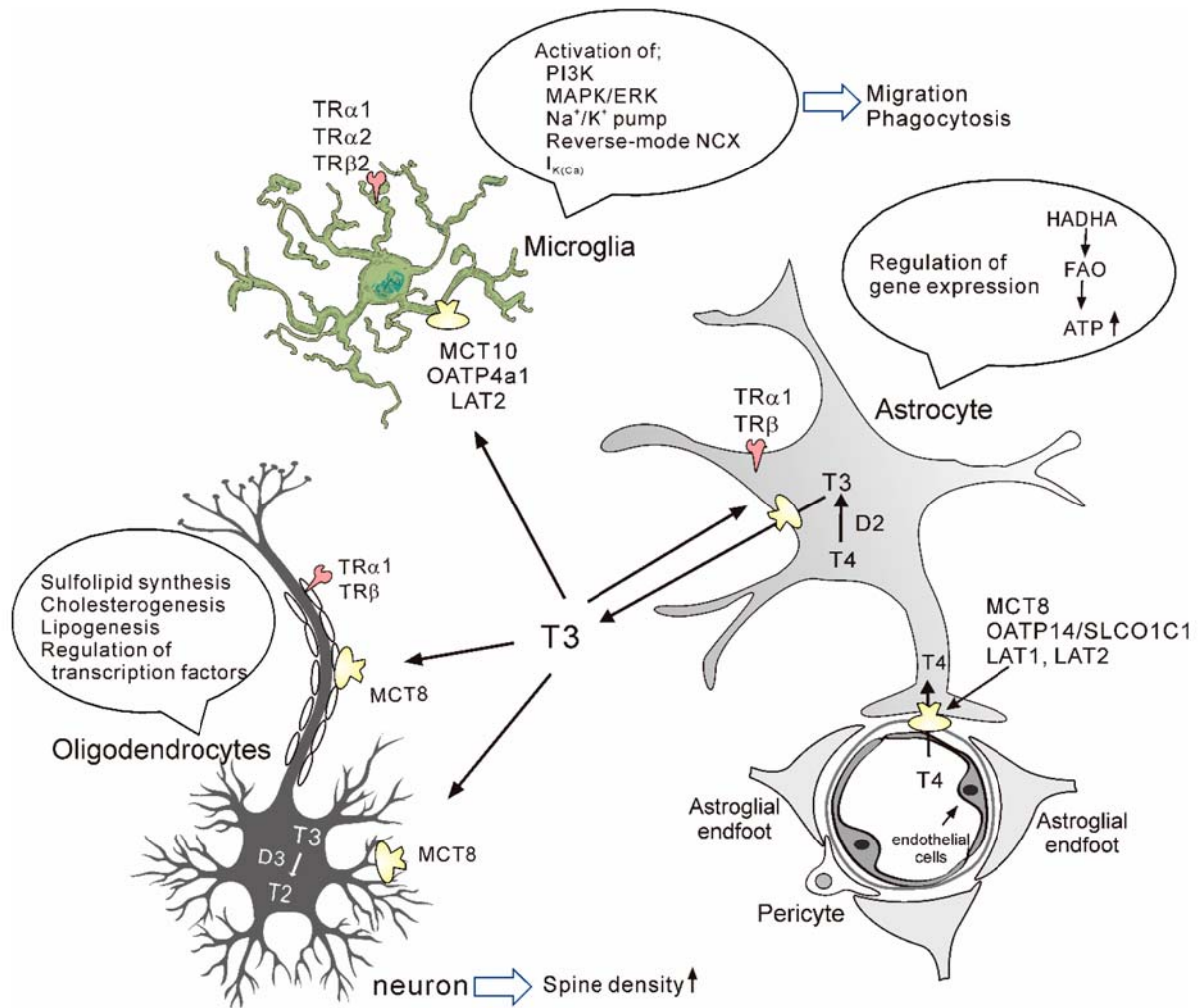


108. Venkatesh K, Srikanth L, Vengamma B, Chandrasekhar C, Prasad BC, Sarma PV. In vitro transdifferentiation of human cultured CD34+ stem cells into oligodendrocyte precursors using thyroid hormones. *Neurosci Lett*. 2015;588:36–41. <https://doi.org/10.1016/j.neulet.2014.12.050>
109. Chew LJ, King WC, Kennedy A, Gallo V. Interferon-gamma inhibits cell cycle exit in differentiating oligodendrocyte progenitor cells. *Glia*. 2005;52(2):127–43. <https://doi.org/10.1002/glia.20232>
110. Tanner DC, Cherry JD, Mayer-Proschel M. Oligodendrocyte progenitors reversibly exit the cell cycle and give rise to astrocytes in response to interferon-gamma. *J Neurosci*. 2011;31(16):6235–46. <https://doi.org/10.1523/JNEUROSCI.5905-10.2011>
111. Buras A, Battle L, Landers E, Nguyen T, Vasudevan N. Thyroid hormones regulate anxiety in the male mouse. *Horm Behav*. 2014;65(2):88–96. <https://doi.org/10.1016/j.yhbeh.2013.11.008>
112. Gould E, Allan MD, McEwen BS. Dendritic spine density of adult hippocampal pyramidal cells is sensitive to thyroid hormone. *Brain Res*. 1990;20;525(2):327–9.
113. Franco PG, Silvestroff L, Soto EF, Pasquini JM. Thyroid hormones promote differentiation of oligodendrocyte progenitor cells and improve remyelination after cuprizone-induced demyelination. *Exp Neurol*. 2008;212(2):458–67. <https://doi.org/10.1016/j.expneurol.2008.04.039>
114. Wirth EK, Roth S, Blechschmidt C, Holter SM, Becker L, Racz I, et al. Neuronal 3',3,5-triiodothyronine (T3) uptake and behavioral phenotype of mice deficient in Mct8, the neuronal T3 transporter mutated in Allan-Herndon-Dudley syndrome. *J Neurosci*. 2009;29(30):9439–49. <https://doi.org/10.1523/JNEUROSCI.6055-08.2009>
115. Lee JY, Kim MJ, Deliyanti D, Azari MF, Rossello F, Costin A, et al. Overcoming Monocarboxylate Transporter 8 (MCT8)-Deficiency to Promote Human Oligodendrocyte Differentiation and Myelination. *EBioMedicine*. 2017;25:122–35. <https://doi.org/10.1016/j.ebiom.2017.10.016>
116. Zhang M, Zhan XL, Ma ZY, Chen XS, Cai QY, Yao ZX. Thyroid hormone alleviates demyelination induced by cuprizone through its role in remyelination during the remission period. *Exp Biol Med (Maywood)*. 2015;240(9):1183–96. <https://doi.org/10.1177/1535370214565975>
117. Bhumika S, Lemmens K, Vancamp P, Moons L, Darras VM. Decreased thyroid hormone signaling accelerates the reinnervation of the optic tectum following optic nerve crush in adult zebrafish. *Mol Cell Neurosci*. 2015;68:92–102. <https://doi.org/10.1016/j.mcn.2015.04.002>
118. Lariosa-Willingham K, Leonoudakis D. Using Acutely Dissociated and Purified Oligodendrocyte Precursor Cells for High-Throughput Drug Screening to Identify Compounds that Promote Oligodendrocyte Differentiation. *Curr Protoc Cell Biol*. 2018;79(1):e49. <https://doi.org/10.1002/cpcb.49>



Figures

**Figure 1.** Gliendocrine system and functions of THs in the CNS. Circulating T4 is transported across the blood-brain barrier via specific transporters and enters into astrocytes, where it is type 2-deiodinase (D2) to produce T3. Subsequently T3 is released by transporters, and taken by other cells such as microglia, oligodendrocytes, and neurons via distinct transporters. T3 also affects astrocytes as autocrine signal.



# IMPROVING PERFORMANCE TOGETHER: TWINNING PARTNERSHIP BETWEEN MEDIUM AND LOW PERFORMER DISTRICTS IN ETHIOPIA

Mesele Damte Argaw<sup>1,2</sup>, Binyam Fekadu Desta<sup>1,2</sup>, Melkamu Getu Abebe<sup>1</sup>, Elias Mamo<sup>1</sup>, Tesfaye Gebru<sup>1</sup>, Wubishet Kebede Heyi<sup>1</sup>, Chala Gela<sup>1</sup>, Temesgen Ayehu Bele<sup>3</sup>

<sup>1</sup>USAID Transform: Primary Health Care, JSI Research & Training Institutes, Inc. in Ethiopia

<sup>2</sup>University of South Africa (UNISA), Pretoria, South Africa

<sup>3</sup>Federal Ministry of Health (FMOH), Health Extension Program and Primary Health Care Services Directorate, Ethiopia

## Abstract

This article describes the United States Agency for International Development Transform: Primary Health Care Activity supported a twinning partnership strategy, which was implemented between districts (woredas) in the different performance categories. This study presents the details of the partnership and the result observed in health systems strengthening in Ethiopia. The twinning partnership strategy was implemented with six steps. The established relationship helps the health systems to build the skill and capacities of the health workforce at primary healthcare entities. Both partner woredas improved their performances through the established win-win relationship and institutionalized the characteristics of a learning organization.

## Keywords

*Twinning Partnership • Performance Improvement • Learning Organization • Ethiopia*

## Introduction

In the past two decades, Ethiopia successfully implemented Health Sector Development Programs (HSDP I to IV) and invested heavily its resources in health systems strengthening interventions [1]. As a result, Ethiopia has done remarkably well in meeting most of the Millennium Development Goal (MDG) targets. Among the notable achievements of MDG-4 with a 67 percent drop in under-five mortality from the 1990 estimate that contributed to an increase in average life expectancy at birth from 45 in 1990 to 64 in 2014. And a 69 percent decrease in maternal mortality ratio from a high estimated base of 1400 per 100,000 live births. In addition, an improvement in contraceptive prevalence rate from 3% to 42% has led to a drop in the total fertility rate from 7.7 in the 1990s to 4.1 in 2014 [1].

However, the Ethiopian Federal Ministry of Health (EFMOH) in its Health Sector Transformation Plan (HSTP: 2015-2020) envisions to further reduce maternal, neonatal, and infant mortality by more than half [2]. More specifically, The Government of Ethiopia (GOE) committed to achieving another success through Ending Preventable Child and Maternal Death (EPCMD). To achieve this ambitious plan,

need substantial investments and innovative approaches to strengthen the health system to overcome key gaps [2].

USAID Transform: Primary Health Care Activity starts its technical, financial and other resource support for over 300 woredas with three different categories [3]. The categorization was made based on selected maternal and child health indicators which include: 40 (13.0%) woredas were high performers, 95 (32.0%) woredas were medium performers and the rest 165 (55.0%) woredas were low performers [3]. To narrow these performance differences the project adopted an innovative way to strengthen the capacities and skills of the primary healthcare workforce through establishing a twinning partnership [3, 4].

This article presents the results of the twinning partnership strategy implemented for performance improvement between *Machakel* and *Bibugn* districts of Amhara region, *Dabmoya* and *Hadero-Tunto* districts of Southern, Nations, Nationalities and Peoples (SNNP) region. In addition, the article argues that a twinning partnership can help the health systems to increase the number of learning organizations in the era of woreda transformation.

## Operational Definition

A twinning partnership is defined by Cadee et al (2018) as a “cross-cultural reciprocal process where two groups of people work together to achieve joint goals” [5]. Similarly, the World Health Organization (WHO) defined twinning as a formal and substantive collaboration between two organizations [4, 6-8]. Formal means that there is a verbal or written agreement between the two organizations. Substantive means that the interaction is significant, and it lasts for a specific period i.e. it is not a one-time interaction. Collaboration means that the two organizations work together on a specific cycling project or to exchange information or skills. Ideally, twinning should be a two-way process whereby each organization benefits from the collaboration [4, 6, 7].

## Materials and Methods

A case study design was employed for this study. This study was conducted in Amhara and SNNP Regions. The study conducted in four districts, namely; *Machakel*, *Bibugn*, *Damboya* and *Hadero-Tunto*, where the twinning partnership strategy implemented for more than one year. This study was conducted from April to May 2019. Data collection guides were developed based on research objectives and questions. In addition, data abstraction forms were developed based on the principles of the twinning partnership strategy implementation guidelines and measurement variables identified for health sector reforms (additional files 1, 2, 3 & 4). The data were collected using the following methods: in-depth interviews with healthcare professionals of primary health care entities and reviewing records/documents. The qualitative data were transcribed verbatim and translated into English, then manually thematically analyzed. The quantitative data were four district (woreda) management Standards where 26 standards and 81 validation criteria assessed and rated out of hundred; seventeen health centers were assessed using Ethiopian Health Center Reform Guidelines with ten chapters, 81 standards with 209 validation criteria [9] and rated out of hundred. Eighteen key performance indicators were collected from all 17 health centers where 453307 inhabitants live and rated out of hundred. Community based Health Insurance new membership and renewals was targeted 103024 households. Proportion of active membership was collected from all seventeen health centers and rated out of hundred. The data were checked for completeness and consistency and thereafter entered into the computer program Microsoft Excel 2010 [10]. Descriptive statistics was used to calculate averages, frequencies and percentage where result was

presented in figure. Permission to conduct the study was sought from selected primary health care entities and informed written consent was taken from all study participants. The researchers maintain ethical principles which include anonymity, privacy, and confidentiality of the participants.

## Results

The twinning partnership strategy was implemented for over 18 months. Table 1 below depicted the six steps followed in the implementation of the twinning partnership and current status. The first step implemented after facilitating preliminary discussions with Zone Health Department, and district health offices. This critical step [11] helps the project to get the buy-in from the implementing partners and coordinating body. The second step, needs assessment, was conducted by all four partner district health offices. Baseline data, strength, and gaps of each primary health entities were made. The third step, with the help of USAID Transform: Primary Health Care project, 59 (14 females) health workers were trained on strategic problem-solving tools and analyzed the identified gaps. The fourth step was, action plan development, completed with identifying team vision, desired measurable results, obstacles, and prioritized solutions. In addition, detail of fishbone analysis, prioritizing proposed solutions, stakeholder analysis, resource mobilization, monitoring, and evaluation plans help the twins to actively engage the next step. The fifth step was implementing the action plan stated in step four. Some of the major activities implemented by twins include preparing reciprocal experience sharing event, organize onsite and off-site technical pieces of training, facilitating coaching and learning collaboration or knowledge sharing workshop [6, 8]. In the sixth step, the project, and twins conducted a midterm evaluation and facilitated a number of performance review meetings.

## Performance improvement

Based on the health sector reform criteria, the baseline data revealed that *Bibugn* and *Hadero-Tunto* districts were classified and low performing district. While *Machakel* and *Damboya* districts were classified as medium performing district. During the midline and end-line assessment, all four districts were narrowed their performance gaps and achieved high medium and high performing status. Figure 1 below clearly depicts that Woreda Management Standards (WMS) scores [2] improved from 40.0% to 70.0%; Ethiopian Health Centers Reform Implementation Guidelines

(EHCRIGs) scores [12] improved from 58.0% to 78.0%; Key Performance Indicators (KPIs) score [2] improved from zero percent to 84.0%, and active Community-Based Health Insurance (CBHI) membership score [2] improved from 56.0% to 62.0%.

The result of the qualitative data showed that both low and medium performer districts were benefited from the partnership. The twinning partnership strategy helped districts with a difference in performance status to work together and improved their categories. The following verbatim clearly reflects the win-win relationship, level of collaboration and institutionalization of learning organizations.

“...with the twinning partnership, our organization benefited through the exchange of experts, sharing of standard operating procedures and other resources... we improved our performances in a short period of time...”

... we arranged reciprocal experience sharing event, our district council members were inspired by what they saw at our lead facility in twinning partnership. After the field lesson, the district council allocates over 20,000.00 (twenty thousand USD) to replicate the observed best practice in lead district, which was a clean and safe health facility in our district interventions...”

.... Though our woreda seam in higher performance category at the starting point of the twinning “partnership, we learned a lot from our partner for specifically, we get to know in detail how they facilitate the external auditing of health center, then we also follow similar steps and achieved our gaps...”

## Conclusion and Recommendations

Based on the result of this study the implemented twinning partnership strategies, helps partner districts to work together and achieved a higher performance category within 18 months. In addition, the partnership helps twins to institutionalize learning organization and culture of performance improvement at primary health care entities.

## References

1. Federal Ministry of Health (FMOH). Health Sector Transformation Plan (2015/16 - 2019/20) [Internet]. FMOH: Addis Ababa, Ethiopia; 2015/16 [cited 2020 Jan 28]. Available from: <https://www.globalfinancingfacility.org/ethiopia-health-sector-transformation-plan-201516-201920>
2. Federal Ministry of Health (FMOH). Woreda Transformation Implementation Manual. FMOH: Addis Ababa, Ethiopia; 2015/16.
3. USAID Transform: Primary Health Care Project. Theory of change in practice. USAID Transform: Primary Health Care, Addis Ababa, Ethiopia; 2017.

## Acknowledgements

Transform Primary Health Care Activity is a United States Agency for International Development (USAID) funded health program under cooperative agreement number of AID-663-A-17-00002. The program is implemented by a consortium of organizations which includes Pathfinder International, JSI Research and Training Institute, Inc., EnCompass, Malaria Consortium, Abt Associate Inc., and Ethiopian Midwives Association in collaboration with local Government and Non-government partners. The funder does not have any role in the design of this study, data collection, analysis and writing of the manuscript. This technical twinning partnership formative evaluation report is made possible by the generous support of the American people through USAID. The authors' views expressed in this technical report do not necessarily reflect the views of USAID or the United States Government. The investigators are indebted to all participants for their cooperation during data collection.

## Conflict of interest statement

Conflict of interest: none declared.

## Authors Contribution

The authors of this manuscript are MDA BFD, MGA, EM, TG, WK, CG and TAB made a substantial contribution to conceiving and designing the study. MDA, MGA, and EM were responsible for overseeing the field work, cleaning the data, transcribing qualitative data. MDA and BFD analyzed the data, interpreting the analysis and drafting the manuscript. All authors read the final document and approved it. MDA, the corresponding author, submitted the manuscript for publication.

4. United States Agency for International Development (USAID): Transform Primary Health Care. Implementation guidelines: Twinning partnership strategy to improve performance of woredas and primary health care units. USAID: Transform Primary health care: Addis Ababa, Ethiopia; 2017.
5. Cadée F, Nieuwenhuijze MJ, Lagro-Janssen AL, De Vries R. The state of the art of twinning, a concept analysis of twinning in healthcare. *Glob Health*. 2016;12(1):66. <https://doi.org/10.1186/s12992-016-0205-5>
6. World Health Organization. Twinning partnerships for improvement: recovery partnership preparation package: building capacity to reactivate safe essential health services and sustain health service resilience [Internet]. World Health Organization; 2016 [cited 2020 Jan 22]. Available from: <https://apps.who.int/iris/handle/10665/206542>
7. ICAD, Interagency coalition on AIDS and development. Beyond Our Borders: A Guide to Twinning for HIV/AIDS Organizations [Internet]. S.N.L.O. Calle Almedal, UNAIDS, et al., editors. Canada; 1999 [cited 2020 Jan 18]. ISBN: 0-662-28211-6. Available from: [http://www.icad-cisd.com/pdf/Twinning/Beyond\\_Our\\_Borders\\_Twinning\\_Manual.pdf](http://www.icad-cisd.com/pdf/Twinning/Beyond_Our_Borders_Twinning_Manual.pdf)
8. Partnership Preparation Package. A practical guide to implementing twinning partnerships. WHO Twinning Partnerships for Improvement [Internet]. Geneva: World Health Organization; 2018 [cited 2020 Jan 02]. Available from: <https://apps.who.int/iris/bitstream/handle/10665/273158/WHO-HIS-SDS-2018.13-eng.pdf>
9. Argaw MD, Desta BF, Bele TA, Ayne AD. Improved performance of district health systems through implementing health center clinical and administrative standards in the Amhara region of Ethiopia. *BMC Health Scrv Res*. 2019;19(1):127. <https://doi.org/10.1186/s12913-019-3939-y>
10. Microsoft Corporation. Microsoft Excel [Internet]. 2018 [cited 2020 Jan 02]. Available from: <https://office.microsoft.com/excel>
11. Saha N, Saha P. Twinning strategy: Is it a vehicle for sustainable organizational learning and institutional capacity development? [Internet]. *WSEAS Transactions on Business and Economics*. 2015[cited 2020 Jan 02];(12):317–24. Available from: <http://www.wseas.org/multimedia/journals/economics/2015/a585807-365.pdf>
12. Federal Ministry of Health (FMOH). Ethiopian health centers reform implementation guidelines. Addis Ababa: Federal Ministry of Health of Ethiopia; 2016.

## Tables

**Table 1.** Twinning partnership implementation steps and status, 2018/2019

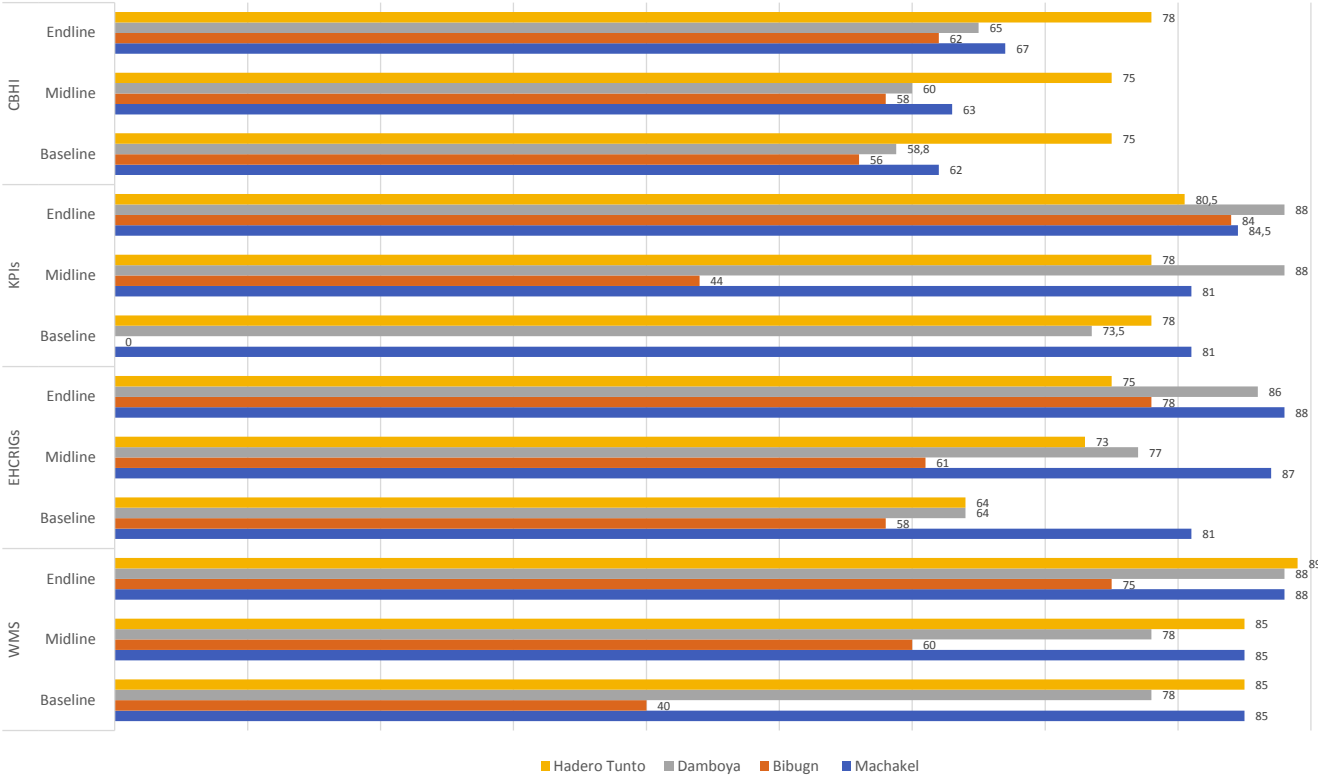
The table clearly presents the six twinning partnership implementation steps and its status during the data collection time. The first step was partnership development: is the first step of twinning partnership strategy implementation and is a critical step for the success and sustainability of the program [11]. USAID Transform: Primary Health Care Project facilitated a brief preliminary discussion with the zone health department. The assigned twinning partnership focal person facilitated the relationship building between the medium (Machakel) and low (Bibugn) performing districts in East Gojjam Zone of Amhara Region. Similarly, the event was facilitated between Medium (Damboya) and low (Hadero Tunto) performing districts of Kembata Tembaro Zone of SNNP region. The second step was needs assessment: both districts collected baseline data and the information captured was used to prioritize the intervention areas as well as to monitor and evaluate the twinning partnership strategy. The third step was gap analysis: the project facilitated a three-day training on strategic problem-solving, performance management and mentoring & communication tools. Participants recruited from partner districts attended the training. The Fourth step was action planning: through the training process, participants were engaged in scanning organization mission, identifying a team vision, major obstacles, priority activities, and developed detailed action plan. The desired measurable results for partners districts were to achieve a high-performance status. The fifth step was implementing the action plan: partner districts prepared a reciprocal experience sharing, onsite- and off-site training and implemented all agreed activities. The sixth step was review and evaluation: on site-support supervision and mutual performance review meetings were organized. Mid-year review meeting and annual evaluation are planned.

Steps	Activities	Status
Step 1	Partnership Development	
	Commitment and willingness; MOU signed; Focal Person assigned; budget allocated	Completed
Step 2	Need Assessment	
	Baseline; Strength and Gap identification	Completed
Step 3	Gap Analysis	
	Strategic Problem-Solving and Gap Analyzed	Completed
Step 4	Action Planning	
	Developed shared vision; desired measurable results (goal), obstacles, prioritized solution, stakeholder analysis, resource mobilization develop twinning projects	Completed
Step 5	Action/implementation	
	All four districts prepared a reciprocal experience sharing event; organize onsite and off- site training; coaching and mentoring;	Completed
Step 6	Review and Evaluation	
	Organize knowledge sharing events; midterm and end term review	Partially completed



# Figures

**Figure 1.** Baseline, Midterm and End-line scores of twinned districts May 2019  
Each bin represents the average score by district against District (Woreda) Management Standards, Ethiopian Health Center Reform Implementation Guidelines, key Performance Indicators and Community-Based Health Insurance at three point in time measurements. The chart clearly shows the significant positive improvements on district management standards; Key Performance Indicators and Ethiopian Health Center Reform Guidelines.



## Supplemental Data

### District (Woreda) Management Standards

Governance and Organizational Capacity				
<b>WM1</b>	<b>The organizational structure of the Woreda Health Office reflects its core functions. The organizational structure of the woreda health office has core processes and case teams responsible to execute the following core functions.</b>	<b>Data Source</b>	<b>Indicate</b>	<b>Met, Unmet</b>
	<ul style="list-style-type: none"> <li>a. Planning, monitoring and evaluation of health promotion, disease prevention and curative health care activities in the woreda.</li> <li>b. Coordinating mentoring and technical support among Primary Health Care Facilities, (Primary Hospital, Health Centers and Health Posts)</li> <li>c. Planning and coordinating supportive supervision of Primary Health Care Facilities, and monitor quality of service.</li> <li>d. Coordinate resource mobilization for primary health care.</li> <li>e. Ensuring community engagement and ownership</li> <li>f. Disease surveillance and coordinating and planning. emergency response for public health emergencies.</li> <li>g. Conducting regulatory functions.</li> <li>h. Coordination with other sectors at the woreda level.</li> <li>i. Provision of oversight on finance, human resources infrastructure and supplies to Primary Health Care Facilities.</li> </ul>	Indicated in the Woreda health office organogram, adequate staff working in these function are available. Reports indicating these functions in past quarter are available at woreda health office.		
<b>WM 2</b>	<b>Woreda Health Office ensures governing boards of Primary Health Care Facilities (HCs, PHs) are functional.</b>	<b>Data Source</b>	<b>Indicate</b>	<b>Met, Unmet</b>
	<ul style="list-style-type: none"> <li>a. All governing boards meet monthly. Woreda health office, presenting the case to the woreda administration, ensures that corrective action is taken on governing boards that do not meet monthly.</li> <li>b. Minutes of governing board meetings include; review of action points from previous meeting, performance review using KPIs and way forward action points</li> <li>c. Financial and programmatic performance targets are reviewed using facility-level Key Performance Indicators (KPIs), quarterly.</li> </ul>	Governing board meetings reports and minutes for meeting conducted in past quarter indicate these activities and the reports are available at woreda health office		
<b>WM 3</b>	<b>Coordination and communication among governing boards of Primary Health Care Facilities.</b>	<b>Data Source</b>	<b>Indicate</b>	<b>Met, Unmet</b>
	<ul style="list-style-type: none"> <li>a. Woreda Administrator organizes quarterly joint meeting of all governing board representatives from Primary Hospitals (PHs) and Health Centers (HCs).</li> <li>b. Minutes of governing board joint meetings include; review of action points from previous meeting, performance review using KPIs and way forward action points.</li> <li>c. Priorities of governing boards are defined, financial and programmatic performance targets are reviewed, using KPIs combined from Primary Health Care Facilities.</li> </ul>	Joint governing board meetings minutes conducted in past quarter indicates this activity took place and report available at woreda health office		

<b>WM 4</b>	<b>Woreda health office and Primary Health Care Facilities is led by qualified personnel</b>	<b>Data Source</b>	<b>Indicate</b>	<b>Met, Unmet</b>
	<ul style="list-style-type: none"> <li>a. Woreda health office head has educational qualification and experience based on requirements of Ethiopian civil service guidelines.</li> <li>b. PHCU Directors have educational qualification and experience based on requirements of Ethiopian civil service guidelines.</li> <li>c. CEOs of primary hospitals have educational qualification and experience based on requirements of Ethiopian civil service guidelines.</li> <li>d. All primary health care facility and woreda managers have certificate-based, on-the-job management, leadership, problem solving training.</li> </ul>	HR personal profile of staff indicates the requirement		
<b>WM 5</b>	<b>Woreda health office ensures Primary Health Care Facilities are staffed.</b>	<b>Data Source</b>	<b>Indicate</b>	<b>Met, Unmet</b>
	<ul style="list-style-type: none"> <li>a. Woreda health office keeps updated record of staffing of; woreda health office and Primary Health Care Facilities (filled positions and vacancies)</li> <li>b. Woreda health office ensures that woreda health office and Primary Health Care Facilities are staffed with the required number and qualification of staff.</li> <li>c. Woreda health office ensures equitable allocation (professional mix and number) of health professionals among the Primary Health Care Facilities in the woreda based on patient volume.</li> <li>d. woreda health office recognizes and motivates high performing woreda health office and primary health care facility staff.</li> </ul>	HR records and reports of the woreda and primary health care facilities in last quarter indicated the stated activities		
<b>WM 6</b>	<b>Woreda health office ensure adequate finance allocation and provides financial oversight to Primary Health Care Facilities(Budget vs actual reports compiled by the woreda health office)</b>	<b>Data Source</b>	<b>Indicate</b>	<b>Met, Unmet</b>
	<ul style="list-style-type: none"> <li>a. Woreda health office secures a minimum of 15% budget allocation to health from the total woreda level government expenditure.</li> <li>b. Woreda health office reviews income statements and balance sheets, and provides feedback to all Primary Health Care Facilities quarterly.</li> <li>c. Woreda health office monitors execution of internal financial audits of Primary Health Care Facilities every six months.</li> <li>d. Woreda health office in coordination with woreda finance plans and executes external financial audits for all Primary Health Care Facilities annually.</li> </ul>	Woreda health office annual, biannual and quarter financial reports indicated the activities enlisted		
<b>WM 7</b>	<b>Woreda health office provides oversight and facilitates procurement of goods and services by Primary Health Care Facilities.</b>	<b>Data Source</b>	<b>Indicate</b>	<b>Met, Unmet</b>
	<ul style="list-style-type: none"> <li>a. Woreda health office compiles procurement needs (goods and services) including essential drugs by each primary hospital and health centers.</li> <li>b. Woreda health office monitors that procurement are executed timely by primary hospital and health center and maintains checklist showing list of items requested vs procured.</li> <li>c. Woreda health office has ensured implementation of LMIS (Logistics Management Information System) in Primary Health Care Facilities.</li> <li>d. The Woreda health office oversees zero stock out rates across all essential drugs Primary Health Care Facilities.</li> </ul>	Woreda health office procurement plan, activities and supervisions report indicated the activities are conducted in past quarter		

<b>WM 8</b>	<b>Woreda health office ensures that Primary Health Care Facilities have basic infrastructure requirements: buildings, communications, electricity and water.</b>	<b>Data Source</b>	<b>Indicate</b>	<b>Met, Unmet</b>
	<ul style="list-style-type: none"> <li>a. Woreda health office keeps a record of status of buildings, communications, electricity, and water availability for each primary health care facility.</li> <li>b. Woreda health office develops a plan of action in consultation with facility governing boards, Woreda Administration and other relevant stakeholders to fill identified infrastructure gaps in building, communications, electricity, and water.</li> </ul>	Woreda health report and plan of action indicates the activities are conducted in the last 6 months		
<b>Service Delivery</b>				
<b>WM 9</b>	<b>Woreda health office ensures availability of essential package of basic health care services at Primary Health Care Facilities (Review of essential package of services, site visits of facilities).</b>	<b>Data Source</b>	<b>Indicate</b>	<b>Met, Unmet</b>
	<ul style="list-style-type: none"> <li>a. Woreda health office maintains an updated record of essential package of basic health care services available in each Primary Health Care Facilities.</li> <li>b. Woreda health office ensures essential package of basic health care services are available in each Primary Health Care Facilities.</li> </ul>	Woreda health office service directory profile updated every quarter on basic health care services provision at health facilities		
<b>WM 10</b>	<b>There is a referral and linkage system between Primary Health Care Facilities in the woreda.</b>	<b>Data Source</b>	<b>Indicate</b>	<b>Met, Unmet</b>
	<ul style="list-style-type: none"> <li>a. All Primary Health Care Facilities use standard referral protocol including standard referral forms and registers.</li> <li>b. Woreda health office organizes referral feedback meeting quarterly between Primary Health Care Facilities where data on referral, feedback, and unnecessary referrals are reviewed.</li> <li>c. Ambulance administration policy is in place and operational.</li> </ul>	Referral feedback meetings conducted last quarter and minutes showed all facilities uses standard referral protocol and ambulance policy utilization is functional.		
<b>WM 11</b>	<b>Woreda health office coordinates quarterly clinical audits in all Primary Health Care Facilities to ascertain adherence to clinical guidelines, SOPs.</b>	<b>Data Source</b>	<b>Indicate</b>	<b>Met, Unmet</b>
	<ul style="list-style-type: none"> <li>a. Woreda health office identifies clinical audit areas for each primary health care facility in collaboration with Primary Health Care Facilities.</li> <li>b. Woreda health office monitors Primary Health Care Facilities conduct clinical audits on the areas identified quarterly.</li> <li>c. Woreda health office ensures implementation of quality improvement activities in all Primary Health Care facilities based on clinical audit findings.</li> </ul>	Clinical audit report conducted in the last quarter and prepared quality improvement plan based on clinical audit		
<b>WM 12</b>	<b>Woreda health office coordinates clinical mentoring between primary hospital and health centers.</b>	<b>Data Source</b>	<b>Indicate</b>	<b>Met, Unmet</b>
	<ul style="list-style-type: none"> <li>a. Woreda health office working with the CEO of Primary Hospital organizes clinical mentoring sessions between primary hospital and all health centers monthly. (Clinical mentoring may include one-on-one case management and observation, chart reviews, attachments, and didactic sessions).</li> <li>b. Woreda health office organizes knowledge and skills assessments of mentees semi-annually in collaboration with primary hospital to monitor the outcome of mentoring.</li> <li>c. Woreda health office organizes trainings or mentoring sessions in collaboration with the primary hospital based on knowledge and skills gap identified.</li> </ul>	Woreda health office and hospital CEO developed quarterly clinical mentoring schedule and document the activity report		

<b>WM 13</b>	<b>Monitor outbreak and public health emergencies (Surveillance report and Emergency response plan)</b>	<b>Data Source</b>	<b>Indicate</b>	<b>Met, Unmet</b>
a.	Case surveillance for reportable diseases is in place.	Case surveillance and reportable disease report made monthly in the last quarter and Public health emergency plan prepared		
b.	Resources and systems to respond to public health emergencies are in place.			
<b>Community engagement</b>				
<b>WM 14</b>	<b>Community are organized in 1-5 networks and developments teams (Health Development group command post reports).</b>	<b>Data Source</b>	<b>Indicate</b>	<b>Met, Unmet</b>
a.	All health development teams and 1-5 network leaders have undergone training and started implementation of activities.	Health development team and 1-5 network quarter activity report review		
b.	All health development teams are functional (meet regularly and document minutes of meetings).			
c.	All health development team leaders are accredited to level 1 qualification.			
<b>WM 15</b>	<b>All kebeles in the woreda are verified as model in health service delivery.</b>	<b>Data Source</b>	<b>Indicate</b>	<b>Met, Unmet</b>
a.	Woreda health office compiled and analyses health extension package performance of all kebeles and categorizes them into; high, middle and low performers.	Health development team and 1-5 network quarter activity report review		
b.	Woreda organizes annual mobilization (ignition) meeting with the community focusing on creation of model kebeles.			
c.	Woreda health office monitors model kebele initiative performance quarterly.			
<b>WM 16</b>	<b>Establish and maintain community feedback mechanisms (Town hall meeting minutes and Community score card report).</b>	<b>Data Source</b>	<b>Indicate</b>	<b>Met, Unmet</b>
a.	Woreda health office working closely with the woreda administration, Health Centers and Primary Hospitals organizes quarterly community town hall meetings where community provides feedback on quality and access to services.	Woreda health office conducted community score card and town hall meeting in the past quarter		
b.	A system of community score card is established and maintained at Primary Health Care Facilities quarterly.			
c.	Woreda health office in consultation with Primary Health Care Facilities, coordinates the implementation of activities responding to feedback from the community quarterly.			
<b>WM 17</b>	<b>Woreda starts and maintains Community Based Health Insurance (CBHI) scheme.</b>	<b>Data Source</b>	<b>Indicate</b>	<b>Met, Unmet</b>
a.	The woreda meets and maintains minimum community enrollment to start CBHI.	Woreda met minimum community enrollment rate and conducted CBHI coordination meeting in the last quarter		
b.	Woreda health office in collaboration with woreda administration organizes quarterly meetings with CBHI agency, PHC facilities, and kebele administration to review progress on CBHI.			
<b>WM18</b>	<b>Woreda health office coordinates community contribution and ownership on community based public health interventions.</b>	<b>Data Source</b>	<b>Indicate</b>	<b>Met, Unmet</b>
a.	woreda health office has identified health projects which can be implemented with monetary and in-kind support from the community.	Woreda coordinated and reported back to the community in monetary and in-kind community contribution for infrastructure projects in the last quarter		
b.	Woreda health office coordinates monetary and in-kind community contributions in infrastructure projects such as building health posts, HEW residences, community latrines, maternity waiting areas, and other projects.			
c.	Woreda health office oversees and coordinates all monetary and in-kind contributions of the community and reports back to community on achievements.			

Coordination with other key sectors in the Woreda				
WM 19	Inter-sectoral coordination mechanisms established.	Data Source	Indicate	Met, Unmet
	<ul style="list-style-type: none"> <li>a. Woreda health office ensures integration of health sector related activities with other sectors' plans such as education, agriculture, infrastructure, electricity, water, finance, civil service, and others.</li> <li>b. Woreda health office implemented joint planned activities with other sectors.</li> <li>c. Woreda level inter-sectoral steering committees monitor jointly planned activities and makes decisions to address potential bottlenecks quarterly.</li> </ul>	Woreda reported to cabinet on intersectoral collaboration and presented planned jointly activities quarterly. Minutes of inter-sectoral steering committee meetings.		
WM 20	Coordinate and align activities of development partners, and civil society organizations.	Data Source	Indicate	Met, Unmet
	<ul style="list-style-type: none"> <li>a. Woreda health office maintains updated mapping of development partners, and civil society organizations working in the health sector.</li> <li>b. Woreda health office works with the woreda administration to organize joint planning and review meetings with development partners, and civil society organizations working in the health sector quarterly.</li> </ul>	Updated partner map available and quarterly partners joint planning and review meetings made		
WM 21	Private health facilities work in alignment with priorities of the woreda and operate within the national regulatory framework.	Data Source	Indicate	Met, Unmet
	<ul style="list-style-type: none"> <li>a. Woreda health office has included all private facilities related with the health sector in the woreda such as; private health facilities, food and drink provides, schools, industrial sites, etc. in its regulatory plan.</li> <li>b. Woreda health office organizes periodic inspections in private facilities based on FMHACA regulatory standards and set up a system for follow-up.</li> <li>c. Woreda health office organizes joint consultations with private facilities semi-annually.</li> </ul>	HMIS report from private sectors collected in all months of last quarter, bi-annual consultative meeting with private health facilities workers conducted, FMHACA based inspection conducted in the last quarter		
Performance Management				
WM 22	Woreda health office develops woreda based plan and targets.	Data Source	Indicate	Met, Unmet
	<ul style="list-style-type: none"> <li>a. Woreda health office develops 5-year strategic plan for health.</li> <li>b. Woreda health office develops woreda based annual plan and targets aligned with strategic plan and allocates targets to Primary Health Care Facilities.</li> <li>c. Woreda health office organizes quarterly review meetings with the participation of Primary Health Care Facilities and stakeholders to review implementation of activities and provide feedback.</li> </ul>	Five year strategic plan and woreda based plan developed and reviewed in the past quarter		
WM 23	System for performance review established and operational in Primary Health Care Facilities.	Data Source	Indicate	Met, Unmet
	<ul style="list-style-type: none"> <li>a. Woreda health office and all Primary Health Care Facilities staff conduct monthly performance reviews based in balanced score card and semi-annually 360 performance evaluations.</li> <li>b. Woreda health office monitors implementation of result oriented performance review in Primary Health Care Facilities semi-annually and ensure performance review results are used for human resource and management decisions.</li> </ul>	360 performance review report. PHC facilities peer performance review and result oriented performance review reviewed by woreda health office and used for human resource and management decision		



WM 24	Performance of Primary Health Care Facilities is monitored using evidence from; KPIs, EHRIG, EHCRIg.	Data Source	Indicate	Met, Unmet
a.	Woreda health office and primary health facility managers and boards use KPIs to monitor performance and take corrective action on a monthly basis.	PHC facilities uses KPI, HMIS, EHRIG and EHCRIg in the last quarter and HMIS LQAS conducted at least once		
b.	Woreda health office makes quarterly EHRIG, EHCRIg assessments of PH and HCs.			
c.	Woreda health office monitors HMIS data including; timeless, quality, and completeness of data in each of the Primary Health Care Facilities and provide feedback on a quarterly basis (LQAS).			
WM 25	Woreda health office compiles and disseminates national and regional policies, guidelines and manuals used as references for performance management.	Data Source	Indicate	Met, Unmet
a.	Woreda health office compiles and disseminate national and regional policies, guidelines, and manuals to all Primary Health Care Facilities.	Woreda health office made last quarter check on availability of national and regional guidelines, policies and manuals at PHC facilities		
b.	Woreda health office monitors availability of a list of policies, guidelines and manuals at Primary Health Care Facilities quarterly.			
Monitoring and supervision by woreda				
WM 26	Supportive supervisions to Primary Health Care Facilities (Supportive supervision report)	Data Source	Indicate	Met, Unmet

**Additional file1: Quasi-experimental assessment tool**

Instruction:

The questionnaire has 4 pages containing 81 questions divided among 10 chapters. First you will find the informed consent. First assess the validation criteria and then if all positive (Yes) score 1 (met) for the standard otherwise score zero (not met).

**Chapter 1: Health Center Leadership, Management & Governance**

**Checklist: chapter I.**

Ser. No	Description of the standard	Verification Criteria	Yes ✓ No x	met =1 not met =0	Remark / comment
1	The Health Center Governing Board has been Established.	Board members assigned with letter.  Gender balance maintained in board members.  Governing board established in accordance with a legislation with minutes.  Governing Board developed its Term of References (TOR) and approved by all members  Governing board has annual plan.			
2	The Health Centre has a functional Governing Board (GB) meets regularly to oversee the overall operations and service delivery of the health Centre.	Minutes available.  check availability of all agendas.  All board members attended the meetings regularly.  Governing board members officially invited by health center head.  Agenda shared two days earlier than the meetings			
3	The Health Center Governing Board approved strategic and annual plans, monitor achievements against goals on quarterly bases.	Minutes of approval for strategic and annual plans.  Proceeding of review meetings on performance reports.  Feedback given.			
4	Health Center Director has been appointed by the mayor or head of woreda council; health Centre management team represents various departments.	Testimony of official assignment of health Centre director.  List of health Centre management team members.  Minutes of health Centre management team/committee.  Management committee had Term of Reference (TOR) and held regular meetings as per the bylaw.			
5	The Health Centre Director is evaluated against the goal of the management committee biannually.	Performance appraisal of health Centre director  Proceeding / minutes of Performance appraisal assessment of Health Centre Director.			
6	The Health Centre Director has got approval of management committee, GB and before submit report to woreda health office.	Monthly submitted reports to Woreda Health Office.  Proceedings of performance evaluation  Implementation of plans  Feedbacks			
7	Exempted services are provided and information about the services is posted n appropriate places in the Health Center and there are bilingual fee posters in each service area.	Menu of services with its cost publicly posted using local language			

8	The Health Center signed Memorandum of understanding on credit and waived services with stakeholders.	List of patients benefited from waiver services. Patients benefited from the services Signed MOU and effected payments.
9	Health Centre Finance Officer prepares and sends monthly reports to appropriate bodies.	Financial Reports and records Minutes Management Committee feedbacks Balance Sheets
10	The Health Center has a procurement plan approved by HC Governing Board.	GB approved Procurement Plan
11	The Health Center has GB approved accounting manual.	Approved accounting procedure and manual.
12	Every Year External audits are conducted by Finance Office; reports are reviewed by the SMT.	Audit report Feedbacks given on audit reports

**Chapter 2: Health Center and Health Post Linkage**

**Checklist: chapter 2**

Ser. No	Description of the standard	Verification Criteria	Yes ✓ No x	met =1 not met =0	Remark / comment
1	Terms of reference developed for Health center and Health post linkage and assigned one focal person who is responsible to follow-up the implementation process.	Health Center Health Post Linkage implementation manuals Share Action Plan on Linkage Officially assigned focal person			
2	Strengthen the Women development army and 1-5 network at all catchment Kebeles and make it fully functional.	Health Center _Kebeles Linkage documents Check the competency assessment documents of 1 - 5 network members (See Criteria in the guidelines)			
3	Annual plan and budget was developed for HC and its Catchment HP as PHCU.	Share Annual Plan with Budget Proceeding or reports on PHCU plan familiarization workshop Minutes			
4	The health center was collecting weekly plan and report from each catchment HP then provided feedback to HPs.	Plan - versus achievement reports Feedbacks given			
5	The HC staffs were supporting the HPs regularly on weekly bases using standards checklist.	Weekly schedules Standard Checklists Performance Improvement plan developed after TA			
6	The HC in the presence of HEWs was evaluated its performance on months bases and documented best practices and scaling it up	Minutes Documented best practices			

7	The HC was identified bottlenecks in terms of awareness, skills of HEWs and supplies. Then, the HC was provided capacity enhancement interventions for HEWs.	Identified awareness, skill and supply gaps  Feedbacks  Evidence of Capacity enhancement interventions
8	The HC was providing all Essential Drugs and supplies for their satellite HPs. Monitor the proper utilization of drugs and supplies.	Drugs and equipment's  Supplies  Monitoring system in place

**Chapter 3: Patient Flow and Services Organization**

**Checklist: chapter 3.**

Ser. No	Description of the standard	Verification Criteria	Yes ✓ No x	met =1 not met =0	Remark / comment
1.	Health Center service flow procedural manual was developed. Which mainly focus on OPD, Emergency and Delivery service points and decrease patient load in the HC.	Check and observe the following criteria  Patient flow Procedure  Triage protocol  Patient 24 hours services and discharge protocol  Referral protocol  Referral feedbacks  As per the standards of FMHACA check availability of drugs and medical equipment's in emergency, delivery and units			
2.	All Health Center Staffs were aware of the patient flow procedure and protocols and properly implemented it.	Randomly select five health Centre staff and check their knowledge and skill with regards to patient flow and referral services.			
3.	There is a patient triage services with trained personnel, necessary materials and equipment's.	Patients who needs emergency services are identified and got priority services. (check with color of cards and services rendered in the facilities)  Check the presence of trained staff in the Triage/ Emergency unit  As per the standards of FMHACA check availability of sufficient drugs and medical equipment's in the emergency units			
4.	There is a written protocol for liaison and patient referral services (receiving into the health Centre and referring outside of the health Centre). The staffs are trained and properly implemented the protocol.	There is presence liaison  The necessary tools and materials ( phone, registers, referral forms etc. ) availed.  There is referral directory  There is patient appointment logbook at OPD.  In all OPD rooms, there are functional patient appointment system.			
5.	There is labelled direction with pointer displays/ indicates services and location in the HC compound to help the patients ease access to and facilitate free movements in patient care.	There is labeled direction with pointer in the health Centre compound.  Emergency and Delivery Units labels ate bold and visible to beneficiaries.  There is ambulance parking area  There is assigned receptionist			

6. The is maternal waiting homes with the facilities (toilet, water supplies, electricity), supplies and equipment's
- Check the availability of the following facilities, supplies and equipment's in Material Waiting homes.
- Toilets and shower
  - Electricity and water supply
  - Kitchen and utensils
  - Bed, Bed linens, blanket

**Chapter 4: Medical Record Management**

**Checklist: chapter 4.**

Ser. No	Description of the standard	Verification Criteria	Yes ✓ No x	met =1 not met =0	Remark / comment
1.	The Health Center has a single, unified registration system with Master Patient Index for all patients/clients, including out-patients, emergency admissions, chronic care clinics and preventive and promotive services. Each and every patient will have unique Medical Record Number. with a single,	<p>Check the presence of a single unified registration room.</p> <p>Check easiness of MPI and search for patient card.</p> <p>Check whether every and each patient has unique identifiers</p>			
2.	The Health Center utilizes a paper-based or computer-based system to track where the medical record is located at all times. The health center uses a standardized and uniform set of forms that comprise a complete medical record for the duration of a patient's/client's care.	<p>Check the presence system to locate patient card.</p> <p>MPI-Box( in alphabetically order)</p> <p>Computerized registration</p> <p>Tracer card</p> <p>Shelves with clear label to store cards in order.</p>			
3.	The Health Center has medical records management guidelines for proper handling and confidentiality of medical records	<p>Check Patient medical record management guidelines and its confidentiality in implementation.</p> <p>Presence of delivery notes.</p> <p>Focal person assigned to manage medical records inline with forensic matter, and stored in locked cabinets.</p>			
4.	The Health Center has organized orientation session, experiences sharing events, and continuous capacity enhancement training programs for medical records personnel so as they can effectively and efficiently execute their assignments.	<p>Training manuals</p> <p>All medical record personnel should be trained (Check with attendance and other records like schedule etc.)</p>			

**Chapter 5: Pharmacy Services**

**Checklist: chapter 5.**

Ser. No	Description of the standard	Verification Criteria	Yes ✓ No x	met =1 not met =0	Remark / comment
1	The Health Center has a functional Drug and Therapeutics Committee (DTC) which implements various measures designed to promote the rational, safe and cost-effective use of medicines and other supplies.	<p>There is DTC</p> <p>The DTC has developed Terms of References (TOR)</p> <p>Selection of members of DTC is in line with the guidelines</p> <p>The DTC has Annual Plan</p> <p>Minutes and reports</p>			
2	The Health Center has a separate pharmacy department comprising dispensaries and medical store directed by a registered Pharmacist and Pharmacist/Pharmacy technician respectively.	<p>Check testimonies of certification licensures ( pharmacist and pharmacy technicians)</p> <p>Letter of assignment</p>			
3	The Health Center has a health facility specific list of medicines classified by VEN that contains all Drugs, Medical Supplies, consumable-Medical equipment's and Reagents. The List shall be reviewed and updated annually.	<p>List of drugs and supplies using VEN</p> <p>Updated list for the year</p>			
4	The Health Center ensures that all 3 types of drug transactions and patient-medication related information are properly recorded, documented and auditable. A1 + ስርዓት ይኖረዋል	<p>Forecast</p> <p>Procurement and Use</p> <p>Disposal reports</p>			
5	The Health Center has policies and procedures for identifying and managing drug use problems, including: Identifying and reporting adverse drug reactions, and prescription monitoring	<p>Take 10 sample prescription and check the following points :-</p> <p>Date</p> <p>MRN</p> <p>Diagnosis</p> <p>Prescribers name, qualification &amp; signature</p> <p>Dispenser name &amp; signature</p> <p>Record the information on drug registration form.</p>			
6	The Health Center provides access to drug information to both health care providers and patients in order to optimize drug use.	<p>Drug information center established</p> <p>Check evidences of service rendered on drug information (Leaflets, posters, etc.)</p>			
7	The Health Center has policies and procedures for identifying and managing drug use problems, including: Identifying and reporting adverse drug reactions, and prescription monitoring.	<p>Policy and steps available</p> <p>Reported Side effects and other health problems with feedback</p>			



8	The Health Center has a supply and inventory management system for drugs, medical supplies and consumable equipment's approved by the DTC that describes methods of drug selection, prioritization, quantification, procurement, storage, distribution and use which is in line with national guidance.	Drug and supplies recording system / manuals  Bin card  Stock card
9	The Health Center conducts a physical inventory of all pharmaceuticals in the store and each dispensing unit at a minimum once a year.	Check annual inventory report
10	The Health Center ensures proper and safe disposal of pharmaceutical wastes and expired drugs in line with national guidance.	Drugs and supplies disposal manual  Check list of drugs and supplies disposed as per the guidelines
11	The health Centre's pharmacy team assists and monitors pharmaceutical management activities at the health posts.	Supervision and monitoring plan & report  Feedback
12	All Units of the pharmacy service have adequate personnel, equipment, premises and facilities required to store drugs, medical supplies and equipment's and carry out dispensing, and counselling services	As per FMHACA standards ensure availability of HR, Supplies and infrastructures.
13	The Health Centre conducts audits of all drugs, medical supplies and consumable equipment in the store and in each dispensing unit at a minimum bi annually by internal auditor and once a year by external auditor	Audit Report

**Chapter 6: Laboratory Services Management**

**Checklist: chapter 6.**

Ser. No	Description of the standard	Verification Criteria	Yes ✓ No x	met =1 not met =0	Remark / comment
1	Current list of laboratory tests provided by the facility with the price of each test is accessible to all clinical staff and patients.	List of laboratory services with cost posted  The service or test and estimated time posted to beneficiaries.			
2	The laboratory management strive to meet the needs and requirements of customers on informing the test reports.	Laboratory professional assigned to counsel patients on lab test results			
3	The health Centre laboratory have adequate number of staff, necessary space, and materials for work.	As per the EFMHACA standards the necessary work space is available .  Number of staff  Laboratory supplies.			

4	The laboratory have standard and system for resource management that prevent over or under stock.	Stock management system in place  Check the bin card, and stock card for completeness and updates.
5	The laboratory has standard operating procedures (SOPs) and follows it properly. Ex sample collection, transport, storing and disposal SOPs.	Check the presence of the following SOPs a. Sample collection b. Steps and procedures of laboratory services c. Algorithm d. Safety procedure and medical waste disposal system e. Laboratory equipment maintenance and follow up checklist f. Quality Assurance Scheme with clear steps g. Laboratory record system established h. Sample Collection , acceptance transport, storing and disposal SOPs available.
6	The SOPs in place ensure the safety and protection of patients and health care providers in the Health Centre during sample collection, rejection, transport, storing and disposal. The laboratory work environment is organized and clean at all times.	Safe and clean work environment  The sample collection, handling and transportation activities are safe for patients and health workers.
7	The laboratory have a health and safety manual with procedures that include different types of actions. This includes chemical exposure and fire accident prevention.	There is safety manual  There is fire extinguisher or sand to fight  Safety training staff
8	There is an established policy for data safety, confidentiality, protection period disposal and information management.	Check presence of data management manual.
9	The laboratory have and implements a quality assurance policy that covers all aspects of laboratory functions.	Continuous IQA and EQA participation

**Chapter 7: Safe Health Facility**

**Checklist: chapter 7.**

Ser. No	Description of the standard	Verification Criteria	Yes ✓ No x	met =1 not met =0	Remark / comment
1.	Health Center Management shall supports efforts in infection prevention; technical capacity, financial and human resources required for clean and safe health facility key activities.	Allocated budget for Infection prevention  There is assigned focal person			
2.	A designated committee and individual(s) are in place to effectively coordinate the implementation and monitoring of infection prevention activities.	Established Committee with approved TOR  Action plan of IP committee - approved with minutes			

3.	The health center prepares, implements, and monitors a comprehensive operational plan that addresses activities and guidance on Infection prevention and patient safety practices.	Proper guidance on implementation of infection prevention and ensure availability of essential supplies and equipment's.
4.	The health center should support the implementation of safe and clean health facility standards under its satellite to the health extension program (HEP) and health extension workers.	Evidence of technical support to Health Extension Workers to implement Clean and Safe health facility initiatives; feedback given during implementation.
5.	The health center ensures that equipment, supplies and facilities/infrastructure necessary for effective implementation of infection prevention standards	The following equipment's, tools and supplies should be available. adequate Sweepers and Mops Soap, Omo etc. Tools essential for gardening
6.	All health center staff (support and professionals) should be trained using standard infection prevention training materials.	Standard IP training manual All staff (Support and health professionals) trained : attendance list
7.	The health center provides health education to patients, caregivers and visitors, as appropriate on infection prevention practices.	Check Health Education schedules Check presence of regular IP Health Education at OPD (report/record)
8.	Standard practices to prevent, control and reduce risk of health care associate Infections (HCAIs) are in place and transmission based precautions (TBP) are adequately addressed	Check the proper medical waste sorting, collecting and disposal practices implementation.
9.	The Health center ensures that equipment, supplies are cleaned as per the standards for infection prevention	Check the implementation of proper decontamination, cleaning, sterilization and storing practices
10.	Health center and health post IP&PS activities are integrated, ensure community engagement through HEWs and 1 to 30 Women Development team.	Check activities implemented at satellite health posts, health extension workers and community members.

**Chapter 8: Medical Equipment Management & Biomedical Engineering**

**Checklist: chapter 8.**

Ser. No	Description of the standard	Verification Criteria	Yes ✓ No x	met =1 not met =0	Remark / comment
1	The Health Centre has a paper-based or computer-based inventory management system that tracks all equipment included in the equipment management program.	Check presence of inventory reports			

2	All new equipment undergoes acceptance testing prior to its initial use to ensure the equipment is in good operating condition. Equipment is installed and commissioned in accordance with the manufacturer's specifications.	Observe the implementation of acceptance testing through checklists.
3	All equipment users are appropriately trained on the operation and maintenance of medical equipment with standard operating procedures readily available to the user.	List of staff trained on equipment uses & maintenances.
4	There is a schedule for preventive and curative maintenance for each piece of equipment as guided by the manufacturer's recommendations and that schedule is appropriately implemented.	Check regular maintenance schedule  check implementation of maintenance services as per schedule.
5	The Health Centre compound are regularly inspected, maintained, and, when appropriate, improved to ensure cleanliness of rooms and compound's safety of patients, visitors and staff.	Regular inspection schedule maintained.
6	Potable water is available 24 hours a day, seven days a week through regular or alternate sources to meet essential patient care.	Check the presence water supply 24 hours per day, 7 days per week form regular or alternative sources.
7	Electrical services are available 24 hours a day, seven days a week through regular or alternate sources (such as generators, solar, ) to meet essential patient care.	Check the presence electric supplies 24 hours per day, 7 days per week form regular or alternative sources.
8	Maintain ace request form should be available for new and broken medical equipment's. Example: (electric, Water, environmental cleanliness, sweeper lines and air cleaning pipe maintenance should be in place).	Check presence of maintenance request, and workorder forms

---

**Chapter 9: Human Resource Management**

**Checklist: chapter 9.**

Ser. No	Description of the standard	Verification Criteria	Yes ✓ No x	met =1 not met =0	Remark / comment
1	The Health Center (HC) has a HRM case team or case worker staffed by individuals who possess management skills and experience dealing with individual personnel matters and HRM coordinator/case worker is a member of the HC Management committee.	Employment or assignment letter  List of Management committee members			

2	The HRM case team or case worker maintains a personnel file for each and every HC employee.	Randomly select five files and check the following points. Employment or assignment letter Job description
3	The HRM case team coordinator or case worker is responsible to develop HC Human Resource Development plan .	Human resource development plan
4	The HRM case team coordinator or case worker is responsible propose and implement different staff motivation strategies as an incentive and benefit packages.	Staff motivation, incentives and benefit packages
5	The HC has a performance management process in which all employees are formally evaluated at least two times per annual. And proper feedback should be given.	Select five sample files and check for evaluation and feedback
6	ID badges and appropriate uniforms are worn by employees at all times in the work place.	Every and each employs should wear badge and uniform.

**Chapter 10: Quality Improvement And Routine Health Information Management System**

**Checklist: chapter 10.**

Ser. No	Description of the standard	Verification Criteria	Yes ✓ No x	met =1 not met =0	Remark / comment
1	Health Center established committee to follow service quality, and report compilation from different service points.	Established Quality Improvement team of committee, and he committee developed TOR. Regular meetings held supported with minutes.			
2	The HC has prepared quality of service improvement plan categorized by month, quarter, biannual, and annual.	the health center has monthly, quarterly,bi-annually and annually categorized. Check all departments take responsibilities and singed agreements to comply with.			
3	The HC is implementing the quality improvement strategies on selected and major challenges that leads poor service delivery.	The health center identifies major challenges, their root causes and develop do-able action (prioritized solutions)			
4	The HC is responsible to collect, interpret, analyze, and use to improve quality of care and report to next level of the health care on selected key indicators in timely manner.	Check the report monthly, quarterly, and biannually, annually developed reports Heath Center in addition , check proceedings, or minutes of community groups and health workers meeting minutes.			
5	Client satisfaction and other quality indicators are regularly implemented and use the feedback for quality improvement of service delivery.	Check the assessment protocol and tools used to check patient levels of satisfaction.			

**Key Performance indicators adopted from EFMOH 2015**

SN	Indicator	Formula	Disaggregation	Data Sources	Reporting level	Remark	
1	Contraceptive Acceptance Rate (CAR)	<p>Number of women in reproductive age who use FP</p> <p>Number of women eligible for modern FP methods</p> <p>The cut off point for this indicator is 80%, that means if the PHCU scores 80% or above, the PHCU will get the maximum weight given to this indicator (i.e. 6). If the PHCU scores less 80%, the point it will score out of the total weight given to the indicator is calculated by multiplying the PHCU's CAR score by 6/80%. For example if the PHCU scores 30%, the weight it will score will be calculated as <math>30\% \times 6/80\% =</math></p>	x100%	---	CHIS/HMIS	Village (Kebele), PHCU, WZR, FMOH	<p>CT=80%</p> <p>Maximum point is 6</p>
2	Proportion of pregnant women attending antenatal care clinics tested for syphilis.	<p>Number of pregnant women tested for syphilis</p> <p>Total number of pregnant mothers attended at least one ANC visit</p> <p>In order to calculate the weight the HC would score in this indicator, the value of the indicator need to be calculated by multiplying by 5 and dividing by 100%.</p> <p>If the HC has 80% ANC syphilis testing, then the score of the health center would be <math>80\% \times 5/100\% = 4</math></p>	x100%		HMIS	Kebele, PHCU, WZR, FMOH	<p>CP=100%</p> <p>Maximum point 5</p>
3	Proportion of births attended by skilled health personnel	<p>The number of births attended by skilled health personnel</p> <p>Total number of expected Deliveries</p> <p>The cut off point for this indicator is 85%, that means of the PHCU scores 85% or above, the PHCU will get the maximum weight given to this indicator (i.e. 8). If the PHCU scores less 85%, the point it will score out of the total weight given to the indicator is calculated by multiplying the PHCU's achievement by 8/85%. For example if the PHCU scores 60%, the weight it will score will be calculated as <math>60\% \times 8/85\% = 5.6</math></p>	x100%	--	HMIS	Kebele, PHCU, WZR, FMOH	<p>CT=85%</p> <p>Maximum point is 8</p>
4	Proportion of women who attended post-natal care at least once during the early post-partum period (within 7 days after delivery).	<p>Number of postnatal visits within 7 days of delivery</p> <p>Total number of expected Deliveries</p> <p>The cut off point for this indicator is 95%, that means if the PHCU scores 95% or above, the PHCU will get the maximum weight given to this indicator (i.e. 5). If the PHCU scores less 95%, the point it will score out of the total weight given to the indicator is calculated by multiplying the PHCU's achievement by 5/95%. For example if the PHCU scores 60%, the weight it will score will be calculated as <math>60\% \times 5/95\% = 3.2</math></p>	x100%		HMIS	Kebele, PHCU, WZR, FMOH	<p>CT=95%</p> <p>Maximum point 6</p>



5	<p>Proportion of newborns with sepsis who receive treatment for sepsis within a given period</p> <p>Estimation or targets: 10% of under one-year child is neonate &lt;2 months. And the prevalence of sepsis (VSD is 7.6% of under 2 months neonates.</p>	<p>Number of neonates treated for sepsis</p> <p>Estimated number of neonates with sepsis</p> <p>The cut off point for this indicator is 95%, that means if the PHCU scores 95% or above, the PHCU will get the maximum weight given to this indicator (i.e. 5). If the PHCU scores less 95%, the point it will score out of the total weight given to the indicator is calculated by multiplying the PHCU's achievement by 5/95%. For example if the PHCU scores 60%, the weight it will score will be calculated as <math>60\% \times 5/95\% = 3.2</math></p>	x100%	---	HMIS	Kebele, PHCU, WZR, FMoH	<p>CT=95%</p> <p>Maximum point 5</p>
6	<p>Proportion of HIV positive pregnant and lactating women who received ART (antiretroviral therapy) at ANC+L&amp;D+PNC for the first time to reduce the risk of mother-to-child transmission</p> <p>NB: no Option B+; replaced by PMTCT</p>	<p>Number of HIV positive pregnant and lactating women who received ART to reduce the risk of mother to child transmission at ANC+ L&amp;D + PNC for the first time</p> <p>Number of HIV positive pregnant and lactating women</p> <p>The cut off point for this indicator is 95%, that means if the PHCU scores 95% or above, the PHCU will get the maximum weight given to this indicator (i.e. 5). If the PHCU scores less 95%, the point it will score out of the total weight given to the indicator is calculated by multiplying the PHCU's achievement by 5/95%. For example if the PHCU scores 60%, the weight it will score will be calculated as <math>60\% \times 5/95\% = 3.2</math></p>	x100%		HMIS	Kebele, PHCU, WZR, FMoH	<p>CT=95%</p> <p>Maximum point 5</p>
7	<p>Proportion of children who had penta 1, but dropped from penta 3</p>	<p>[Number of children immunized for penta 1 ] - [Number of children immunized for penta 3]</p> <p>Number of children immunized for penta 1</p> <p>The cut off point for this indicator is 5%, the following categories will be used for rating dropouts</p> <p>(1) &lt;10% will get max 5 points</p> <p>(2) 10-15 will get 3 points</p> <p>(3) 15 – 20 will get 2 points</p> <p>(4) 20- 25 will get 1 point</p> <p>(5) &gt;25 will get zero point</p>	x100%	---	HMIS	Kebele, PHCU, WZR, FMoH	<p>CT=5%</p> <p>Maximum point 5</p>
8	<p>Fully immunization coverage for under one year children</p>	<p>Number of children received all vaccine doses before 1st birthday</p> <p>Total number of surviving infants</p>	x100%	---	HMIS	Kebele, PHCU, WZR, FMoH	<p>CT=95%</p> <p>Maximum point 6</p>

		<p>The cut off point for this indicator is 95%, that means if the PHCU scores 95% or above, the PHCU will get the maximum weight given to this indicator (i.e. 6). If the PHCU scores less 95%, the point it will score out of the total weight given to the indicator is calculated by multiplying the PHCU's achievement by 6/95%. For example if the PHCU scores 60%, the weight it will score will be calculated as <math>60\% * 6/95\% = 3.8</math></p>					
9	Iron and folic acid supplementation	Total number of Pregnant women received IFA at least 90 plus	x100%	---	HMIS	Kebele, PHCU, WZR, FMoH	CT=95%
		Total estimated number of pregnant women					Maximum point 4
10	Children attended Growth Monitoring and Promotion sessions	Number of Children less than 2 year weighted during GMP session	x100%	---	HMIS	Kebele, PHCU, WZR, FMoH	CT=80%
		Total Estimated children under 2 years					Maximum point 5
11	Proportion of all forms of TB ( <i>New and relapse</i> ) cases detected during a specified time period.	Number of all forms of TB (New and Relapse cases detected during reporting period)		---	HMIS	Kebele, PHCU, WZR, FMoH	CT=90%
		Estimated number of all forms of TB cases in the population during the same period in the PHCU					Maximum point 5
		<p>The cut off point for this indicator is 90%, that means if the PHCU scores 90% or above, the PHCU will get the maximum weight given to this indicator (i.e. 5). If the PHCU scores less 95%, the point it will score out of the total weight given to the indicator is calculated by multiplying the PHCU's achievement by 5/90%. For example if the PHCU scores 60%, the weight it will score will be calculated as <math>60\% * 5/90\% = 3.3</math></p>					
12	TB case detection contributed by community	Number of TB cases detection contributed by the community	X100%		HMIS	Kebele, PHCU, WZR, FMoH	CT=87
							Maximum point 5
	NB: count number of TB cases detected after HEWs referral	Total number of TB cases (all forms) notified during the same period					
13	Number of malaria cases per 1000 population at risk of malaria	Number of new malaria OPD + IPD cases (All malaria cases, of any species, should be included – whether clinical or laboratory diagnosis.) *1000					CT=5/1000
		The following categories will be used:					Maximum point 5
		• Malaria case load < 5 = 5pts					
		• Malaria case load 5-25=3pts					
		• Malaria case load 26-50=2pts					
		• Malaria case load 51-100=1pt					
		• Malaria case load > 100=0pt					

14	Proportion of HIV positive adults and children who are currently on ART	Number of people currently on ART  Estimated number of HIV positive adults and children eligible for ART  The cut off point for this indicator is 90%, that means if the PHCU scores 90% or above, the PHCU will get the maximum weight given to this indicator (i.e. 5). If the PHCU scores less 95%, the point it will score out of the total weight given to the indicator is calculated by multiplying the PHCU's achievement by 5/90%. For example if the PHCU scores 60%, the weight it will score will be calculated as $60\% \times 5/90\% = 3.3$	---	HMIS	Kebele, PHCU, WZR, FMoH	CT=90%  Maximum point 6
15	Viral load suppression	Number of adult and pediatric patients on ART with an undetectable viral load (<1000copies/ml) in the past 12 months  Estimated number of PLWHIV	X100%		PHCU, WZR, FMoH	CT=90  Maximum point 6
16	The number of months in which tracer drug was available averaged over all tracer drugs during the month	Sum of tracer drugs x months available in the time period  Sum tracer drugs x Sum total number of months in time period  The cut off point for this indicator is 100%, If PHCU scores less 100%, it will gain the maximum weigh. If the achievement is less than 100%, the point it will score out of the total weight given to the indicator is calculated by multiplying the PHCU's achievement by 6 For example if the PHCU scores 60%, the weight it will score will be calculated as $60\% \times 6 = 3.6$ .	x100%		Kebele, PHCU, WZR, FMoH	CT=100  Maximum point 6
17	Proportion of functional Health Development army (HDA)	Number of functional 1 to 5 network in the catchment area  Total number of HDA in the catchment area  The cut off point for this indicator is 100%, that means if the PHCU scores 100%, the PHCU will get the maximum weight given to this indicator (i.e. 6). If the PHCU scores less 100%, the point it will score out of the total weight given to the indicator is calculated by multiplying the PHCU's achievement by 6/100%. For example if the PHCU scores 60%, the weight it will score will be calculated as $60\% \times 6/100\% = 3.6$	x100%		Kebele, PHCU, WZR, FMoH	CT=100%  Maximum point 6
18	Model Village (Kebele)	Number of villages declared model  Number of villages in the catchment	x100%		Kebele, PHCU, WZR, FMoH	CT = 80  Maximum point 6

**Community-Based Health Insurance from EFMOH 2015**

SN	Indicator	Formula	Disaggregation	Data Sources	Reporting level	Remark
1	Community-Based Health Insurance	<p>Number of Household newly registered or renewed membership</p> <p>Number of household in the catchment</p> <p>The target for community basedhealth insurance membebership is enrolling and renewing atleast 80% of households in a defined catchment, village.</p>	<p>x100%</p> <p>–</p>	CBHI Scheme register	Village (Kebele), PHCU, WZR, FMOH	CT=80%

# ROLE OF ANTIGEN DETERMINANTS A AND B OF AB0 BLOOD GROUP SYSTEM IN HUMAN DISEASE DEVELOPMENT (MINI REVIEW)

F.N. Gilmiyarova<sup>1</sup>, V.I. Kuzmicheva<sup>1</sup>, N.A. Kolotyeva<sup>1</sup>, O.Yu. Kuznetsova<sup>1</sup>

<sup>1</sup>Department of fundamental and clinical biochemistry with laboratory diagnostics, Samara State Medical University, Samara, Russian Federation

## Abstract

ABO blood group system discovery was an important step in development of such areas as transplantation and transfusion medicine. At the same time understanding of fundamental role of antigenic determinants in physiological functions maintenance and pathological conditions development remained unexplained for a long time. Today it is known that A and B antigens are widely represented not only on erythrocytes membrane but also on other cells and tissues: platelets, epithelial tissue, oral and spermal fluids. Earlier authors studied metabolic and coagulation profiles, as well as blood cells composition in clinically healthy individuals on more than 180,000 donations, thus revealing group-specific features for each blood group. The review provides synthesis of association of such pathological conditions as coronary heart disease, thromboembolic complications, tumors of various localizations, inflammatory and destructive oral diseases, psychiatric and some infectious diseases with the presence or absence of antigenic determinants A and B. O (I) blood group carriers are more resistant to development of diseases, excepting *H. pylori*-associated gastrointestinal diseases. Carriers of “antigenic” blood groups A (II), B (III), AB (IV) are more susceptible to infections, cardiovascular diseases, and oncological diseases. The data presented may contribute to a personalized patient approach formation, based on antigen-associated biological variability of various signs in norm and pathology.

## Keywords

*blood groups • ABO antigen system • human diseases • H. pylori • malaria • schistosomiasis • coronary heart disease • stomach cancer • esophageal cancer • breast cancer • oral cavity diseases*

## Introduction

Nowadays studying molecular markers revealing predisposition to certain diseases that could indicate pathological process development possibility is of great importance.

In this regard, ABO system antigens are of special interest. ABO blood group system was one of the first to be discovered by K. Landsteiner and his students in 1901, for this discovery he was awarded the Nobel Prize in 1930. ABO system antigens chemical structure is presented with molecules of glycoproteins fixed on erythrocyte cytoplasmic membrane surface. The difference between blood group antigens consists in different terminal oligosaccharide chain glycans [1, 2]. Antigens of ABO system are presented not only on erythrocyte membrane surface, but also in secretory epithelium of salivary glands, gastrointestinal organs, sex glands and respiratory system. The soluble form of these antigens can be found in oral fluid, semen and other biological secrets [3].

Numerous information is currently available on blood group antigens presenting the carbohydrate component (ABO, Lewis, Secretor) and their relationship to infectious and cancer disease. Existing data enables approaches of personalized medicine in terms of diagnostics and treatment of diseases based on molecular predisposition factors [4, 5]. Earlier authors studied specific features of carbohydrate, protein, and lipid metabolism, blood cell composition [5, 6] and coagulation profile depending on ABO blood group system on more than 180,000 clinically healthy persons' donations [7]. Association between blood group type and anemia, hemophilia, pregnancy-related pathology, fetal hypotrophy was observed [8, 9].

This review summarizes research results over the past decade aimed at determining the relationship between blood group affiliation by ABO system and probability of infectious and somatic diseases.

To facilitate comprehension of this paper, we will use division of blood groups according to the ABO system into “zero” group - 0 (I), that does not contain antigens A, B, AB and “non-zero”, or “antigenic” groups, that correspond to blood groups A (II), B (III), AB (IV) in the generally accepted classification [6].

schistosomiasis, people with antigenic determinants A and B on the membrane surface of erythrocytes are more susceptible to schistosomiasis than people with 0(I) blood group, and there is no dependence between the type of schistosome and ethnicity [20].

## Infectious Diseases

Glycans play an important role as recognition molecules, explaining a likely relationship between infectious diseases and blood group affiliation. Many vertebrate species retained functional gene responsible for A and B antigens expression. Most humans, on the other hand, are genotype 0 (I) carriers, so that glycosyltransferases completing A and B antigens synthesis formation are inactivated in these persons. ABO genes polymorphism is associated with evolutionary adaptation as a protection mechanism against interspecific and intraspecific infections, since antibodies are produced against foreign A and B antigens that enter the body with pathogenic microflora. Mimicking pathogenic adhesive glycotopes with other glycans is another possible protective mechanism. While binding sites of infective agents to epithelium surface may support their colonization, ABO antigens secreted into biological fluids may serve as “bait” receptors for pathogenic microflora and thus have a protective function [4].

Despite evolutionary patterns, gastrointestinal diseases associated with *Helicobacter pylori* are the most susceptible in persons with “zero” blood type, that is confirmed in meta-analysis of Z. Chakrani et al. [10]. One of the reasons is the absence of glycosyl transferase enzyme, catalyzing attachment of terminal monosaccharides to L-fucose of substance H, a common precursor for antigens A and B. In 0(I) blood group carriers transformation of substance H into Le-b antigen is inherent. High level of this antigen in the stomach and duodenum mucous membrane increases susceptibility to *H.pylori* infection because it serves as an additional receptor for this microorganism [11].

For the majority of infectious diseases susceptibility of “antigenic” blood groups carriers is higher in comparison with carriers of “zero” group. In particular, meta-analysis by A. Degarege et al. [12], who studied peculiarities of malaria course depending on blood group affiliation, showed that persons with A(II), B(III) and AB(IV) blood groups have higher chances of developing *P. falciparum* malaria [13-16] infection. When comparing placental infection prevalence it was noted that in comparison with 0(I) blood group probability of active course of *P. falciparum* malaria is higher in women with “antigenic” blood groups [17-19]. According to R. E. Tiongco meta-analysis, who studied

## Non-communicable Diseases

Correlation between ABO system blood group affiliation and coronary heart disease risk development was established. According to Z. Chen et al. [21, 22], individuals with 0(I) blood group have the lowest risk, and individuals with A(II) blood group – the highest one.

Carbohydrate components of antigens A and B are expressed on platelet glycoprotein receptors - GP IIa and IIIa, as well as on GP IIb/IIIa complex, playing a key role in thrombosis process. GP IIb / IIIa receptor complex ensures platelet aggregation by binding fibrinogen, fibronectin and von Willebrandt factor. GP IIa, as part of GP Ia / IIa complex, binds platelets to collagen in damaged endothelium sites. Thus, ABO antigens are able to modify platelet glycoprotein receptors structure and play a certain role in thrombosis, that explains risk of cardiovascular diseases development [23].

It was found that the incidence of thromboembolic complications in various diseases is associated with blood group affiliation, incidence in “antigenic” blood groups is 30% higher compared to 0 (I) group carriers [24].

This interrelation can also be explained by antigen-mediated change of von Willebrandt factor levels and factor VIII in plasma [6], the lowest content of which is observed in “zero” blood group carriers.

Antigens A and B carriers have an elevated content of these factors, contributing to an increased risk of thrombosis, also explaining risk of myocardial ischemia. Difference in presented coagulation factors level is caused by the fact that some of von Willebrandt factor sites are subjected to structural modifications by means of ABO antigens. Three O-glycans are known to directly bind with antigenic determinants, leading to posttranslational changes in these molecules [25].

It is interesting to note that coagulation profile difference is reflected far beyond coagulation system. For example, correlation between von Willebrand factor and factor VIII levels and vascular dementia and cognitive impairment development was shown. 0 (I) blood group carriers are less susceptible to age-related cognitive changes and therefore have longer life expectancy. Another intriguing mechanism may include antiangiogenic properties of von Willebrand factor, explaining a more complete brain vascularization in individuals with group 0 (I), due to the lower content of von



Willebrand factors and factor VIII compared to individuals with blood group A(II), B(III) or AB(IV) [26].

In addition to relation between somatic diseases and blood group affiliation, there are also associations with mental disorders. According to S. Pisk et al. meta-analysis [27], mental disorders development in general is typical for AB(IV) blood group carriers. As for certain diseases, depressive disorders are more common in A(II) blood type carriers, and the risk of schizophrenia and bipolar affective disorder is higher in O(I) blood type carriers [28]. According to some studies, more frequent occurrence of bipolar affective disorder in individuals with O(I) blood group is associated with changes in dopamine- $\beta$ -hydroxylase enzyme activity, that is involved in dopamine- noradrenaline transformation, increased in bipolar affective disorder, and decreased in depression. O(I) blood group carriers are also more susceptible to schizophrenic disorders, probably due to excessive dopamine activity [29].

## Cancer

Stomach cancer ranks fifth among the most frequently diagnosed malignant tumors and is the third most important cause of death worldwide [30], so establishing relationship between blood group and this type of cancer is of great diagnostic importance. Currently, it has been determined that A(II) and AB(IV) blood groups have the largest number of patients with stomach cancer [31]. It follows that a certain role is played by antigen A, affecting systemic inflammatory reactions, intercellular adhesion, membrane signal transmission, as well as immune surveillance of malignant cells. It is assumed that persons positive for this antigen have lower free hydrochloric acid production, which plays the role of antibacterial protection, compared to those who do not carry this antigen [32]. Also, in A(II) and AB(IV) blood groups carriers there is a decrease in type 1 intercellular adhesion molecule soluble form production as compared to O(I) and B(III) blood groups, which negatively affects immune system antitumor protection [33]. The lowest risk of esophageal cancer is typical for persons with O(I) blood group, and the highest risk is in persons with B(III) blood group [34].

Over one million new cases of breast cancer are diagnosed annually [35]. According to S.Y. Miao et al. meta-analysis [36], the highest risk of breast cancer is observed in women with A (II) blood group. One of the reasons is the fact that normal breast tissue constantly expresses blood group antigens of the same type, while in the areas of benign neoplasia a more diverse pattern of antigen expression is observed. They play an important role in malignant progression and tumor cells spread [37].

## Oral Diseases

Inflammatory and destructive diseases of oral cavity are equally important in general morbidity structure. Differential secretion of blood group AB0 antigens in tissues may be a factor influencing development of oral cavity systemic diseases and depends on patient secretory status. AB0 system antigens expression is influenced by differentiation and maturation of cells in stratified squamous epithelium of oral cavity. Basal layer cells express precursors of carbohydrate chains of A and B antigens, while antigens themselves are more often found in spinous layer. In oral tissues A and B-glycosyltransferase and their substrates presence determines expression of A and B antigens [38].

Correlation of inflammatory-destructive diseases with blood group affiliation has not been yet established, obtained results are contradictory and there are no meta-analyses. We cite studies by a number of authors on this problem. According to G.P. Pai et al. [39], whose study included 750 individuals, the highest percentage of healthy volunteers was found among O(I) blood group carriers, while most patients with moderate to severe gingivitis were of blood group A(II) and B(III). A similar situation is observed in individuals who have been diagnosed with periodontitis. This pattern may be due to the fact that antigens A and B are receptors for fixation of infective agents, thereby contributing to periodontal disease development.

According to D. Mostafa et al. [40], whose study involved 1126 patients with generalized chronic periodontitis, in contrast, individuals with O(I) blood group are at increased risk regardless of severity compared to other blood groups. O(I) blood group carriers and persons of A(II), B(III), AB(IV), who do not have antigens A and B in their oral fluids, are more susceptible to inflammatory and destructive oral diseases. Low IgA in the oral fluid should also be considered, which may compromise their ability to maintain oral antibiotic protection [41].

## Conclusion

Considering blood groups as an evolutionary heritage, we can conclude that O (I) blood group carriers, whose erythrocyte membrane contains no AB0 antigens in comparison with other "antigenic" variants of this system, have a certain advantage in relation to general risk of neoplasm development, cardiovascular diseases, thromboembolic complications, and some other life-threatening infections.

Over the past decades, various researchers have assessed whether congenital biological determinant, that is AB0 antigens affiliation, has clinical significance beyond its use in transfusion and transplantation medicine.

Currently, there is sufficient data available to demonstrate the role of ABO antigens in various systemic diseases pathogenesis, including cancer, infectious, cardiovascular and a number of other diseases. The data presented justifies necessity to take into account blood group affiliation when diagnosing various diseases, planning treatment or assessing prognosis. It may be reasonable to include blood group affiliation into scales for determining risk of cardiovascular diseases, coagulation disorders, gastrointestinal diseases.

Determining ABO group affiliation has become a routine laboratory study, but prospect of using this data in context of personalized medicine is still underestimated.

### Conflict of Interest Statement

The study was not sponsored; the authors state that there is no conflict of interest.

### References

1. Yamamoto FI, McNeill PD, Komlato Y, Yamamoto M, Hakomori SI, Ishimoto S, et al. Molecular genetic analysis of the ABO blood group system: 2. Cis-AB alleles. *Vox Sana*. 1993;64(2):120–3. <https://doi.org/10.1111/j.1423-0410.1993.tb02529.x>
2. Yamamoto M, Tarasco MC, Cid E, Kobayashi H., Yamamoto F. ABO blood group A transferase and its codon 69 substitution enzymes synthesize FORS1 antigen of FORS blood group system. *Sci Rep*. 2019;9(1):9717. <https://doi.org/10.1038/s41598-019-46029-7>
3. Reid M, Lomas-Francis C. *The Blood Group Antigen Facts Book*. London: Elsevier; 2004. 758 p. <https://doi.org/10.1046/j.1365-3148.1998.00127.x>
4. Dotz V, Wuher M. Histo-blood group glycans in the context of personalized medicine. *Biochim Biophys Acta*. 2016;1860(8):1596–1607. <https://doi.org/10.1016/j.bbagen.2015.12.026>
5. Gil'mijarova FN, Radomskaja VM, Gergel' NI, Gusjakova OA, Sidorova IF. Blood groups: biological variability of the cell composition and metabolism in normal and pathological conditions. Moscow: Izvestija; 2007. Russian.
6. Gil'mijarova FN, Gusjakova OA, Kuz'micheva VI, Ereshhenko AA, Vasil'eva TV, Borodina IA, et al. Cellular composition and blood metabolic profile according to ABO system: grouping, comparative description. *Sib Med Rev*. 2019;3:24–33. Russian. <https://doi.org/10.20333/2500136-2019-3-24-33>
7. Gusjakova OA, Gil'mijarova FN, Kuz'micheva VI, Ereshhenko AA, Potjakina EE, Murskij SI, et al. Coagulation test features depending on the ABO-blood system antigenic composition. *Klin Lab Diagn*. 2019;64(3):170–5. Russian. <https://doi.org/10.18821/0869-2084-2019-64-3-170-175>
8. Gil'mijarova FN, Gergel' NI, Kosjakova Ju. ABO-group-specific features of red blood cells are normal and with hemophilia. *Gematolog Transfuziolog*. 2012;57(S3):102. Russian.
9. Kosjakova YuA, Davydkin IL, Gil'mijarova FN, Gergel' NI, Gusjakova OA, Seleznyova IA, et al. Group-specific hemopoietic potential in health individuals and hemophilia patients. *Gematolog Transfuziolog*. 2015;60(1):18–21. Russian.
10. Chakrani Z, Robinson K, Taye B. Association Between ABO Blood Groups and Helicobacter Pylori Infection: A Meta-Analysis. *Sci Rep*. 2018;8(1):17604. <https://doi.org/10.1038/s41598-018-36006-x>
11. Boren T, Falk P, Roth KA, Larson G, Normark S. Attachment of Helicobacter pylori to human gastric epithelium mediated by blood group antigens. *Science*. 1993;262(5141):1892–95. <https://doi.org/10.1126/science.8018146>
12. Degarege A, Gebrezgi MT, Beck-Sague CM, Wahlgren M, de Mattos LC, Madhivanan P. Effect of ABO Blood Group on Asymptomatic, Uncomplicated and Placental Plasmodium Falciparum Infection: Systematic Review and Meta-Analysis. *BMC Infect Dis*. 2019;19(1):86. <https://doi.org/10.1186/s12879-019-3730-z>
13. Gupte SC, Patel AG, Patel TG. Association of ABO groups in malaria infection of variable severity. *J Vector Borne Dis*. 2012;49(2):78–81.
14. Thakur A, Verma IC. Malaria and ABO blood groups. *Indian J Malariol*. 1992;29(4):241–4.
15. Zerihun T, Degarege A, Erko B. Association of ABO blood group and Plasmodium falciparum malaria in Dore Bafeno area, Southern Ethiopia. *Asian Pac J Trop Biomed*. 2011;1(4):289–94. [https://doi.org/10.1016/s2221-1691\(11\)60045-2](https://doi.org/10.1016/s2221-1691(11)60045-2)
16. Jeremiah ZA, Jeremiah TA, Emelike FO. Frequencies of some human genetic markers and their association with Plasmodium falciparum malaria in the Niger delta, Nigeria. *J Vector Borne Dis*. 2010;47(1):11–6.
17. Bedu-Addo G, Gai PP, Meese S, Eggelte TA, Thangaraj K, Mockenhaupt FP. Reduced prevalence of placental malaria in primiparae with blood group O. *Malar J*. 2014;13:289. <https://doi.org/10.1186/1475-2875-13-289>
18. Senga E, Loscertales MP, Makwakwa KE, Liomba GN, Dzamalala C, Kazembe PN, et al. ABO blood group phenotypes influence parity specific immunity to Plasmodium falciparum malaria in Malawian women. *Malar J*. 2007;6:102. <https://doi.org/10.1186/1475-2875-6-102>

19. Degarege A, Gebrezgi MT, Ibaneza G, Wahlgren M, Madhivanan P. Effect of the ABO blood group on susceptibility to severe malaria: a systematic review and meta-analysis. *Blood Rev.* 2018;33:53–62. <https://doi.org/10.1016/j.blre.2018.07.002>
20. Tiongco RE, Paragas NA, Dominguez MJ, Lasta SL, Pandac JK, Pineda-Cortel MR. ABO Blood Group Antigens May Be Associated With Increased Susceptibility to Schistosomiasis: A Systematic Review and Meta-Analysis. *J Helminthol.* 2018;94:e21. <https://doi.org/10.1017/S0022149X18001116>
21. Chen Z, Yang SH, Xu H, Li JJ. ABO Blood Group System and the Coronary Artery Disease: An Updated Systematic Review and Meta-Analysis. *Sci Rep.* 2016;6:23250. <https://doi.org/10.1038/srep23250>
22. Wazirali H, Ashfaq RA, Herzig JW. Association of blood group A with increased risk of coronary heart disease in the Pakistan population. *Pak J Physiol.* 2005;1(1-2).
23. Zhong M, Zhang H, Reilly JP, Christie JD, Ishihara M, Kumagai T, et al. ABO Blood Group as a Model for Platelet Glycan Modification in Arterial Thrombosis. *Arterioscler Thromb Vasc Biol.* 2015;35(7):1570–8.
24. Vasan SK, Rostgaard K, Majeed A, Ullum H, Titlestad KE, Pedersen OB, et al. ABO Blood Group and Risk of Thromboembolic and Arterial Disease: A Study of 1.5 Million Blood Donors. *Circulation.* 2016;133(15):1449–1457. <https://doi.org/10.1161/CIRCULATIONAHA.115.017563>
25. Jenkins PV, O'Donnell JS. ABO blood group determines plasma von Willebrand factor levels: a biologic function after all? *Transfusion.* 2006;46(10):1836–44. <https://doi.org/10.1111/j.1537-2995.2006.00975.x>
26. Franchini M, Liumbruno GM. ABO blood group and neurodegenerative disorders: more than a casual association. *Blood Transfus.* 2016;14(2):158–9. <https://doi.org/10.2450/2015.0169-15>
27. Pisk SV, Vuk T, Ivezić E, Jukić I, Bingulac-Popović J, Filipčić I. ABO Blood Groups and Psychiatric Disorders: A Croatian Study. *Blood Transfus.* 2019;17(1):66–71. <https://doi.org/10.2450/2018.0266-17>
28. Flemenbaum A, Larson JW. ABO-RH blood groups and psychiatric diagnosis: a critical review. *Dis Nerv Syst.* 1976;37(10):581–3.
29. Meijas-Aponte CA. Specificity and impact of adrenergic projections to the midbrain dopamine system. *Brain Res.* 2016;1641(Pt B):258–73. <https://doi.org/10.1016/j.brainres.2016.01.036>
30. Bray F, Ferlay J, Soerjomataram I, Siegel RL, Torre LA, Jemal A. Global cancer statistics 2018: GLOBOCAN estimates of incidence and mortality worldwide for 36 cancers in 185 countries. *CA Cancer J Clin.* 2018;68(6):394–424. <https://doi.org/10.3322/caac.21492>
31. Mao Y, Yang W, Qi Q, Yu F, Wang T, Zhang H, et al. Blood Groups A and AB Are Associated With Increased Gastric Cancer Risk: Evidence From a Large Genetic Study and Systematic Review. *BMC Cancer.* 2019;19(1):164. <https://doi.org/10.1186/s12885-019-5355-4>
32. Sievers M.L. Hereditary aspects of gastric secretory function; race and ABO blood groups in relationship to acid and pepsin production. *Am J Med.* 1959;27:246–55. [https://doi.org/10.1016/0002-9343\(59\)90345-6](https://doi.org/10.1016/0002-9343(59)90345-6)
33. Pare G, Chasman DI, Kellogg M, Zee RY, Rifai N, Badola S, et al. Novel association of ABO histo-blood group antigen with soluble ICAM-1: results of a genome-wide association study of 6,578 women. *PLoS Genet.* 2008;4(7):e1000118. <https://doi.org/10.1371/journal.pgen.1000118>
34. Wang W, Liu L, Wang Z, Lu X, Wei M, Lin T, et al. Population to Meta-Analysis. *Cancer Causes Control.* 2014;25(10):1369–77. <https://doi.org/10.1007/s10552-014-0442-y>
35. Ferlay J, Shin HR, Bray F, Forman D, Mathers C, Parkin DM. Estimates of worldwide burden of cancer in 2008: GLOBOCAN 2008. *Int J Cancer.* 2010;127(12):2893–917. <https://doi.org/10.1002/ijc.25516>
36. Miao SY, Zhou W, Chen L, Wang S, Liu XA. Influence of ABO Blood Group and Rhesus Factor on Breast Cancer Risk: A Meta-Analysis of 9665 Breast Cancer Patients and 244,768 Controls. *Asia Pac J Clin Oncol.* 2014;10(2):101–8. <https://doi.org/10.1111/ajco.12083>
37. Hakomori S. Antigen structure and genetic basis of histo-blood groups A, B and O: their changes associated with human cancer. *Biochim Biophys Acta.* 1999;1473:247–66. [https://doi.org/10.1016/s0304-4165\(99\)00183-x](https://doi.org/10.1016/s0304-4165(99)00183-x)
38. Campi C, Escovich L, Valdés V, Garcva Borrás S, Racca L, Racca A, et al. Secretor status and ABH antigens expression in patients with oral lesions. *Med Oral Patol Oral Cir Bucal.* 2007;12(6):E431–4.
39. Pai GP, Dayakar MM, Shaila M, Dayakar A. Correlation Between “ABO” Blood Group Phenotypes and Periodontal Disease: Prevalence in South Kanara District, Karnataka State, India. *J Indian Soc Periodontol.* 2012;16(4):519–523. <https://doi.org/10.4103/0972-124X.106892>
40. Mostafa D, Elkhatat EI, Koppolu P, Mahgoub M, Dhaifullah E, Hassan AH. Correlation of ABO Blood Groups and Rh Factor With The Severity of Generalized Chronic Periodontitis: Across Sectional Study in Riyadh, Saudi Arabia. *Open Access Maced J Med Sci.* 2019;7(4):617–22. <https://doi.org/10.3889/oamjms.2019.044>
41. Blackwell CC. The role of ABO blood groups and secretor status in host defences. *FEMS Microbiol Immunol.* 1989;1(6-7):341–9. <https://doi.org/10.1111/j.1574-6968.1989.tb02419.x>

# EFFICACY OF CURRENT METHODS FOR CORRECTION OF TALIPES EQUINOVARUS IN PATIENTS WITH CENTRAL HEMIPARESIS

V. Ondar<sup>1</sup>, A. Agaev<sup>1</sup>, S. Ismailova<sup>1</sup>, S. Prokopenko<sup>1</sup>, N. Isaeva<sup>1</sup>

<sup>1</sup>Prof. V.F. Voyno-Yasenetsky Krasnoyarsk State Medical University, Krasnoyarsk, Russian Federation

## Abstract

The problem of physiological gait stereotype restoration in patients with post-stroke central hemiparesis remains relevant to this day. This is primarily associated with high risk of falls in this category of patients. At this point, there is a wide variety of methods related to exercise treatment and robotised correction or restoration of impaired gait against the background of post-stroke hemiparesis. At the same time, the problem of management of talipes equinovarus associated with this syndrome remains quite complex and not completely solved. We have analysed existing methods of talipes equinovarus correction with different levels of evidentiality.

## Keywords

*talipes equinovarus • hemiparesis • risk of falls*

## Main Text

Both the problem of cerebrovascular accident (CA) and the process of rehabilitation after CA remain relevant in all states around the globe [1]. The objective of verticalization with subsequent gait restoration is top priority for post-CA patients with the syndrome of central hemiparesis. Each stage of recovery involves application of walkers, quad canes. Walking without support has a risk of falls. According to existing research, the risk of falls after stroke for the inpatient varies from 14% to 65% [2, 3].

After discharge, falls occurred in 73% of the cases [2]. Such high possibility of falls for central hemiparesis patients is determined by several factors. These are, firstly, reduction of muscle strength and loss of the capability of leaning on the paretic extremity. Oftentimes, patients develop incorrect centre-of-gravity shifting (CoG). In particular, the shift occurs in direction of the intact extremity. This makes the patient less stable and the risk of falls during gait increases. Also, of large importance in occurrence of falls in central hemiparesis patients is the formation of talipes equinovarus. At the current stage of neurorehabilitation technology development, there are different methods for correction of muscle strength deterioration and CoG shifting which in turn leads to decreased risk of falls during gait. However, methods that effectively correct talipes equinovarus are quite restricted and insufficient.

Let us investigate into the reasons determining this. Hypertonia occurs in the following muscles in equinovarus deformity: tibialis anterior, tibialis posterior, peroneus longus, soleus, gastrocnemius, extensor hallucis longus, flexor hallucis longus [4]. This changes gait biomechanics. Talipes equinovarus prevents natural maximum ankle-joint dorsiflexion at the third stage of the gait cycle, restricts foot lifting from the supporting surface at the beginning of the fourth stage [5]. Additionally, there is a decrease in the support surface area and compensatory knee-joint hyperextension [6].

Means and methods exerting influence on talipes equinovarus could be conveniently classified into methods removing the defect and methods correcting it. The methods completely removing talipes equinovarus are the following: proprioceptive correction suits, spasticity-decreasing methods, central muscle relaxants, biological feedback with electromyography, vibration therapy and percutaneous electric neurostimulation. The methods that only temporarily correct talipes equinovarus are orthoses.

Let us give a more detailed description of each method. The proprioceptive correction suit consists of supporting and load parts. This system works as a muscle support structure. Elements of the system are located in close approximation

to extensors, flexors and rotation muscles. Thus, it is possible to achieve reflective response of the organism to external stimulation. Analogical elements are located on the foot for correction of its positioning. The evidentiality level of this method is D [7, 8].

One of the options for paretic extremity spasticity decrease and thus elimination of talipes equinovarus is vibration treatment (Vibromatic, "Grizzly"). However, application of this method has a number of restrictions: epilepsy, common infectious diseases, third-degree cardiovascular insufficiency, severe angina, malignant tumours, thrombophlebitis, trophic ulcers, severe neuroses and significant endocrine system dysfunction. The average course of treatment totals 10 procedures [9, 10].

The method of EMG with biological feedback is recommended for correction of spasticity with the C-level central hemiparesis syndrome. The method implies the following: application of electrodes on active muscles leads to appearance of an electromyographic signal which is in accordance with the real activity of the muscle. Therefore, the patient and the attending physician may assess objectively real physical activity and the response of the muscle to the load [11].

Also, on the purpose of spasticity decrease and alleviation of the pain syndrome, the patients are recommended to undergo percutaneous electric neurostimulation. It evokes the "blockade" of the pain impulse, increase in local blood flow, decrease of the perineural oedema, destruction of algogenic substances (bradykinin) and inflammation mediators (acetylcholine, histamine). The method uses impulse current 2-400Hz with short impulse duration (20-50ms) [12, 13].

Application of physiotherapy as means reducing spasticity in the paretic foot is also relevant in the modern neurorehabilitation practice. These may include thermal procedures, as well as electric stimulation of certain muscle groups, e.g. tibialis anterior [14].

Therapeutic massage of paretic limbs exerts positive influence on decrease of the muscle tone. It is recommended to use light stroking of affected muscles. The antagonist muscles, oppositely, can be rubbed or massaged with superficial kneading in a faster pace [15].

Additionally, there are medical treatment methods for spasticity decrease in the paretic foot of patients with central hemiparesis syndrome. These include: local antispasmodic therapy using A-type botulinum toxin that leads to development of chemodenervation. A-type botulinum toxin affects neuromuscular transmission directly due to release of acetylcholine at the presynaptic level and further long-term muscle relaxation. This determines its antispasmodic action. Botulinum toxin injection must be performed directly into spasmodic muscles in an optimally selected dose, which provides for a positive and safe effect [16]. This method is

recommended for muscle tone lowering, increase of movement volume in the impaired extremity, contracture development prevention, gait improvement and pain alleviation in spastic patients [17, 18]. It is most effective to combine botulinum toxin therapy and rehabilitation methods [19]. This provides for improvements in gait pace acceleration, step length increase, static and dynamic balance improvement and, consequently, reduction of the risk of falls. Dosage: it is recommended to adhere to intervals of at least 12 weeks between injections in order to prevent development of resistance to the preparation. The evidentiality level for this method is A [20, 21].

Usage of central muscle relaxants is recommended for treatment of generalised spasticity that significantly restricts mobility and working capacity in patients with central hemiparesis [22]. Muscle-relaxing action is determined by affecting  $\alpha$ 2-adrenergic receptors located at the spinal cord level. Another possible mechanism is facilitation of inhibitive influence of GABA and decrease of neural transmission activity, which lowers motor cortex excitability [23]. However, action of central muscle relaxants is not targeted in relation to separate muscle groups. This may lead to the development of undesired general muscle weakness [24]. This type of therapy has the evidentiality level B. Foot orthoses are technical means of rehabilitation used for foot load alleviation, its fixation and correction of talipes equinovarus. Despite temporariness of their effect (for the duration of wearing), this means of correction has evidentiality level A. It is recommended in the setting of need for immediate improvement of gait quality and velocity or weight distribution in legs during standing and walking [4]. Usage of orthoses may be temporary during rehabilitation exercises or constant in order to eliminate the risk of falls during the patient's independent walking [25].

## Conclusion

It becomes obvious from studying accessible methods of talipes equinovarus correction for post-stroke patients with hemiparesis that there is no method that would eliminate the aforesaid defect completely. All described means and methods only partially solve the problem. Thus, the risk of falls remains high for this category of patients. As a consequence, search for a brand-new solution in correction of talipes equinovarus in the patient with central hemiparesis syndrome remains relevant.

## Conflict of Interest Statement

We declare that there is no conflict of interest that would be associated with this paper.



## References

1. Sakhpova AG. The use of carotid endarterectomy in the acute phase of ischemic stroke. *Izvestia RAS SamSC*. 2015;17(5-3):857–60. Russian.
2. Batchelor F, Hill K, Mackintosh S. What works in falls prevention after stroke?: a systematic review and meta-analysis. *Stroke*. 2010;41(8):1715–22. <https://doi.org/10.1161/STROKEAHA.109.570390>
3. Verheyden G, Weerdesteyn V, Pickering R, Kunkel D, Lennon S, Geurts A, et al. Interventions for preventing falls in people after stroke. *Cochrane Database Syst Rev*. 2013;5:CD008728. <https://doi.org/10.1002/14651858.CD008728.pub2>
4. Petrushanskaya KA, Gritsenko GP, Spivak BG, Sutchenkov IA. Biomechanical and physiological foundation of application of orthotics of the lower extremities in hemiparesis of the cerebral origin. *Russ J Biomech*. 2011;15(4):60–77. Russian.
5. Bernshtejn NA. On the construction of movement. Moscow: Medgiz; 1947. 255 p. Russian.
6. Belova AN, Prokopenko SV. *Neurorehabilitation*. Moscow; 2010. 1288 p. Russian.
7. Pollock A, Baer G, Pomeroy V. Physiotherapy treatment approaches for the recovery of postural control and lower limb function following stroke. *Cochrane Database Syst Rev*. 2007;24:CD001920. <https://doi.org/10.1002/14651858.CD001920.pub2>
8. Shvarkov SB, Titova EYu, Mizieva ZM, Matveeva OS, Bobrovskaya AN. Application of integrated proprioceptive correction in motor recovery in patients with stroke. *J Clin Pract*. 2011;3:3–8. Russian.
9. Suh HR, Han HC, Cho HY. Immediate therapeutic effect of interferential current therapy on spasticity, balance, and gait function in chronic stroke patients: a randomized control trial. *Clin Rehabil*. 2014;28(9): 885–91. <https://doi.org/10.1177/0269215514523798>
10. Murillo N, Valls-Sole J, Vidal J. Focal vibration in neurorehabilitation. *Eur J Phys Rehabil Med*. 2014; 50(2):231–42.
11. Ondar VS, Narodova VV, Lyapin AV. The application of biofeedback method in post-stroke patients with central hemiparesis syndrome with the object of recovering equilibrium and gait. *J New Med Technol*. 2011;3:260–4. Russian.
12. Suh HR, Han HC, Cho HY. Immediate therapeutic effect of interferential current therapy on spasticity, balance, and gait function in chronic stroke patients: a randomized control trial. *Clin Rehabil*. 2014;28(9):885–91. <https://doi.org/10.1177/0269215514523798>
13. Kostenko EV, Petrova LV, Eneeva MA. Functional electrical stimulation in complex rehabilitation of patients with post-stroke lower-limb spasticity. *Doctor.ru*. 2014;13(101):15–21. Russian.
14. Parfenov VA. Interdisciplinary problem of poststroke spasticity treatment. *Mod Rheumatol J*. 2008;2(2):85–8. Russian.
15. Parfenov VA. Management of post-stroke patients with spasticity. *Eff Pharmacother*. 2015;39:28–34. Russian.
16. Kostenko EV, Petrova LV. Post-stroke spasticity of the lower limb: a comprehensive rehabilitation of patients with the use of botulinum toxin (onabotulinumtoxin A). *Neurosci Behav Physiol*. 2014;10:39–48. Russian.
17. Fieztzek U, Kossmehl P, Schelosky L, Ebersbach G, Wissel J. Early botulinum toxin treatment for spastic pes equinovarus – a randomized double-blind placebo-controlled study. *Eur J Neurol*. 2014;21(8):1089–95. <https://doi.org/10.1111/ene.12381>
18. Tao W, Yan D, Li JH, Shi ZH. Gait improvement by low-dose botulinum toxin A injection treatment of the lower limbs in subacute stroke patients. *J Phys Ther Sci*. 2015;27(3):759–62. <https://doi.org/10.1589/jpts.27.759>
19. Krylova LV, Hasanova DR. Rehabilitation of patients with post-stroke spasticity of the lower limb at an early restorative period. *Med Coun*. 2017;17:82–90. Russian.
20. Pimentel LH, Alencar FJ Rodrigues LR, Sousa FC, Teles JB. Effects of botulinum toxin type A for spastic foot in post-stroke patients enrolled in a rehabilitation program. *Arq Neuropsiquiatr*. 2014;72(1):28–32. <https://doi.org/10.1590/0004-282X20130189>
21. Santamato A, Micello M, Ranieri M, Valeno G, Albano A, Baricich A, et al. Employment of higher doses of botulinum toxin type A to reduce spasticity after stroke. *J Neurol Sci*. 2015;350(1-2):1–6. <https://doi.org/10.1016/j.jns.2015.01.033>
22. Kamen LA, Henney HR, Runyan JD. Practical overview of tizanidine use for spasticity secondary to multiple sclerosis, stroke, and spinal cord injury. *Curr Med Res Opin*. 2008;24(2):425–39. <https://doi.org/10.1185/030079908X261113>
23. Parfenov VA. Treatment for poststroke spasticity, the use of mydocalm. *Neurol Neuropsychiatry Psychosom*. 2011;3:65–70. Russian.
24. Willerslev-Olsen M, Lundbye-Jensen J, Petersen T, Nielsen JB. The effect of baclofen and diazepam on motor skill acquisition. *Exp Brain Res*. 2011;213(4):465–74. <https://doi.org/10.1007/s00221-011-2798-5>
25. Mayo NE, MacKay-Lyons MJ, Scott SC, Moriello C, Brophy J. A randomized trial of two home-based exercise programmes to improve functional walking poststroke. *Clin Rehabil*. 2013;27(7):659–71. <https://doi.org/10.1177/0269215513476312>



# CADUCEUS OR ROD OF ASCLEPIUS? EXPLORING LOGOS OF UNIVERSITY TEACHING HOSPITALS IN NIGERIA

Kehinde Kazeem Kanmodi<sup>1,2</sup>, Ifeoluwa Oluwasolafunmi Ogidan<sup>3</sup>, Oluwatobi Emmanuel Adegbile<sup>4</sup>, Precious Ayomide Kanmodi<sup>1,5</sup>

<sup>1</sup>Cephas Health Research Initiative Inc, Ibadan, Nigeria

<sup>2</sup>Aminu Musa Habib College of Health Science and Technology, Yauri, Nigeria

<sup>3</sup>School of Nursing, Obafemi Awolowo University Teaching Hospital, Ile-Ife, Nigeria

<sup>4</sup>Department of Paediatrics, College of Medicine, University of Ibadan, Ibadan, Nigeria

<sup>5</sup>Department of Statistics, Federal University of Technology, Akure, Nigeria

## Abstract

**Background:** Historically, the Rod of Asclepius is considered as the correct symbol of Medicine. Unfortunately, many medical/health institutions in the world have erroneously interchanged the Rod of Asclepius symbol with erroneous symbols (e.g. Caduceus) to depict Medicine. This study aims to assess the official logos (i.e. institutional symbols) of university teaching hospitals in Nigeria and determine if these logos actually depict the true symbol of Medicine.

**Methods:** This study was a cross-sectional online survey of teaching hospitals in Nigeria on their official logos. A total of 40,556 operating hospitals and clinics in Nigeria were identified. After systematic screening, a total of 35 hospitals were identified as university teaching hospitals and used for the survey. Official information about the geopolitical zone, ownership and official logo of the selected hospitals was obtained (via online and offline search). Data collected was analysed using SPSS version 22 software.

**Results:** Out of the 35 surveyed university teaching hospitals, only 7 did not have snake(s) as part of their official logo. However, out of the remaining 28 hospitals that have snake(s) as part of their official logos, only 57.1% (16/28) of them have only one snake in their logo. Exactly half of the surveyed hospitals having logos with two entwined snakes (i.e. Caduceus) were owned by the federal government. Bivariate analysis showed that there exists statistically significant relationship between the geopolitical zone where a hospital is situated and the number of entwined snakes indicated in their official logo (p-value=0.034).

**Conclusion:** This study shows that the correct symbol of Medicine is not universally indicated in the official logos of the university teaching hospitals in Nigeria.

## Keywords

Logo • emblem • symbol • Rod of Asclepius • Caduceus • tertiary • hospitals • Nigeria

## Introduction

The significance of symbols in diverse spheres of life is very huge [1]. The Mariam Webster Dictionary defines symbols as “something that stands for or suggests something else by reason of relationship, association, convention, or accidental resemblance”. Symbols are crucial in establishing historical facts and cultural heritage. In the field of Medicine, symbols have found significant use in medical and health professions. One such is the symbol representing the medical profession, which is the symbol depicting an entwined snake and a staff – the Rod of Asclepius (Figure 1) [2-5].

The Rod of Asclepius is widely considered as the historically true symbol depicting Medicine [4]. However, there seems to be some variance in the recognition and the use of this medical symbol as symbols depicting two entwined snake

around a winged staff are sometimes used to depict Medicine in some arenas [6-10]. The symbol depicting two entwined snake around a winged staff is referred to as the Caduceus (Figure 2) [11-13].

Historically, Asclepius was a demigod, the son of god Apollo, who lived in the latter part of the 8th century BC, who heals people from their sicknesses [14-16]. By 500 BC, the acceptance of Asclepius as a demigod of healing was more established among physician-healers in Ancient Greece, making these physician-healers to be regarded as Asclepiads – the disciples of Asclepius [15]. Traditionally, in the 4th century BC, this demigod (Asclepius) is being depicted by “a bearded man wearing a robe that leaves his chest uncovered and holding a staff with his sacred single serpent coiled

around it" [15]. However, during the early 4th century AD, the worship of Asclepius and the use of Asclepius depictions were suppressed by the Roman Emperor Constantine due to the recognition of Christianity as the official religion of the Roman Empire; Greek was a colony of the Roman Empire during this historical period [15]. The suppression of Asclepius depictions persisted until the 16th and 17th centuries AD, when some European medical publishers adopted that the use of Rod of Asclepius symbol as a medical symbol [15].

On the other hand, the Caduceus is a symbol depicting the Caduceus of Hermes [15]. The Caduceus of Hermes is a magical wand [15]. Hermes was a god and the son of Zeus and Maia – Olympian gods [15]. Hermes is also a winged messenger god, a protector of merchants and thieves, a patron of travellers, and a conductor of the dead [15]. From the 7th century to the 17th century AD, Hermes was associated with alchemy, occultism, astrology, magic, and arts [15]. Hence, Hermes was historically considered as the patron of commerce [1, 15].

Based on the above, it is historically obvious that the Rod of Asclepius is the historically true symbol of modern Medicine that has been in existence for over two millennia [4, 15]. The Caduceus, often accepted as the current symbol of commerce, has often been deemed a misconception with its use as a medical symbol since the 19th century AD (over 200 years ago) [4, 15]. Medicine and Commerce are two different professional entities; hence there should not be inter-changeability errors in their use. A recent study conducted among medical students in a Nigerian university showed that the majority of the surveyed medical students were not aware of the historically appropriate medical symbol [1]. Also, some studies had recorded that some medical and health institutions/societies are using wrong medical symbols in their official logos; more importantly, none of these studies assessed the use of the true symbol of Medicine in medical and health institutions/societies in Nigeria [17, 18].

Hence, it becomes imperative to explore the medical symbols used in Nigerian university teaching hospitals and assess them to determine if they actually depict the historically true symbol of Medicine. Hence, we aim to conduct this study to assess the official logos (i.e. institutional symbols) of university teaching hospitals in Nigeria and determine if these logos actually depict the true symbol of Medicine.

## Methods

This study was a cross-sectional survey of university teaching hospitals in Nigeria on the official logos they use; this study was also conducted under strict compliance with the 1964 Helsinki Declaration.

In the study, we first identified the list and total number of operational hospitals and clinics in Nigeria ( $n=40,556$ ). Thereafter, we screened out all the non-tertiary care hospitals ( $n=40,300$ ) in Nigeria from the master list (we obtained this data online from the Nigeria Health Facility Registry [date of access: December 30, 2019]) [19].

Using the following criteria, we thereafter extracted the list of all functional university teaching hospitals to be included in the study from the list of tertiary care hospitals in the country:

- Approval of the university teaching hospital by the Medical and Dental Council of Nigeria for internship training [20];
- Status of the university teaching hospital as per training of medical students, as only those university teaching hospitals that are training medical students shall be included in the study.

Based on the above criteria, only 35 university teaching hospitals were selected for the study (Figure 3). After identifying these hospitals, an exploration of the official websites of these hospitals (see table 1 for the URLs) as well as the official and public documents (hard copies) was done. From these websites and documents, we obtained information on the ownership, and geographical locations (i.e. city and geo-political zone) of the surveyed hospitals. Also, from these sources, we examined their official logos for evaluation. The logo evaluation was based on the: (1) presence or absence of a snake in the logo; (2) the number of snakes in the logo, if available.

Collected data was computed into SPSS version 22 Software for analysis. Frequency distributions of all variables were determined. Also, Chi square test was used to test for associations between relevant variables, with a  $p$ -value of  $<0.05$  considered to be of statistical significance.

## Results

Only 35 university teaching hospitals were used for this study. These 35 hospitals are spread across the 6 geopolitical zones in Nigeria (South-West zone, South-East zone, South-South zone, North-East zone, North-West zone, and North-Central zone) (Table 2).

Out of these 35 surveyed hospitals, only 7 did not have snake(s) as part of their official logo. However, out of the remaining 28 hospitals that have snake(s) as part of their official logos, only 57.1% (16/28) of them have only one snake in the logo (Table 3). Exactly half of those surveyed hospitals having logos with two entwined snakes (i.e. Caduceus) were owned by the federal government, none of the surveyed hospitals in North-West geopolitical zone had a snake in their official logo, and all the surveyed hospitals in South-South and South-East geopolitical zones had at least

one snake included in their logo. Lastly, bivariate analysis showed that there exists statistically significant relationship between the geopolitical zone where a hospital is situated and the number of entwined snakes indicated in their official logo ( $p$ -value=0.034) (Table 3).

## Discussion

The issue of erroneous use of wrong medical symbols by medical institutions is not a new thing [21]. Even among medical practitioners and trainees, many of them are yet to know the correct symbol of Medicine [17, 18, 22, 23]. Historically, the correct medical symbol is the Rod of Asclepius [4, 5]. In a study surveying schools of health profession sciences in Canada, USA, and Puerto Rico, it was found that incorrect medical symbols were commonly used in their logos [17]. Also, in another similar survey solely conducted in the USA, it was revealed that 62% of health profession associations used the Caduceus symbol – a wrong medical symbol [18]. However, after extensive literature search, we found that no single published study had ever been conducted to assess the official medical symbols/logos used in Nigerian medical institutions. Due to this gap in knowledge, this scientific study was conducted to assess the use of the correct symbol of Medicine by Nigeria medical institutions, using university teaching hospitals as a case study. The rationale for selecting university teaching hospitals for this survey is because they are: tertiary institutions; in the highest level of medical care; and also the highest citadel of learning for medical practitioners in Nigeria. However, there are more than 35 teaching hospitals in Nigeria, but due to the scope of the study, as this study focuses on university teaching hospitals where medical students in Nigeria are trained; hence only these selected hospitals were included in this study.

It is also noteworthy that we did not conduct this study with the aim of belittling the institutions' choice of use of Caduceus symbol (although a wrong medical symbol [21, 24]) in their

logo, but rather to awaken the medical community to the use of the appropriate medical symbol and claim back a part of the beautiful heritage and legacy of medicine [23].

In this study, we recorded very interesting findings. We found that as high as 34.3% of the surveyed hospitals have Caduceus as part of their official institutional logo. As aforementioned, this issue of erroneous inter-changeability is a global phenomenon [1-14, 18, 19, 21-26]. We also found that these errors cut across all levels of ownership (i.e. private, state and federal) and geopolitical zones in Nigeria, with North-West zone being the only exemption.

Based on the aforementioned, it becomes imperative to re-awaken the medical community on the recognition and use of the historically correct symbol of medicine. This issue is of serious concern because new generations of medical professionals and trainees are emerging and they are predisposed to erroneously adopting the use of wrong medical symbols [1]. Based on the available studies, majority of health professionals and medical trainees lacked adequate knowledge on the historically correct medical symbol [17, 22]; hence the need for educational interventions as regards this issue.

However, this study has its limitations. This study surveyed university teaching hospitals in Nigeria only; hence, it will be difficult to make generalizations based on the existing data as hospitals in lower levels and in other countries were excluded in the study.

In conclusion, this study shows that the correct symbol of Medicine is not universally used by the university teaching hospitals in Nigeria. Hence, all the medical institutions in Nigeria using wrong medical symbol in their official logos need to take a look into this common error.

## Conflict of Interest Statement

This study was self-funded. The authors of this study have no conflict of interest to declare.

## References

1. Kanmodi KK, Adebayo O, Adesina MA, Fagbule OF, Emerenini F. One Snake or Two? Exploring medical symbols among medical students. *Acta Med Martiniana*. 2019;19(2):78–87. <https://doi.org/10.2478/acm-2019-0011>
2. Rakel RE. One snake or two? *JAMA*. 1985;253(16):2369. <https://doi.org/10.1001/jama.1985.03350400051020>
3. Retief FP, Cilliers L. Snake and staff symbolism, and healing. *S Afr Med J*. 2002;92(7):553–6.
4. Young P, Finn BC, Bruetman JE, Cesaro Gelos J, Trimarchi H. Rod of Asclepius. Symbol of medicine. *Rev Med Chil*. 2013;141(9):1197–201. <https://doi.org/10.4067/S0034-98872013000900013>

5. Medicine's logo. *Can Med Assoc J.* 1969;100(22):1064.
6. Adebayo O, Fagbule F, Oyabambi A. Caduceus or rod of Aesculapius: revisiting erroneous interchangeability. *Ann Ib Postgrad Med.* 2017;15(1):65–6.
7. Baird KA. The caduceus symbol. *Can Med Assoc J.* 1965;92(19):1038.
8. Sacks AC, Michels R. Images and Asclepius. Caduceus and Asclepius: History of an error. *Am J Psychiatry.* 2012;169(5):464. <https://doi.org/10.1176/appi.ajp.2012.11121800>
9. Wilcox RA, Whitham EM. The symbol of modern medicine: why one snake is more than two. *Ann Intern Med.* 2003;138(8):673–7. <https://doi.org/10.7326/0003-4819-138-8-200304150-00016>
10. Fromson JA. The Asclepius: The ancient standard of physicians. *Am J Psychiatry.* 2011;168(7):752. <https://doi.org/10.1176/appi.ajp.2011.11040539>
11. Capodicasa E. What symbol should represent the medical profession? *Lancet.* 2004;364(9432):416. [https://doi.org/10.1016/S0140-6736\(04\)16762-7](https://doi.org/10.1016/S0140-6736(04)16762-7)
12. Subbarayappa BV. The roots of ancient medicine: an historical outline. *J BioSci.* 2001;26(2):135–43. <https://doi.org/10.1007/bf02703637>
13. Hinek A, Backstein R. The magic wands of medicine [Internet]. *Univ Toronto Med J.* 2004 [cited 2020 Feb 02];82(1):68–70. Available from: <https://pdfs.semanticscholar.org/1785/76dcc63b29aa12e0076981d2ba400a6ea8d6.pdf>
14. Antoniou S, Antoniou G, Learney R, Granderath F, Antoniou A. The rod and the serpent: History's ultimate healing symbol. *World J Surg.* 2011;35(1):217–21. <https://doi.org/10.1007/s00268-010-0686-y>
15. Nayernouri T. Asclepius, Caduceus, and Simurgh as medical symbols, part I. *Arch Iran Med.* 2010;13(1):61–8.
16. Frazer RM. *The Poems of Hesiod.* Norman: University of Oklahoma Press; 1983. 150 p.
17. Hamann C, Martelon M. Branding Asklepios and the traditional and variant serpent symbol display among health professional schools in the United States, Puerto Rico, and Canada: A cross-sectional survey. *JMIR Med Educ.* 2016;2(1):e6. <https://doi.org/10.2196/mededu.5515>
18. Friedlander WJ. *The golden wand of Medicine: A history of the Caduceus symbol in Medicine.* New York: Greenwood Press; 1992. 295 p.
19. Federal Ministry of Health (Nigeria). National Health Facility Registry [Internet]. [cited 2020 Feb 01]. Available from: <https://hfr.health.gov.ng/>
20. Medical and Dental Council of Nigeria. Teaching hospitals approved by the Medical and Dental Council of Nigeria for internship training (with number of approved interns) [Internet]. [cited 2020 Feb 01]. Available from: [https://www.mdcn.gov.ng/public/storage/documents/document\\_812954199.pdf](https://www.mdcn.gov.ng/public/storage/documents/document_812954199.pdf)
21. Adebayo O. Symbols of Medicine. *History of Medicine: A glimpse, a work, and a world.* Ilorin: Insight & Project; 2006. 50 p.
22. Prakash M, Johnny JC. Things you don't learn in medical school: Caduceus. *J Pharm Bioallied Sci.* 2015;7(Suppl 1):S49–S50. <https://dx.doi.org/10.4103%2F0975-7406.155794>
23. Shetty A, Shetty S, Dsouza O. Medical Symbols in Practice: myths vs reality. *J Clin Diagn Res.* 2014;8(8):PC12–4. <https://doi.org/10.7860/JCDR/2014/10029.4730>
24. Kritikos A, Bekiari A, Famissis K, Nikitaras N, Sakellariou K. Asclepius. The “anax of trikki” as a symbol of sports education. *Stud Phys Cult Tour.* 2008;15(2):87–94.
25. Steensma DP. The symbol of modern medicine. *Ann Intern Med.* 2004;140(4):311–2. <https://doi.org/10.7326/0003-4819-140-4-200402170-00022>
26. Shin YJ. A history of Korean medical association's emblem: the caduceus of Asklepios and Hermes. *Uisahak.* 2017;16(1):21–35. Korean.

## Tables

**Table 1.** List of the surveyed university teaching hospitals and their websites

University Teaching Hospital	Website
<b>South-West Geo-political Zone</b>	
Lagos State University Teaching Hospital, Ikeja	<a href="https://www.lasuth.org.ng/">https://www.lasuth.org.ng/</a>
Lagos University Teaching Hospital, Idi-Araba	<a href="https://www.luth.org.ng/">https://www.luth.org.ng/</a>
Olabisi Onabanjo University Teaching Hospital, Sagamu	<a href="https://oouth.com/">https://oouth.com/</a>
Obafemi Awolowo University Teaching Hospitals Complex, Ile-Ife	<a href="https://oauthc.com/">https://oauthc.com/</a>
University College Hospital, Ibadan	<a href="http://uch-ibadan.org.ng/">http://uch-ibadan.org.ng/</a>
Ekiti State University Teaching Hospital, Ado-Ekiti	<a href="https://eksuth.org.ng/">https://eksuth.org.ng/</a>
Federal Teaching Hospital, Ido-Ekiti	<a href="https://fethi.gov.ng/">https://fethi.gov.ng/</a>
Babcock University Teaching Hospital,	<a href="https://www.babcock.edu.ng/buth">https://www.babcock.edu.ng/buth</a>
Ladoke Akintola University Teaching Hospital, Ogbomosho/Osogbo	<a href="http://www.lautechteachinghospital.org/">http://www.lautechteachinghospital.org/</a>
<b>South-East Geo-political Zone</b>	
Abia State University Teaching Hospital, Abia	Not available
Nnamdi Azikiwe University Teaching Hospital, Nnewi	<a href="https://nauth.org.ng/">https://nauth.org.ng/</a>
University of Nigeria Teaching Hospital, Enugu	<a href="http://www.unthenugu.com.ng/">http://www.unthenugu.com.ng/</a>
Imo State University Teaching Hospital, Orlu	Not available
Chukwuemeka Odumegwu Ojukwu University Teaching Hospital, Amaku	Not available
Madonna University Teaching Hospital, Elele	Not available
Alex Ekwueme Federal University Teaching Hospital, Abakaliki	<a href="http://www.aefutha.gov.ng/">http://www.aefutha.gov.ng/</a>
<b>South-South Geo-political Zone</b>	
University of Uyo Teaching Hospital, Uyo	<a href="https://www.uuthuyo.net/">https://www.uuthuyo.net/</a>
University of Calabar Teaching Hospital, Calabar	Not available
University of Benin Teaching Hospital, Benin	<a href="https://ubth.org/">https://ubth.org/</a>
University of Port Harcourt Teaching Hospital, Port Harcourt	<a href="https://upthng.com/">https://upthng.com/</a>
Delta State University Teaching Hospital, Oghara	<a href="https://delsuth.com.ng">https://delsuth.com.ng</a>
Niger Delta University Teaching Hospital, Okolobiri	<a href="https://www.nduth.org.ng">https://www.nduth.org.ng</a>
Igbinedion University Teaching Hospital, Okada	Not available
Rivers State University Teaching Hospital	<a href="https://www.rsuth.ng/">https://www.rsuth.ng/</a>
<b>North-East Geo-political Zone</b>	
University of Maiduguri Teaching Hospital, Maiduguri	<a href="https://www.umth.org.ng/">https://www.umth.org.ng/</a>
Federal Teaching Hospital, Gombe	<a href="https://fthg.ng/">https://fthg.ng/</a>
Abubakar Tafawa Balewa University Teaching Hospital, Bauchi	<a href="https://atbuth.org.ng/">https://atbuth.org.ng/</a>
<b>North-Central Geo-political Zone</b>	
University of Ilorin Teaching Hospital, Ilorin	<a href="http://uith.org/">http://uith.org/</a>
Jos University Teaching Hospital, Jos	<a href="http://www.juth.org.ng/">http://www.juth.org.ng/</a>
University of Abuja Teaching Hospital, Gwagwalada	<a href="https://uath.gov.ng/">https://uath.gov.ng/</a>
Benue State University Teaching Hospital, Markurdi	<a href="http://www.bsuth.org.ng/">http://www.bsuth.org.ng/</a>
Bingham University Teaching Hospital, Jos	<a href="http://www.bhuth.org.ng/">http://www.bhuth.org.ng/</a>
<b>North-West Geo-political Zone</b>	
Aminu Kano Teaching hospital, Kano	<a href="http://akth.org.ng/">http://akth.org.ng/</a>
Ahmadu Bello University Teaching Hospital, Zaria	<a href="http://abuth.gov.ng/">http://abuth.gov.ng/</a>
Usmanu Danfodiyo University Teaching Hospital, Sokoto	<a href="http://www.uduth.org.ng/">http://www.uduth.org.ng/</a>

**Table 2.** The surveyed university teaching hospitals in Nigeria

University Teaching Hospital	n	Ownership
<b>South-West Geo-political Zone</b>		
Lagos State University Teaching Hospital, Ikeja	0	State
Lagos University Teaching Hospital, Idi- Araba	1	Federal
Olabisi Onabanjo University Teaching Hospital, Sagamu	1	Federal
Obafemi Awolowo University Teaching Hospitals Complex, Ile-Ife	1	Federal
University College Hospital, Ibadan	0	Federal
Ekiti State University Teaching Hospital, Ado-Ekiti	2	State
Federal Teaching Hospital, Ido-Ekiti	2	Federal
Babcock University Teaching Hospital,	1	Private
Ladoke Akintola University Teaching Hospital, Ogbomosho/Osogbo	1	State
<b>South-East Geo-political Zone</b>		
Abia State University Teaching Hospital, Abia	2	State
Nnamdi Azikiwe University Teaching Hospital, Nnewi	2	Federal
University of Nigeria Teaching Hospital, Enugu	2	Federal
Imo State University Teaching Hospital, Orlu	2	State
Chukwuemeka Odumegwu Ojukwu University Teaching Hospital, Amaku	1	State
Madonna University Teaching Hospital, Elele	1	Federal
Alex Ekwueme Federal University Teaching Hospital, Abakaliki	1	Federal
<b>South-South Geo-political Zone</b>		
University of Uyo Teaching Hospital, Uyo	1	Federal
University of Calabar Teaching Hospital, Calabar	2	Federal
University of Benin Teaching Hospital, Benin	2	Federal
University of Port Harcourt Teaching Hospital, Port Harcourt	1	Federal
Delta State University Teaching Hospital, Oghara	2	State
Niger Delta University Teaching Hospital, Okolobiri	1	Federal
Igbinedion University Teaching Hospital, Okada	2	Private
Rivers State University Teaching Hospital	1	State
<b>North-East Geo-political Zone</b>		
University of Maiduguri Teaching Hospital, Maiduguri	1	Federal
Federal Teaching Hospital, Gombe	1	State
Abubakar Tafawa Balewa University Teaching Hospital, Bauchi	2	Federal
<b>North-Central Geo-political Zone</b>		
University of Ilorin Teaching Hospital, Ilorin	0	Federal
Jos University Teaching Hospital, Jos	1	Federal
University of Abuja Teaching Hospital, Gwagwalada	0	Federal
Benue State University Teaching Hospital, Markurdi	1	State
Bingham University Teaching Hospital, Jos	2	Private
<b>North-West Geo-political Zone</b>		
Aminu Kano Teaching hospital, Kano	0	Federal
Ahmadu Bello University Teaching Hospital, Zaria	0	Federal
Usmanu Danfodiyo University Teaching Hospital, Sokoto	0	Federal

"n" - Number of snakes represented on logo



**Table 3.** Comparison between medical logos and other variables

Variable		Number of snakes in official institutional logo			p-value
		One snake (n=16)	Two snakes (n=12)	No snake (n=7)	
Ownership	Federal	7 (43.6)	6 (50.0)	7 (100.0)	0.154
	State	6 (37.5)	4 (33.3)	0 (0.0)	
	Private	3 (18.8)	2 (16.7)	0 (0.0)	
Geopolitical zone	South-West	5 (31.3)	2 (16.7)	2 (28.6)	0.034
	South-East	3 (18.8)	4 (33.3)	0 (0.0)	
	South-South	4 (25.0)	4 (33.3)	0 (0.0)	
	North-East	2 (12.5)	1 (8.3)	0 (0.0)	
	North-Central	2 (12.5)	1 (8.3)	2 (28.6)	
	North-West	0 (0.0)	0 (0.0)	3 (42.9)	

*"n" – Total number of respondents per category*

## Figures

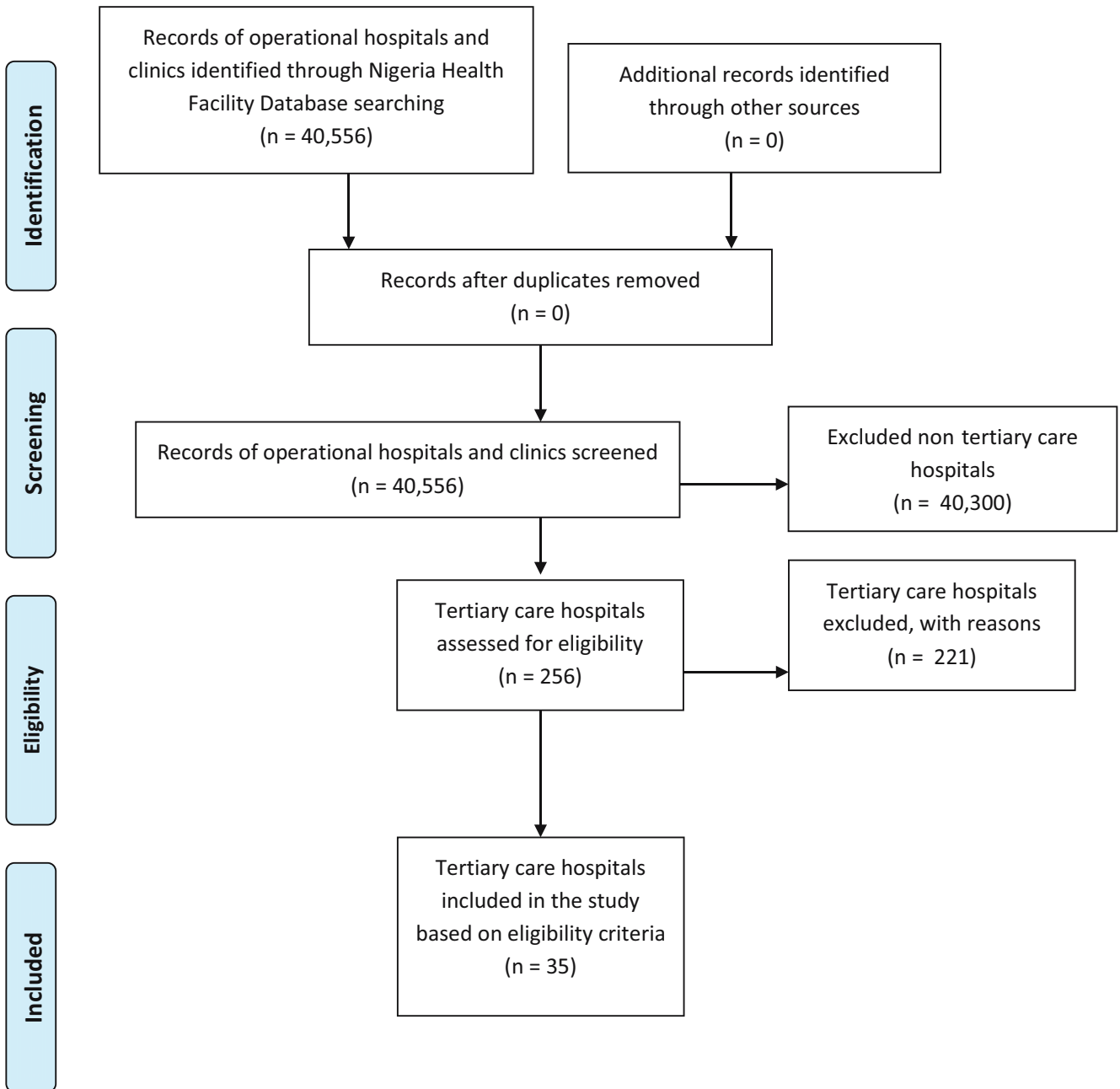
**Figure 1.** Rod of Asclepius (Source: [https://en.wikipedia.org/wiki/File:Esclapius\\_stick.svg](https://en.wikipedia.org/wiki/File:Esclapius_stick.svg) [Accessed on January 02, 2020])



**Figure 2.** Caduceus (Source: [https://commons.wikimedia.org/wiki/Caduceus#/media/File:Caduceus\\_large.jpg](https://commons.wikimedia.org/wiki/Caduceus#/media/File:Caduceus_large.jpg) [Accessed on January 02, 2020])



Figure 3. Diagram on data sorting



# SUCCESSFUL REPAIR OF COARCTATION OF THE AORTA AND OBSTRUCTIVE TOTAL ANOMALOUS PULMONARY VEINS CONNECTION IN A ONE-DAY-OLD NEWBORN

P.V. Teplov, A.Yu. Miller<sup>1</sup>, A.M. Titov<sup>1</sup>, V.A. Sakovich<sup>1</sup>

<sup>1</sup>Federal Center for Cardio-Vascular Surgery, Department of congenital heart disease, Krasnoyarsk, Russian Federation

## Abstract

A clinical case of successful repair of a combination of total anomalous pulmonary venous connection (TAPVC) with collector stenosis in one-day-old newborn. Only one case of successful correction of such a pathology is reported previously. The operation was performed with cardiopulmonary bypass and temporary antegrade brain perfusion. The narrowed aortic area was resected, the integrity of the aortic arch was restored using an extended anastomosis, and TAPVC correction was performed using a “sutureless technique”. The postoperative period was uneventful. The newborn was discharged from hospital on the 12th day.

## Keywords

newborn • coarctation of aorta • TAPVD

## Introduction

Coarctation of the aorta makes up 6–8% of all congenital heart defects and is defined as a narrowing of the aortic lumen, sometimes associated with important intracardiac lesions. Total anomalous pulmonary venous connection (TAPVC) is a rare pathology and occurs in about 0.4% to 2% of congenital heart defects. Combinations of these pathologies are very rare.

## Clinical Summary

The 2.9 kg newborn was admitted to the hospital on the first day of life in an extremely grave condition due to respiratory failure, coarctation of the aorta and supracardiac TAPVC with the proximal collector stenosis up to 65-70%. Flow velocity at the confluence of the superior vena cava to the right atrium up to 3 m/s, the calculated pulmonary artery systolic pressure was 70 mm Hg. Volume overload and dilatation of the right ventricle, and the compressed left ventricle were seen on transthoracic echocardiography (Fig.

1). Computed tomography performed shortly thereafter, clarified the anatomy of the echocardiographic findings (Fig. 2, Fig.3).

The presence of a wide patent ductus arteriosus and restrictive patent foramen ovale, contributed to hemodynamic instability. Despite that the child was on a constant prostaglandin E1 infusion, and cardiotoxic support, his condition was progressively worsening: arterial hypoxemia developed (SaO<sub>2</sub>-60%), also with combined arterial hypotension with systolic blood pressure of 30 mm Hg, and the pCO<sub>2</sub> increased up to 75 mm Hg.

An emergency operation was performed on the first day of life after the informed consent was obtained. We performed a median sternotomy, and moderately hypothermic cardiopulmonary bypass was established with ascending aorta and bicaval cannulations. After CPB initiating and cooling the patient's body to 28°C, aorta was clamped and antegrade blood cardioplegia was used for cardiac arrest. Afterwards the aortic cannula was advanced to the brachiocephalic trunk and fixed with a tourniquet, the left common carotid and subclavian arteries were clamped,

and brain perfusion was started. CPB flow reduced to 30% of initial flow of 200 ml/min/kg. Patent ductus arteriosus was ligated and divided. The descending aorta was clamped distal to the narrowing. A resection of the narrowed portion of the aorta was performed – extended anastomosis was formed with underneath of the aortic arch. Thereafter the aortic cannula was repositioned to the ascending aorta, and the clamps were removed from the carotid and subclavian arteries. The duration of selective brain perfusion was 23 min. Full flow CPB was continued and the patient was warmed up. Correction of the TAPVC was performed using the “sutureless” technique [1]: an anastomosis was formed between the left atrium appendage and the pulmonary veins collector with a continuous stitch. After aortic clamp was removed, cardiac activity was restored without any arrhythmias. Aortic clamping time was 49 min, CPB time (with selective brain perfusion) was 83 min. Modified ultrafiltration was used after cardiopulmonary bypass. The chest was closed primarily. Ultrasound episcan of the heart realized in the operating room showed the blood flow velocity through the pulmonary veins’ collector was less than 1 m/s, and the peak gradient did not exceed 10 mm Hg at the level of the proximal aortic anastomosis, right ventricular pressure reduced to 30 mm Hg. The postoperative period was uneventful, the time spent in the intensive care unit was three days. At the time of discharge, the condition of the patient after 12 days was regarded as satisfactory. 2 months after surgery, the patient has good heart function, heart failure is absent, there is no re-coarctation and he has a good outflow through the pulmonary veins.

## Conclusion

Acute heart failure, shock and acidosis often develop around 8–10 days of life in children with complex coarctation [2]. In an international population-based study evaluated with 422 cases, TAPVC and aortic coarctation co-existence was observed only in six (1.4%) cases. Only several cases were reported of repair combination of different types of anomalous pulmonary venous drainage and coarctation of the aorta in newborns and children [3-6]. De Leval et al. reported in 1973 a case of successful repair of a supracardiac non-obstructive total anomalous pulmonary venous drainage and preductal coarctation of the aorta in a 12-days old newborn [7]. We have presented the case of successful repair of combination of obstructive TAPVC and coarctation of the aorta of one-day-old newborn.

## Acknowledgements

We thank professor Vladimir Alexi-Meskhishvili, for assistance with this article. PVT, AYM, AMT and VAS contributed equally to this work.

## Conflict of Interest Statement

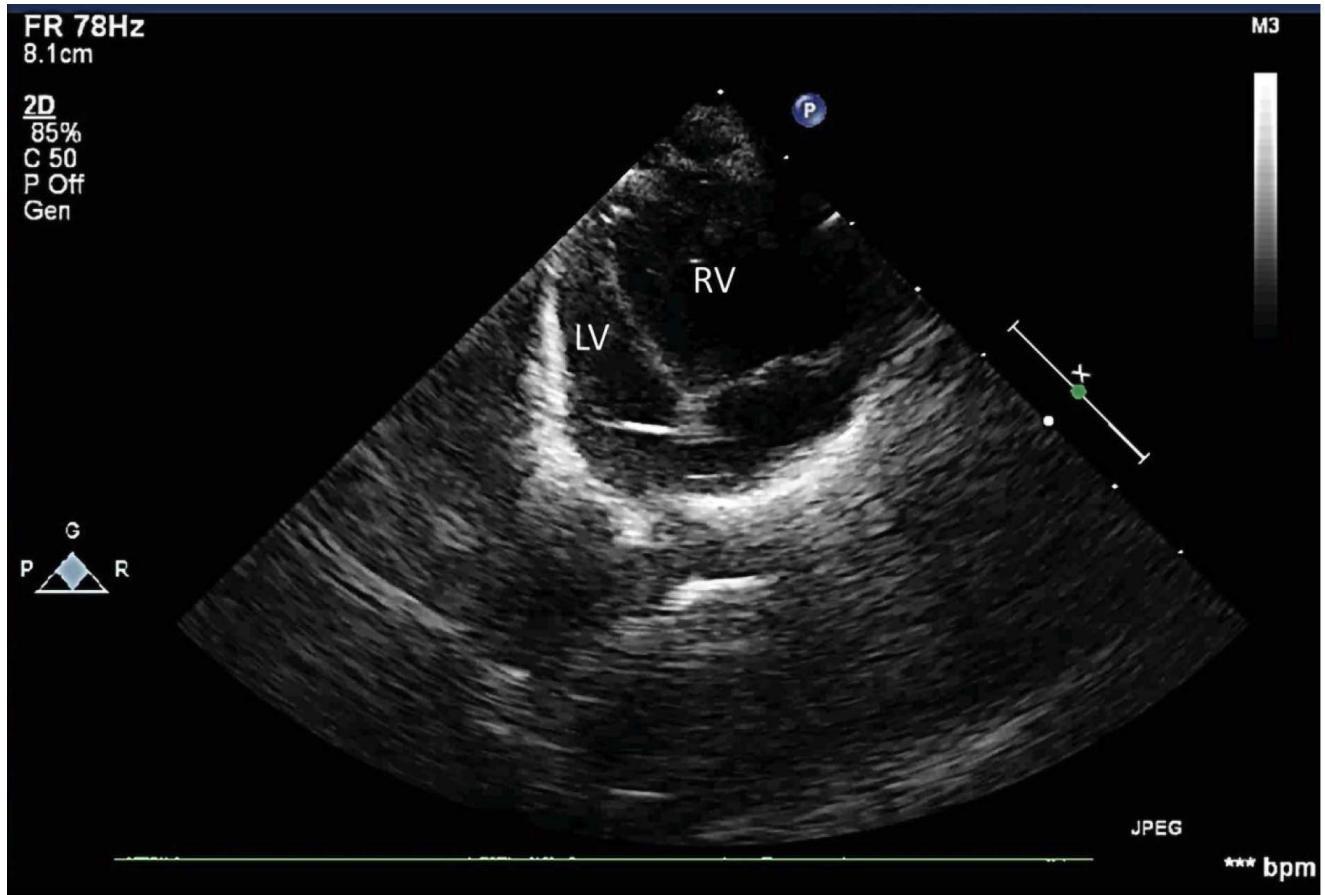
We have no conflict of interest to declare. Authors have nothing to disclose with regard to commercial support.

## References

1. Yanagawa B, Alghamdi AA, Dragulescu A, Viola N, Al-Radi OO, Mertens LL, et al. Primary sutureless repair for “simple” total anomalous pulmonary venous connection: Midterm results in a single institution. *J Thorac Cardiovasc Surg.* 2011;141(6):1346–54. <https://doi.org/10.1016/j.jtcvs.2010.10.056>
2. Lehnert A, Villemain O, Gaudin R, Méot M, Raisky O, Bonnet D. Risk factors of mortality and recoarctation after coarctation repair in infancy. *Interact Cardiovasc Thorac Surg.* 2019;29(3):469–75. <https://doi.org/10.1093/icvts/ivz117>
3. Ceylan Ö, Özgür S, Doğan V, Örün UA, Öcal B, Karademir S, et al. Supracardiac type total anomalous pulmonary venous return with obstruction, a rare combination: case report. *Türkiye Klinikleri Cardiovasc Sci.* 2012;24(1):79–82.
4. Doksöz Ö, Güven B, Demirpençe S, Özdemir R, Meşe T, Tavli V, et al. Coarctation of the aorta with infracardiac total anomalous pulmonary venous drainage: a rare combination. *Ann Thorac Cardiovasc Surg.* 2014;20 Suppl:778–80. <https://doi.org/10.5761/atcs.cr.13-00016>
5. Mei FY, Bai ZH, Hu ZB, Zhou H, Cui Y. Rare association of two cardiovascular malformations successfully corrected in a single surgery: a case report. *J Cardiothorac Surg.* 2017;12(1):58–60. <https://doi.org/10.1186/s13019-017-0619-z>
6. Khubulava GG, Naumov AB, Martchenko SP, Chupaeva OYu, Seliverstova AA, Aleksandrovitch YuS, et al. Blood gas analysis in newborns with low cardiac output syndrome after cardiac surgery. *The Bulletin of Bakoulev Center Cardiovascular Diseases.* 2018;19(5):676–87. Russian. <http://dx.doi.org/10.24022/1810-0694-2018-19-5-676-687>
7. de Leval MR, Stark J, Bonham-Carter RE. Total anomalous pulmonary venous drainage to superior vena cava associated with preductal coarctation of aorta. Successful correction in a 12-day-old infant. *Br Heart J.* 1973;35(10):1098–100. <http://dx.doi.org/10.1136/hrt.35.10.1098>

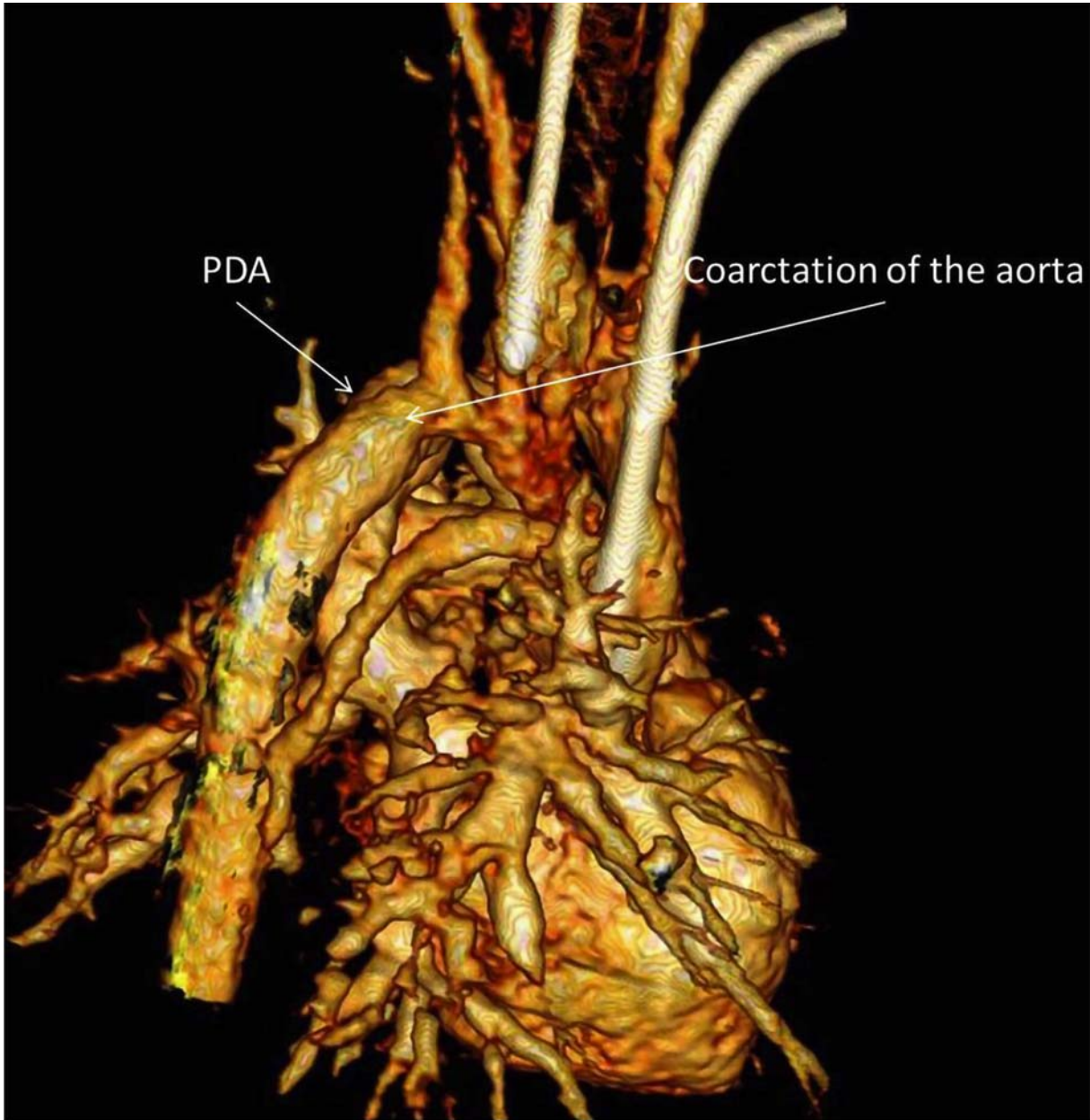
## Figures

**Figure 1.** TTE before surgery. Enlarged right ventricle (RV) compresses the left ventricle (LV). Right ventricular end diastolic size (RVEDS) is 11 mm, left ventricular end diastolic size (LVEDS) is 9.5 mm, indexed left ventricular diastolic volume (iLVEDV) is 5 ml/m<sup>2</sup>, left ventricular ejection fraction (EF LV) is 60%

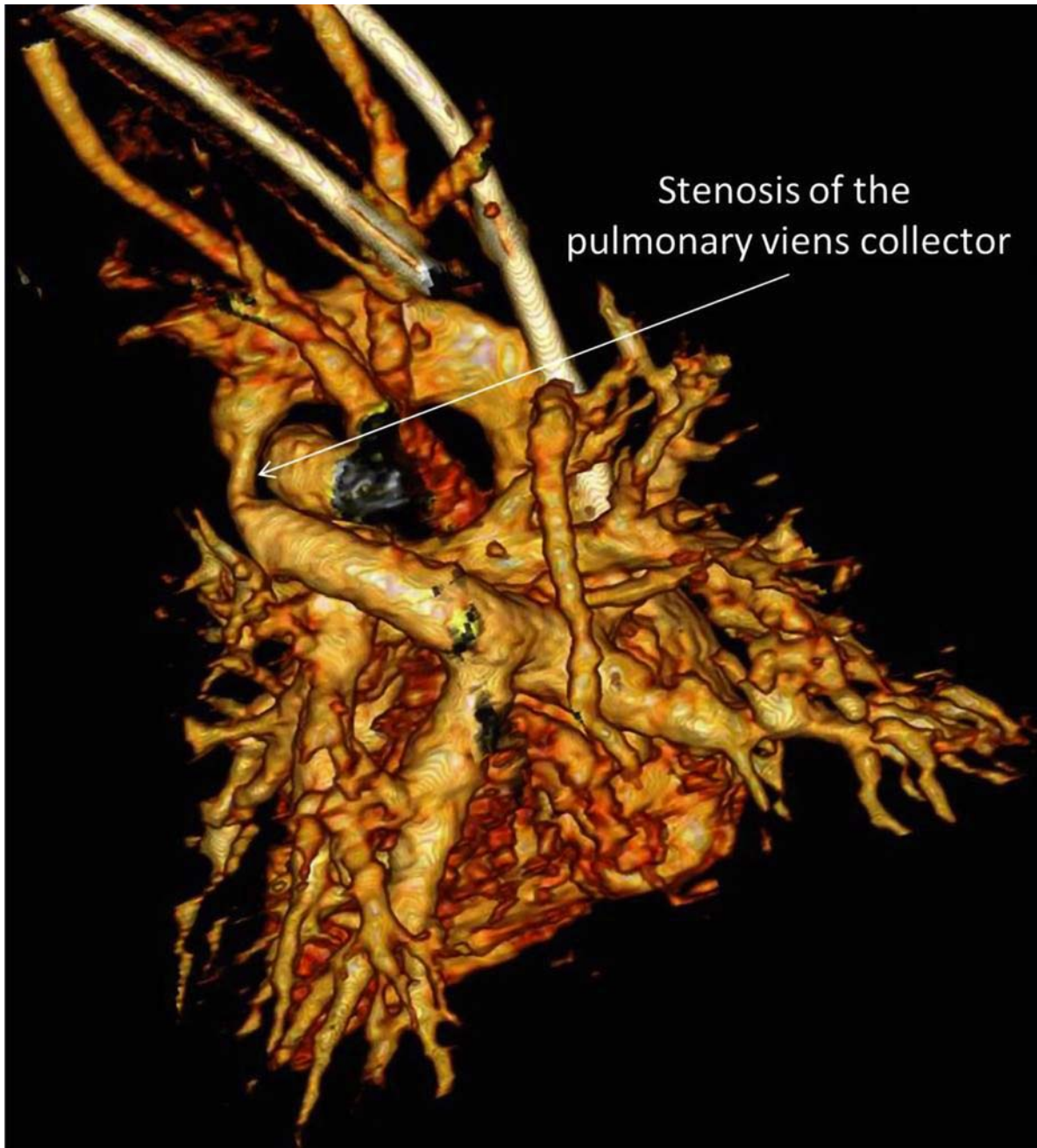




**Figure 2.** CT scan before surgery. Preductal coarctation of the aorta is marked by the arrow.



**Figure 3.** CT scan before surgery. Totally anomalous pulmonary veins connection in to the vertical vein. Collector stenosis marked by the arrow.



# CONCISE REVIEW: SARS-COV-2 PERSISTENCE IN THE ENVIRONMENT AND ITS SENSITIVITY TO BIOCIDES

E.B. Brusina<sup>1</sup>, E.A. Chezganova<sup>1</sup>

<sup>1</sup>Department of Epidemiology, Kemerovo State Medical University, Kemerovo, Russian Federation

## Abstract

The novel coronavirus SARS-CoV-2 has caused a global health threat. This review summarizes comprehensive research findings about the SARS-CoV-2 persistence in inanimate surfaces and opportunities for applying biocides to limit spread of COVID-19. SARS-CoV-2 is highly stable at 4°C but sensitive to heat and extremely stable in a wide range of pH values at room temperature. Coronaviruses also well survive in suspension. Desiccation has a more severe effect. SARS-CoV-2 can survive in the air for hours and on surfaces for days. Hospitals are significant epicenters for the human-to-human transmission of the SARS-CoV-2 for healthcare workers. The most contaminated SARS-CoV-2 zones and objects in isolation wards, in intensive care unit specialized for novel coronavirus pneumonia, are under discussion. SARS-CoV-2 is sensitive to standard disinfection methods. Studies revealed that 62-71% ethanol, 0.5% hydrogen peroxide or 0.1% sodium hypochlorite inactivated SARS-CoV-2 in 1 minute exposition; while 0.05-0.2% benzalkonium chloride or 0.02% chlorhexidine digluconate were less effective. Both ethanol and isopropanol were able to reduce viral titers after 30-seconds exposure. It was found for reusing personal protective equipment vaporized hydrogen peroxide treatment exhibits the best combination of rapid inactivation of SARS-CoV-2 and preservation of N95 respirator integrity under the experimental conditions. Overall, SARS-CoV-2 can be highly stable in a favourable environment, but it is also susceptible to standard disinfection methods. Environmental infection control of the air and especially for surfaces is considered as a mandatory step in addition to limiting person-to-person contact.

## Keywords

SARS-CoV-2 • persistence • inanimate surfaces • sensitivity • biocides

## Introduction

In the past two decades, the world has seen three coronaviruses epidemics that have caused a global health threat [1]. The novel coronavirus SARS-CoV-2 has infected more people than either of its two predecessors (SARS and MERS) and led to profound changes in many aspects of human life across the globe [2]. As of May 10, 2020, nearly four million COVID-19 cases in 187 countries with over 275,000 deaths worldwide were confirmed [3].

SARS-CoV-2 is an enveloped (65-125 nm), single-stranded, positive-sense RNA virus containing crown-like spikes on its envelope which is broadly distributed in humans and other mammals [4, 5]. SARS-CoV-2 has four main structural proteins including spike (S) glycoprotein, small envelope (E) glycoprotein, membrane (M) glycoprotein, and nucleocapsid (N) protein, and also several accessory proteins [6].

Exposure to SARS-CoV-2 occurs through direct and indirect contact with symptomatic and asymptomatic carriers who shed the virus. Transmission of coronaviruses from contaminated

dry surfaces has been postulated including self-inoculation through the conjunctiva, nasal or oral mucosa [7, 8]. The importance of coronavirus persistence on inanimate surfaces has been also emphasized by Geller and colleagues [9].

This review summarizes comprehensive research findings about the SARS-CoV-2 persistence in inanimate surfaces and opportunities for applying biocides to limit spread of COVID-19.

## Methods

PubMed and medRxiv databases have been screened for the terms “coronavirus” OR “COVID-19” OR “SARS-CoV-2” AND “surfaces” OR “fomites” OR “non-contact” AND “decontamination” OR “survival” OR “persistence”. The search resulted in 56 hits on PubMed and 324 hits on medRxiv. Overlapping or duplicate documents were removed to create

a benchmark dataset. This was used to determine if they were related to surface or fomite contamination as opposed to person-to-person contact spread. Ultimately, we ended up with 36 articles that provided information about search term and environmental contamination with a specific focus on surfaces. Currently, literature on the topic is growing rapidly, and the search results were dominated by publications on the medRxiv preprint server and as such it should be acknowledged that many of these are awaiting peer review.

## Results and Discussion

### **Survival under different conditions of humidity, temperature and UV radiation**

Survival rates of the human coronaviruses (HCoV) in the environment significantly depend on temperature, humidity, and pH. SARS-CoV2 is highly stable at 4°C but sensitive to heat. At 4°C, there was only around a 0.7 log-unit reduction of infectious titer on day 14, while at 22°C a 3-log unit reduction and complete elimination were detected after 7 and 14 days, respectively. At 37°C, a 3-log unit reduction was observed as soon as after 1 day and no virus was detected afterwards. When the incubation temperature was increased to 56°C and 70°C, the time for virus inactivation was reduced to 30 minutes and 5 minutes, respectively [10]. At 20°C, aerosolised HCoV-229E was found to better survive at 50% relative humidity than at 30% [11]. HCoV are more stable at slightly acidic pH (6-6.5) than at alkaline pH [12], in contrast SARS-CoV-2 is extremely stable in a wide range of pH values at room temperature (3- 10)

[10]. Currently, no studies have investigated the effects of UV radiation on SARS-CoV-2. However, SARS-CoV-2 is sensitive to oxygen, and UV can alter the structure of spike (S) protein and viral genome potentially leading to its inactivation [13].

### **Survival in biological fluids and aerosols**

SARS-CoV survive for at least 96 hours in sputum, serum and feces, yet its infectivity level is lower in urine [11]. Indeed, SARS-CoV did not survive beyond 24 hours in adult feces or beyond 3 hours in newborns' feces which is slightly acidic. In contrast, it could survive longer (up to 4 days) in diarrheic feces where pH can reach 9. The same study revealed a SARS-CoV survival until 4 to 5 days in respiratory specimens [14]. Surprisingly, SARS-CoV-2 has a longer half-life than influenza virus, SARS-CoV, monkeypox virus, and Mycobacterium tuberculosis [15; personal communication with Chad Roy].

### **Suspension and desiccation stability**

Coronaviruses also well survive in suspension. At 37°C, HCoV-229E and OC43 displayed survival rates of 80% and 100%, respectively, in phosphate buffered saline over 3 days and of 30% and 55%, respectively, over 6 days. Desiccation has a more severe effect on coronaviruses. HCoV-229E infectivity came down to 30% after 3 hours of desiccation on various surfaces, such as aluminum, sterile sponges, or surgical latex gloves [16].

### **Persistence of coronaviruses on inanimate surfaces**

Kampf group reported that SARS and Middle East Respiratory Syndrome (MERS) coronavirus or endemic human coronaviruses can persist on surfaces like metal, glass or plastic for up to 9 days (Table 1) [17].

**Table 1.** Persistence of coronaviruses on different types of inanimate surfaces (according to Kampf et al. [17]).

Type of surface	Virus	Strain / isolate	Inoculum (viral titer)	Temperature	Persistence	Reference
Steel	HCoV	229E	10 <sup>3</sup>	21°C	5 d	[18]
Aluminium	HCoV	229E and OC43	5 x 10 <sup>3</sup>	21°C	2–8 h	[19]
Metal	SARS-CoV	P9	10 <sup>5</sup>	RT	5 d	[11]
Wood	SARS-CoV	P9	10 <sup>5</sup>	RT	4 d	[11]
Paper	SARS-CoV	P9	10 <sup>5</sup>	RT	4–5 d	[11]
Glass	HCoV	229E	10 <sup>3</sup>	21°C	5 d	[18]
Plastic	HCoV	229E	10 <sup>7</sup>	RT	2–6 d	[20]
PVC	HCoV	229E	10 <sup>3</sup>	21°C	5 d	[18]
Silicon rubber	HCoV	229E	10 <sup>3</sup>	21°C	5 d	[18]
Surgical glove (latex)	HCoV	229E and OC43	5 x 10 <sup>3</sup>	21°C	≤ 8 h	[19]
Disposable gown	SARS-CoV	GVU6109	10 <sup>6</sup> / 10 <sup>5</sup> / 10 <sup>4</sup>	RT	2 d / 24 h / 1 h	[14]
Ceramic	HCoV	229E	10 <sup>3</sup>	21°C	5 d	[18]
Teflon	HCoV	229E	10 <sup>3</sup>	21°C	5 d	[18]

HCoV – human coronavirus; SARS – Severe Acute Respiratory Syndrome; RT – room temperature.



SARS-CoV-2 was more stable on plastic and stainless steel than on copper and cardboard, and viable virus was detected up to 72 hours after being applied to these surfaces, although the virus titer was greatly reduced. On copper, no viable SARS-CoV-2 was measured after 4 hours. Therefore, aerosol and fomite transmission is plausible and SARS-CoV-2 can survive in the air for hours and on surfaces for days reminiscent of the SARS-CoV decay curve. For either virus, there was exponential decay over time with survival depending on the amount of inoculum shed [21].

SARS-CoV-2 was more stable on smooth surfaces. No infectious virus could be detected from treated smooth surfaces on day 4 (glass and banknote) or day 7 (stainless steel and plastic). Strikingly, a detectable level of infectious virus could still be present on the outer layer of a surgical mask on day 7 (~0.1% of the original inoculum) [10].

### Viral shedding into the local environment

A study of 150 samples collected in the nurse station with suspected patients demonstrated positive rates of 3.57% (1/28) and 0.77% (1/130) in the air and on the surfaces, respectively [22].

The impact of viral shedding into the local environment (air and surfaces) was also evaluated during the isolation of patients with confirmed COVID-19, with 76.5% of all personal items (cell phones, tablets, reading glasses, computers, remote TV controls, exercise equipment, potters, nasal canula, spirometer, and the rim and seat of the toilet) from quarantine rooms tested positive. Typical room surfaces that were positive for SARS-CoV-2 included the windowsill, bedside tables, bed rails, and floors under the patient's bed [23].

Testing for SARS-CoV-2 from a variety of surfaces in cabins of symptomatic and asymptomatic Diamond Princess passengers recovered RNA for up to 17 days after the cabins were vacated, but before disinfection [24].

Hospitals are significant epicenters for the human-to-human transmission of the SARS-CoV-2 for healthcare workers. The most contaminated SARS-CoV-2 zones were the intensive care unit specialized for novel coronavirus pneumonia (NCP) (31.9%), obstetric isolation ward for pregnant women with NCP (28.1%), and isolation ward for NCP (19.6%). The most contaminated objects were self-service printers (20.0%), desktop/keyboard (16.8%), and doorknob (16.0%). Both hand sanitizer dispensers (20.3%) and gloves (15.4%) were most contaminated. These findings emphasize the urgent need to ensure adequate environmental cleaning, strengthen infection prevention

training, and improve infection prevention precautions among the healthcare workers during the outbreak of COVID-19 [25].

### Coronavirus in water environments

SARS-CoV-2 is a respiratory pathogen and its primary transmission mode is person-to-person contact through: 1) droplets generated by breathing, sneezing, coughing, and 2) direct contact with an infected subject or indirect contact through the hand-mediated transfer of the virus from contaminated fomites to the mouth, nose, or eyes. Studies have documented fragments of viral RNA in feces or anal swabs of infected patients [26, 27]. Transmission of COVID-19 through the fecal-oral route, however, has not been demonstrated but SARS-CoV-2 was detected in municipal wastewaters worldwide, specifically, in the Netherlands [28], Massachusetts [29], Australia [30], France [31], and Italy [32].

To summarize, the evidence of SARS-CoV-2 presence in waters are currently scarce and there is no evidence that HCoV and SARS-CoV2 are present in surface or groundwater sources or transmitted through contaminated drinking water. Environmental factors, such as temperature, seem to affect the ability of CoV to persist in water. Further studies are needed to investigate CoV persistence in water in relation to climatic and seasonal conditions. The evidence-based knowledge can provide a key support for the risk analysis in natural water resources and integrated water cycle as well as for the management and control of water-related risks during the pandemic COVID-19 caused by SARS-CoV2 [33].

### Sensitivity to standard disinfection methods

Virus inactivation was achieved within 1 minute using 62-71% ethanol, 0.5% hydrogen peroxide or 0.1% sodium hypochlorite; while 0.05-0.2% benzalkonium chloride or 0.02% chlorhexidine digluconate were less effective [17]. SARS-CoV-2 was highly susceptible to the WHO formulation I, based on 85% ethanol, which efficiently inactivated the virus with reduction factors of  $\leq 5.9$  and concentrations between 40-80%. WHO formulation II, which is based on 75% isopropanol, demonstrated a better virucidal effect at low concentrations, with complete viral inactivation and reduction factors of  $\leq 5$  at a minimal concentration of 30%. Both ethanol and isopropanol were able to reduce viral titers after 30-seconds exposure to background levels with reduction factors between  $\leq 4.8$  and

5.9. A concentration of 30% ethanol or isopropanol is also sufficient for viral inactivation [34].

The unprecedented pandemic of COVID-19 has created worldwide shortages of personal protective equipment, in particular respiratory protection such as N95 respirators [35]. In general, N95 respirators are designed for single use prior to disposal. Four different decontamination methods – UV radiation (260-285 nm), 70°C dry heat, 70% ethanol and vaporized hydrogen peroxide – were analyzed for their ability to reduce contamination with SARS-CoV-2 and their effects on N95 respirator function. Of these, vaporized hydrogen peroxide treatment exhibits the best combination of rapid inactivation of SARS-CoV-2 and preservation of N95 respirator integrity under the experimental conditions. UV radiation inactivates SARS-CoV-2 slower, yet preserving respirator function. 70°C dry heat inactivates SARS-CoV-2 with similar speed to UV and is likely to maintain acceptable fit scores for two rounds of decontamination. Ethanol decontamination is not recommended due to a loss of N95 integrity, confirming earlier findings [36].

## Conclusion

Overall, SARS-CoV-2 can be highly stable in a favourable environment, but it is also susceptible to standard disinfection methods. Environmental infection control of the air and especially for surfaces is considered as a mandatory step in addition to limiting person-to-person contact.

## Conflict of Interest Statement

None declared.

## Funding

There was no funding for this project.

## References

- Guarner J. Three Emerging Coronaviruses in Two Decades The Story of SARS, MERS, and Now COVID-19. *Am J Clin Pathol.* 2020;153(4):420–21. <https://doi.org/10.1093/ajcp/aqaa029>
- Čivljak R, Markotić A, Kuzman I. The third coronavirus epidemic in the third millennium: what's next? *Croat Med J.* 2020;61(1):1–4. <https://doi.org/10.3325/cmj.2020.61.1>
- World Health Organization. WHO Coronavirus Disease (COVID-19) Dashboard [Internet]. World Health Organization; 2020. [cited 2020 May 21]. Available from: <https://covid19.who.int>
- Huang C, Wang Y, Li X, Ren L, Zhao J, Hu Y, et al. Clinical features of patients infected with 2019 novel coronavirus in Wuhan, China. *Lancet.* 2020;395:497–506. [https://doi.org/10.1016/S0140-6736\(20\)30183-5](https://doi.org/10.1016/S0140-6736(20)30183-5)
- Ul Qamar MT, Alqahtani SM, Alamri MA, Chen LL. Structural basis of SARS-CoV-2 3CLpro and anti-COVID-19 drug discovery from medicinal plants. *J Pharm Anal.* 2020. <https://doi.org/10.1016/j.jpha.2020.03.009>
- Jiang S, Hillyer C, Du L. Neutralizing Antibodies against SARS-CoV-2 and Other Human Coronaviruses. *Trends Immunol.* 2020;41(5):355–59. <https://doi.org/10.1016/j.it.2020.03.007>
- Otter JA, Donskey C, Yezli S, Douthwaite S, Goldenberg SD, Weber DJ. Transmission of SARS and MERS coronaviruses and influenza virus in healthcare settings: the possible role of dry surface contamination. *J Hosp Infect.* 2016;92(3):235–50. <https://doi.org/10.1016/j.jhin.2015.08.027>
- Dowell SF, Simmerman JM, Erdman DD, Wu JS, Chaovavanich A, Javadi M, et al. Severe acute respiratory syndrome coronavirus on hospital surfaces. *Clin Infect Dis.* 2004;39(5):652–57. <https://doi.org/10.1086/422652>
- Geller C, Varbanov M, Duval RE. Human coronaviruses: insights into environmental resistance and its influence on the development of new antiseptic strategies. *Viruses.* 2012;4(11):3044–68. <https://doi.org/10.3390/v4113044>
- Chin A, Chu J, Perera M, Hui K, Yen H-L, Chanet M, et al. Stability of SARS-CoV-2 in different environmental conditions [posted 2020 Mar 27]. *medRxiv.* 2020:2020.03.15.20036673. <https://doi.org/10.1101/2020.03.15.20036673>
- Duan SM, Zhao XS, Wen RF, Huang JJ, Pi GH, Zhang SX, et al. Stability of SARS coronavirus in human specimens and environment and its sensitivity to heating and UV irradiation. *Biomed Environ Sci.* 2003;16(3):246–55.
- Lamarre A, Talbot PJ. Effect of pH and temperature on the infectivity of human coronavirus 229E. *Can J Microbiol.* 1989;35(10):972–4. <https://doi.org/10.1139/m89-160>
- Shirbandi K, Barghandan S, Mobinfar O, Rahim F. Inactivation of Coronavirus with Ultraviolet Irradiation: What? How? Why? [posted 2020 Apr 10]. *SSRN.* 2020. <http://dx.doi.org/10.2139/ssrn.3571418>
- Lai MY, Cheng PK, Lim WW. Survival of severe acute respiratory syndrome coronavirus. *Clin Infect Dis.* 2005;41(7):e67–71. <https://doi.org/10.1086/433186>



15. National Academies of Sciences, Engineering, and Medicine. Rapid Expert Consultation on SARS-CoV-2 Survival in Relation to Temperature and Humidity and Potential for Seasonality for the COVID-19 Pandemic (April 7, 2020). Washington, DC: The National Academies Press; 2020. <https://doi.org/10.17226/25771>
16. Sizun J, Yu MW, Talbot PJ. Survival of human coronaviruses 229E and OC43 in suspension and after drying on surfaces: a possible source of hospital-acquired infections. *J Hosp Infect.* 2000;46(1):55–60. <https://doi.org/10.1053/jhin.2000.0795>
17. Kampf G, Todt D, Pfaender S, Steinmann E. Persistence of coronaviruses on inanimate surfaces and their inactivation with biocidal agents. *J Hosp Infect.* 2020;104(3):246–51. <https://doi.org/10.1016/j.jhin.2020.01.022>
18. Warnes SL, Little ZR, Keevil CW. Human Coronavirus 229E Remains Infectious on Common Touch Surface Materials. *mBio.* 2015;6(6):e01697–15. <https://doi.org/10.1128/mBio.01697-15>
19. Sizun J, Yu MW, Talbot PJ. Survival of human coronaviruses 229E and OC43 in suspension and after drying on surfaces: a possible source of hospital-acquired infections. *J Hosp Infect.* 2000;46:55–60. <https://doi.org/10.1053/jhin.2000.0795>
20. Rabenau HF, Cinatl J, Morgenstern B, Bauer G, Preiser W, Dörr HW. Stability and inactivation of SARS coronavirus. *Med Microbiol Immunol.* 2005;194:1–6. <https://doi.org/10.1007/s00430-004-0219-0>
21. van Doremalen N, Bushmaker T, Morris DH, Holbrook MG, Gamble A, Williamson BN, et al. Aerosol and Surface Stability of SARS-CoV-2 as Compared with SARS-CoV-1. *N Engl J Med.* 2020;382(16):1564–67. <https://doi.org/10.1056/NEJMc2004973>
22. Jiang Y, Wang H, Chen Y, He J, Chen L, Liu Y, et al. Clinical Data on Hospital Environmental Hygiene Monitoring and Medical Staff Protection during the Coronavirus Disease 2019 Outbreak [posted 2020 Mar 02]. *medRxiv.* 2020:2020.02.25.20028043. <https://doi.org/10.1101/2020.02.25.20028043>
23. Santarpia JL, Rivera DN, Herrera V, Morwitzer MJ, Creager H, Santarpia GW, et al. Transmission Potential of SARS-CoV-2 in Viral Shedding Observed at the University of Nebraska Medical Center [posted 2020 Mar 26]. *medRxiv.* 2020:2020.03.23.20039446. <https://doi.org/10.1101/2020.03.23.20039446>
24. Moriarty LF, Plucinski MM, Marston BJ, Kurbatova EV, Knust B, Murray EL, et al. Public Health Responses to COVID-19 Outbreaks on Cruise Ships — Worldwide, February–March 2020. *MMWR Morb Mortal Wkly Rep.* 2020;69(12):347–52. <https://doi.org/10.15585/mmwr.mm6912e3>
25. Ye G, Lin H, Chen L, Wang S, Zeng Z, Wang W, et al. Environmental contamination of the SARS-CoV-2 in healthcare premises: An urgent call for protection for healthcare workers [posted 2020 Mar 16]. *medRxiv.* 2020:2020.03.11.20034546. <https://doi.org/10.1101/2020.03.11.20034546>
26. Holshue ML, DeBolt C, Lindquist S, Lofy KH, Wiesman J, Bruce H, et al. First Case of 2019 Novel Coronavirus in the United States. *N Engl J Med.* 2020;382(10):929–36. <https://doi.org/10.1056/NEJMoa2001191>
27. Xiao F, Tang M, Zheng X, Liu Y, Li X, Shan H. Evidence for Gastrointestinal Infection of SARS-CoV-2. *Gastroenterology.* 2020;158(6):1831–1833.e3. <https://doi.org/10.1053/j.gastro.2020.02.055>
28. Medema G, Heijnen L, Elsinga G, Italiaander R, Brouwer A. Presence of SARS-Coronavirus-2 in sewage [posted 2020 Mar 30]. *medRxiv.* 2020:2020.03.29.20045880. <https://doi.org/10.1101/2020.03.29.20045880>
29. Wu F, Xiao A, Zhang J, Gu X, Lee WL, Kauffman K, et al. SARS-CoV-2 titers in wastewater are higher than expected from clinically confirmed cases [posted 2020 Apr 07]. *medRxiv.* 2020:2020.04.05.20051540. <https://doi.org/10.1101/2020.04.05.20051540>
30. Ahmed W, Angel N, Edson J, Bibby K, Bivins A, O'Brien JW, et al. First confirmed detection of SARS-CoV-2 in untreated wastewater in Australia: A proof of concept for the wastewater surveillance of COVID-19 in the community. *Sci Total Environ.* 2020;728:138764. <https://doi.org/10.1016/j.scitotenv.2020.138764>
31. Wurtzer S, Marechal V, Mouchel JM, Maday Y, Teyssou R, Richard E, et al. Evaluation of lockdown impact on SARS-CoV-2 dynamics through viral genome quantification in Paris wastewaters [posted 2020 May 06]. *medRxiv.* 2020. <https://doi.org/10.1101/2020.04.12.20062679>
32. La Rosa G, Iaconelli M, Mancini P, Ferraro GB, Veneri C, Bonadonna L, et al. First detection of SARS-CoV-2 in untreated wastewaters in Italy [posted 2020 May 07]. *medRxiv.* 2020:2020.04.25.20079830. <https://doi.org/10.1101/2020.04.25.20079830>
33. La Rosa G, Bonadonna L, Lucentini L, Kenmoe S, Sufredini E. Coronavirus in water environments: Occurrence, persistence and concentration methods - A scoping review. *Water Res.* 2020;179:115899. <https://doi.org/10.1016/j.watres.2020.115899>
34. Kratzel A, Todt D, V'kovski P, Steiner S, Gultom ML, Thao TTN, et al. Efficient inactivation of SARS-CoV-2 by WHO-recommended hand rub formulations and alcohols [posted 2020 Mar 17]. *bioRxiv.* 2020:2020.03.10.986711. <https://doi.org/10.1101/2020.03.10.986711>
35. Ranney ML, Griffeth V, Jha AK. Critical Supply Shortages - The Need for Ventilators and Personal Protective Equipment during the Covid-19 Pandemic. *N Engl J Med.* 2020;382(18):e41. <https://doi.org/10.1056/NEJMp2006141>
36. Fischer RJ, Morris DH, van Doremalen N, Sarchette S, Matson MJ, Bushmaker T, et al. Assessment of N95 respirator decontamination and re-use for SARS-CoV-2 [posted 2020 Apr 24]. *medRxiv.* 2020:2020.04.11.20062018. <https://doi.org/10.1101/2020.04.11.20062018>

# EARLY PARKINSON'S DISEASE-LIKE PATHOLOGY IN A TRANSGENIC MOUSE MODEL INVOLVES A DECREASED CST3 MRNA EXPRESSION BUT NOT NEUROINFLAMMATORY RESPONSE IN THE BRAIN

T.A. Korolenko<sup>1</sup>, A.B. Shintyapina<sup>3</sup>, V.M. Belichenko<sup>1</sup>, A.B. Pupyshev<sup>1</sup>, A.A. Akopyan<sup>1</sup>, L.A. Fedoseeva<sup>1,4</sup>, G.S. Russkikh<sup>5</sup>, V.A. Vavilin<sup>3</sup>, M.V. Tenditnik<sup>1</sup>, C.-L. Lin<sup>6</sup>, T.G. Amstislavskaya<sup>2</sup>, M.A. Tikhonova<sup>1</sup>

<sup>1</sup>Laboratory of Experimental Models of Neurodegenerative Processes, Department of Experimental Neuroscience, Scientific Research Institute of Physiology and Basic Medicine, Novosibirsk, Russia

<sup>2</sup>Laboratory of Translational Biopsychiatry, Department of Experimental Neuroscience, Scientific Research Institute of Physiology and Basic Medicine, Novosibirsk, Russia;

<sup>3</sup>Laboratory of Drug Metabolism and Pharmacokinetics, Scientific Research Institute of Molecular Biology and Biophysics, Federal Research Center for Basic and Translational Medicine, Novosibirsk, Russia

<sup>4</sup>Laboratory of Evolutionary Genetics, Federal Research Center "Institute of Cytology and Genetics", Siberian Branch of the Russian Academy of Sciences, Novosibirsk, Russia

<sup>5</sup>Scientific Research Institute of Biochemistry, Federal Research Center for Basic and Translational Medicine, Novosibirsk, Russia

<sup>6</sup>Institute of Medicine, Chung Shan Medical University, Taichung, Taiwan

## Abstract

Pathological aggregation and accumulation of  $\alpha$ -synuclein in neurons play a core role in Parkinson's disease (PD) while its overexpression is a common PD model. Autophagy-lysosomal pathways are general intraneural mechanisms of protein clearance. Earlier a suppressed autophagy in the brain of young transgenic mice overexpressing the A53T-mutant human  $\alpha$ -synuclein (mut(PD)) was revealed. Previous studies have recognized that Cystatin C displays protective activity against neurodegeneration. This cysteine protease inhibitor attracts particular attention as a potential target for PD treatment related to autophagy modulation. Here we evaluated the mRNA levels of *Cst3* encoding Cystatin C in different brain structures of 5 m.o. mut(PD) mice at standard conditions and after the chronic treatment with a neuroprotective agent, ceftriaxone (100 mg/kg, 36 days). The inflammatory markers, namely, microglial activation by IBA1 expression and mRNA levels of two chitinases genes (*Chit1*, *Chia1*), were also assessed but no significant difference was found between control and transgenic mice. *Cst3* mRNA levels were significantly reduced in the striatum and amygdala in the transgenic PD model. Furthermore, this was associated with autophagy decline and might be added to early signs of synucleinopathy development. We first demonstrated the modulation of mRNA levels of *Cst3* and autophagy marker *Becn1* in the brain by ceftriaxone treatment. Taken together, the results support the potential of autophagy modulation through Cystatin C at early stages of PD-like pathology.

## Keywords

## Introduction

Pathological aggregation and accumulation of  $\alpha$ -synuclein appear to play a core role in the pathogenesis of Parkinson's disease (PD) [1] and overexpression of  $\alpha$ -synuclein is a common PD model [2]. Autophagy-lysosomal pathways, degradation and recycling of proteins by the ubiquitin/proteasome system are the main components of the cellular protein control system and general intraneural mechanisms of protein clearance [3] that are disturbed in PD [4]. A deeper understanding of the mechanisms that may lead to autophagy defects in PD is

required to develop the new therapeutic interventions. Cystatin C (Cst3) attracts particular attention as a potential therapeutic target for treatment of neurodegenerative disorders.

Cst3 is a cysteine protease inhibitor that possesses a broad spectrum of biological roles [5, 6]. Human or mouse brain tissue and cerebrospinal fluid contain the highest Cst3 concentration compared to other organs and tissues [7, 8]. Cst3 is implicated in neuroprotection and repair in the nervous system in response to diverse neurotoxic conditions

and neurodegeneration [9, 10]. Changes in the expression and secretion of Cst3 in the brain have been observed in the models of Alzheimer's disease, amyotrophic lateral sclerosis, as well as in the clinical bio-samples of patients with those neurodegenerative disorders [11]. However, few studies have explored the role of Cst3 in PD. In humans, elevated serum Cst3 was associated with cognitive disturbances and progression of PD [12], while in experimental studies, Cst3 prevented degeneration of dopaminergic neurons [13, 14]. Cst3 was suggested to play a protective role in neuronal challenge by inducing autophagy [15]. Hence, here we evaluated the mRNA levels of Cst3 encoding Cst3 and the levels of markers related to autophagy induction and regulation in different brain structures of young adult transgenic mice with overexpression of A53T-mutant  $\alpha$ -synuclein at standard conditions and after the chronic treatment with a neuroprotective agent, ceftriaxone (CEF). The emerging evidence supports the potential effect of CEF to alleviate the symptoms of different experimentally induced neurological disorders including PD [16, 17]. Recently we revealed its inhibitory effect on the augmented autophagy level in the brain of  $A\beta$ -induced mouse model of Alzheimer's disease [8], while its effects in PD models with the decreased basal levels of autophagy in the brain and possible involvement of Cst3 were not clear.

Microglial activation is generally considered as a consequence of neurodegeneration. However, some recent reports indicate that an inflammatory reaction because of the over-activation of microglia is an important factor of the neurodegeneration progression in PD [1, 18] and suggest a set of inflammatory biomarkers for PD diagnostics [19]. Here we also evaluated the contribution of this mechanism by the expression levels of inflammatory markers in the brain.

## Materials and Methods

### Animals and procedures.

Five-month-old male mice of B6.Cg-Tg(Prnp-SNCA<sup>A53T</sup>)23Mkle/J (further – mut(PD)) and control WT strain were purchased from the SPF-vivarium of the Institute of Cytology and Genetics SB RAS (Novosibirsk, Russia). Mut(PD) hemizygous mice were produced by the insertion of human A53T missense mutant form of alpha-synuclein cDNA in the mouse genome downstream of a mouse prion Prnp promoter ( <https://www.jax.org/strain/006823> ). All mice were housed in groups of 5-6 per cage (40 x 25 x 15 cm) under standard conditions (temperature: 18-22°C, relative humidity: 50-60%, 14/10 h light/dark cycle (lights off at 15-00)) with food and sterile water *ad libitum*.

In the experiment with the CEF treatment, mice were subdivided into four groups (5–6 animals each): 1) WT mice were treated

with the intraperitoneal (i.p.) injections of saline (0.9% NaCl solution, 100  $\mu$ l/10 g) for 36 days (WT+Saline); 2) WT mice were treated with the i.p. injections of CEF (100 mg/kg/day for 36 days) (WT+CEF); 3) mut(PD) mice were treated with the i.p. injections of saline for 36 days (Mut(PD)+Saline); 4) mut(PD) mice were treated with the i.p. injections of CEF for 36 days (Mut(PD)+CEF). In the present study we applied the dose of 100 mg/kg/day and treatment course of 36 daily drug injections of CEF that appeared to be effective for correction of both behavioral and neuronal deficits as well as for the modulation of the expression of genes in the brain of a genetic model of Alzheimer's disease (rats of OXYS strain) [20, 21].

Mice were sacrificed by decapitation. Immediately after sacrifice, brain structures (frontal cortex, hippocampus, amygdala, hypothalamus, and striatum) were rapidly dissected on ice, put in RNAlater solution (Invitrogen, USA) with following storage of the samples at -20°C until the total RNA extraction. For immunohistochemical analysis (IHC), separate cohorts of transgenic or WT mice (5–6 animals each) were used. IHC analysis of the expression of the autophagy marker LC3-II protein was preceded by the administration of chloroquine (16 h prior to euthanasia, 30 mg/kg, i.p.) [22]. On the day of euthanasia, mice were anesthetized with CO<sub>2</sub>. The animals were perfused transcardially with phosphate-buffered saline (PBS) followed by 4% paraformaldehyde in PBS, then the brains were rapidly excised and postfixed in PBS containing 30% sucrose at 4 °C until further neuromorphological analysis. All experimental procedures were performed according to the NIH Guide for the Care and Use of Laboratory Animals and approved by the Local Ethical Committee of the Institute. All efforts were made to minimize the number of animals used and their suffering.

### Quantitative real-time PCR (qPCR).

The relative amount of target mRNA was measured by qPCR according to previously published protocol with minor modifications [20]. Extraction of total RNA from the brain samples was performed using the Purelink RNA Mini Kit (Ambion, USA) according to the manufacturer's instructions for fresh-frozen tissue. Synthesis of cDNA was performed in the volume of 25  $\mu$ l from initial 1  $\mu$ g RNA using the Reverse Transcription System kit (Promega, USA) according to the manufacturer's instructions. Sequences of specific primers (Biosynthesis Ltd., Russia) for the reference genes (*Actb*, *Gapdh*, *Rpl13a*, *Ppia*) and target genes (*Cst3*, *Becn1*, *Chit1*, *Chia1*) were designed using the Primer 3 (NCBI) (Table 1); exon spanning primer sets including large introns were used to eliminate the detection of residual genomic DNA. qPCR was performed in a CFX96 Real-Time PCR Detection System (Bio-Rad, USA) and LightCycler 480 II (Roche, Switzerland) using HS-qPCR Mix SYBR Green (2x) (Biolabmix, Russia). All samples were analyzed in triplicate. PCR efficiency,

slope, correlation coefficient (R2) were calculated using CFX Manager™ 3.0 Software. Fold-change values were determined using the  $\Delta\Delta C_t$  relative quantification method. For *Becn1*, the quantitative analysis was performed according to Ruijter et al. (2009) [23] to calculate the starting concentration (N0) of each cDNA template. Levels of the target genes were normalized to the geometric average of the reference gene mRNA levels.

### **IHC analysis.**

The IHC analysis was performed on 30- $\mu$ m-thick cryosections according to a protocol described in detail previously [24]. Coronal slices along the frontal cortex (AP: 2.93 – 2.45 mm), striatum (AP: 0.49–0.37 mm), or hippocampus / amygdala / hypothalamus (AP: –2.03 to –2.15 mm) of each mouse brain were made. We applied a rabbit polyclonal antibody (NB100-2220, 1:400 dilution, Novus Biologicals, USA) as a primary antibody to detect autophagosome marker MAP1LC3B or a goat polyclonal antibody (NB100-1028, 1:200 dilution, Novus Biologicals, USA) as the primary antibody to detect microglial marker AIF-1/IBA1. A fluorescently labeled (Alexa Fluor 488–conjugated) goat anti-rabbit IgG antibody (ab150077, 1:600 dilution, Abcam, UK) or Alexa Fluor 488–conjugated donkey anti-goat IgG antibody (ab150129, 1:200 dilution, Abcam, UK) served as the secondary antibodies, respectively. Fluorescent images were finally obtained by means of an Axioplan 2 (Carl Zeiss) imaging microscope and then analyzed in Image Pro Plus Software 6.0 (Media Cybernetics, CA, USA). Fluorescence intensity (IBA1 expression) was measured as background-corrected optical density (OD with subtraction of staining signals of the non-immunoreactive regions) in the images converted to grayscale. Fluorescence intensity of punctate LC3 immunostaining was measured with subtraction of low diffuse fluorescence of some areas (punctate staining vs. background staining of the non-punctate regions) in the images converted to gray-scale. The area of interest was 18 192  $\mu$ m<sup>2</sup> in the striatum, amygdala, or the 3rd layer of the frontal cortex; 103 893  $\mu$ m<sup>2</sup> in the hypothalamus; 26 077  $\mu$ m<sup>2</sup> in the hippocampal CA1 or CA3 areas.

### **ELISA.**

Cst3 levels in serum and urine of mice were measured by specific sandwich Cystatin C Mouse ELISA kits (BioVendor, Czech Republic) using STAT FAX 2100 reader (Awareness Technology, USA) according to the manufacturer's instructions.

### **Statistics.**

All results were expressed as the mean  $\pm$  SEM. Statistical processing of data was performed using Student's t-test and two-way ANOVA followed by post-hoc Fisher LSD test, or nonparametric Mann-Whitney U-test and Kruskal–Wallis ANOVA followed by multiple comparisons of mean ranks for all groups (in case of the lack of normal distribution of the data

in the studied groups). The independent variables for two-way ANOVA were Genotype (WT or mut(PD) strain) and Treatment (Saline or CEF). STATISTICA 10.0 software was used to perform all the statistical analyses.

## **Results**

### **Analysis of mRNA levels of the target genes (*Becn1*, *Cst3*, *Chit1*, and *Chia1*) in the brain of a transgenic mouse PD model.**

In transgenic mice, *Becn1* expression was substantially decreased in the frontal cortex (Figure 1). *Cst3* gene expression analysis in the brain of mice with transgenic PD model revealed a statistically significant decrease in the striatum and amygdala vs. control WT mice (Figure 2A). Both *Chit1* and *Chia1* were expressed at low but detectable levels in the mouse brain areas studied (Figure 2B, C). There was no difference in the expression of both chitinases genes studied vs. control WT mice.

### **IHC analysis of LC3-II and IBA1 levels in the brain of a transgenic mouse PD model.**

In transgenic mice, the expression of an autophagy marker LC3-II was significantly decreased in the striatum, amygdala, and hypothalamus (Figure 3). The levels of LC3-II in the frontal cortex or hippocampus were not changed in mut(PD) mice. Transgenic mice had a reduced expression of microglial marker IBA1 in the striatum and frontal cortex but this parameter was markedly augmented in the hypothalamus of transgenic mice compared to WT (Figure 4). The groups did not vary significantly in the levels of IBA1 in the amygdala or hippocampus. No morphological signs of microglia activation were observed in the brain structures of transgenic mice.

### **Effects of CEF on the mRNA levels of the target genes (*Cst3*, *Becn1*) in the brain of a transgenic mouse PD model.**

Abundance of mRNA species in the amygdala or frontal cortex is summarized in Table 2. *Cst3*. According to two-way ANOVA, there were a significant influence of the "Genotype" factor ( $F_{1,15} = 32.1$ ,  $p < 0.001$ ), "Treatment" factor ( $F_{1,15} = 28.7$ ,  $p < 0.001$ ) and a significant effect of the interaction between the factors ( $F_{1,15} = 13.3$ ,  $p < 0.01$ ) on the mRNA levels of *Cst3* in the amygdala. LSD *post-hoc* test revealed that the parameter was significantly higher in the mice of "WT+saline" group vs. that in the mice of "WT+CEF" group ( $p < 0.001$ ), "Mut(PD)+saline" ( $p < 0.001$ ) or "Mut(PD)+CEF" ( $p < 0.001$ ) group and there was a tendency to decrease in the "Mut(PD)+CEF" group vs. "Mut(PD)+saline" group ( $p = 0.209$ ). No significant differences between the groups were found in the mouse hypothalamus ( $H(3, N=18) = 3.8$ ,  $p > 0.05$ ; data not shown). *Becn1*. According



to two-way ANOVA, there was a significant influence of the interaction between the factors of "Genotype" and "Treatment" ( $F_{1,12} = 10.2$ ,  $p < 0.01$ ) on the mRNA levels of *Becn1* in the mouse frontal cortex while the effects of the "Genotype" factor ( $F_{1,12} < 1$ ) or of the "Treatment" factor ( $F_{1,12} < 1$ ) were insignificant. LSD post-hoc test revealed that the parameter was significantly higher in mice of the "WT+saline" group vs. that in mice of the "Mut(PD)+saline" ( $p < 0.05$ ) or "WT+CEF" ( $p < 0.05$ ) group. There was a tendency to increase in the parameter in mice of the "Mut(PD)+CEF" vs. "Mut(PD)+saline" group ( $p = 0.055$ ). No significant differences between the groups were found in the rest brain structures studied (data not shown).

#### **Cst3 levels in serum and urine.**

There were no changes in Cst3 level in serum of transgenic mice vs. control ( $388.0 \pm 10.3$  vs.  $389.0 \pm 16.2$  ng/ml, respectively,  $p > 0.05$ ). Cst3 concentration in urine was higher in the transgenic mice ( $360.0 \pm 5.7$  vs  $140.0 \pm 1.70$  ng/ml in control,  $p < 0.01$ ) indicating some kidney problems in the model.

## **Discussion**

Neurodegeneration is tightly connected to neuroinflammation. Although microglial activation is enhanced in animal models of PD where lesions or toxins are used to induce death of neurons acutely, microglial involvement in PD remains a controversial issue. Particularly, many studies in humans have shown a lack of microglial activation in the vicinity of Lewy bodies [25]. Macrophage-derived chitinases (chitotriosidase and acid AMKase) as well as chitin-binding proteins lacking the enzymatic activity are regarded as markers of microglial activation and inflammation in the CNS [26-29]. *In vitro* studies showed that mutant  $\alpha$ -synuclein could activate microglia more powerfully than WT  $\alpha$ -synuclein [30]. *In vivo*, 12-month-old mice expressing the human A53T variant of  $\alpha$ -synuclein had an increased number of IBA1-positive microglial cells in the striatum [31]. However, another study revealed the significant changes in the levels of inflammatory markers in the striatum or s.nigra of 12-month-old transgenic mice overexpressing human mutant  $\alpha$ -synuclein only after a provocative injection of the inflammogen lipopolysaccharide at the age of seven-month-old [32]. Transgenic mice overexpressing the mutant  $\alpha$ -synuclein of younger age (seven-month-old) also differed from the WT mice in the microglia activation only at additive provocative procedure, a chronic mild stress model [33]. Our data supports those findings since we have not observed a significant difference in the mRNA levels of both chitinases genes studied in the brain between WT and transgenic mice. Those observations were further confirmed by IHC analysis with IBA1 marker. We found a significant reduction in IBA1 fluorescence in the striatum and

frontal cortex of transgenic mice and a relative increase in the parameter in the hypothalamus of mut(PD) mice compared to WT mice. It should be noted that no morphological signs of microglia activation were observed in the brain structures of transgenic mice. Relative decrease and increase of microglia abundance in certain brain structures seem to be a specific feature of microglia distribution in transgenic mice. Thus, neuroinflammation seemingly is not an early event in the PD-like pathology associated with the  $\alpha$ -synuclein overexpression and certain provocative impacts and / or aging factor are necessary to trigger its progression.

In our previous study, we have shown a suppressed autophagy in the dopaminergic structures of five-month-old transgenic mice overexpressing human A53T  $\alpha$ -synuclein compared to control WT mice as an early event at synucleinopathy progression [34]. Here we confirmed those findings on a reduced autophagy by LC3-II expression in the striatum of mut(PD) mice. We also found a decreased autophagic activity in the amygdala and hypothalamus but not in the hippocampus or frontal cortex in the transgenic mice. Interestingly, mRNA levels of *Becn1* encoding a regulatory protein of autophagy Beclin 1 were significantly reduced in the frontal cortex but not in the striatum in the transgenic mouse PD model. Autophagy marker LC3-II is a membrane-bound protein of autophagosomes and it is eliminated rapidly from the internal side of their membrane after their fusion with lysosomes. In general, its expression clearly reflects autophagy activity while the levels of Beclin1 are used as an additional parameter of autophagy regulation [35]. The results suggest the disturbances in autophagy activation in the striatum, amygdala, and hypothalamus in the transgenic mice and some alterations in the autophagy regulation in the frontal cortex of the mice. Thus, at early stage of PD-like pathology alterations in autophagy are not limited to the nigrostriatal system.

Cst3 induces fully functional active autophagy via the mTOR pathway; moreover, neuroprotective effects of Cst3 were prevented by autophagy inhibition with *Becn1* siRNA or 3-methyladenine [15]. Another regulatory pathway implies Cst3 direct inhibitory effect on neutral cysteine proteinases calpains that are involved in autophagy inhibition by means of mTOR-independent channels and apoptosis [36, 37]. In a recent study, neuroprotective effects of the elevated Cst3 expression at stroke were associated with autophagy induction in the affected brain regions. Moreover, exogenous Cst3 reduced the neurological deficits and infarct volume after brain ischemic injury, while 3-methyladenine partially reversed this neuroprotection [38]. Upregulation of Cst3 expression can represent a neuroprotective mechanism and may have therapeutic implications for treatment of neurodegenerative disorders [13, 39]. Indeed, the injections of Cst3 into s. nigra of transgenic mice expressing the human A53T variant of  $\alpha$ -synuclein had neuroprotective effects

by upregulating VEGF and autophagy and downregulating  $\alpha$ -synuclein and apoptosis [14]. Noteworthy, neuroprotection was associated with an increase in brain levels of both *Cst3* and *Cst3* mRNA [40].

Our findings on the decreased expression of *Cst3* mRNA in the striatum and amygdala and concurrent autophagy reduction in these brain regions of the transgenic mouse PD model are in a good agreement with the previous findings and support the notion about an important regulatory and neuroprotective role of *Cst3* at neurodegeneration. We also examined the peripheral levels of *Cst3* in the serum and urine of WT and transgenic mice. However, we did not find changes in the peripheral indices that would correspond to the decreased brain levels of *Cst3* expression. There were no significant differences in the serum *Cst3* levels between the mice of WT and transgenic PD model while the urine levels in transgenic mice were even higher than that in WT mice. Clinical data indicated higher serum levels of *Cst3* in PD patients compared to that in the healthy persons [41, 42] and a gradual increase in the parameter with the disease progression [41]. Hence, although serum *Cst3* level might be regarded as a peripheral biomarker of PD progression, its relation to the brain *Cst3* levels does not seem unambiguous, at least, for the early stages of the disease.

We also studied the potential effects of a multipotent antibiotic drug CEF, which has neuroprotective activity, on the modulation of mRNA levels of *Cst3* and *Becn1* genes. CEF revised cognitive and neuronal deficits in the animal models of PD and Alzheimer's disease [21, 43, 44]. Earlier we found the inhibitory effect of CEF treatment on the augmented autophagy level in the brain of a pharmacological A $\beta$ -induced model of Alzheimer's disease in mice [8]. However, its effects in PD models with the decreased basal levels of autophagy in the brain were not clear. In WT mice, the effects of CEF treatment were similar to those observed in the model of Alzheimer's disease [8] or traumatic brain injury [45]: there was a significant decrease in autophagy marker (*Becn1* mRNA cortical level) in mice chronically treated with CEF. In the transgenic mice treated with CEF, *Becn1* mRNA levels augmented up to the level of control WT mice. CEF reduced significantly *Cst3* mRNA levels in WT mice but did not produce further significant attenuation of this index in transgenic mice. It points to different mechanisms of CEF action in WT and transgenic mice. *Cst3* gene expression was found to be strongly positively regulated by TGF- $\beta$  via AP-1 transcription factor [46]. On the other hand, TGF- $\beta$  was markedly down-expressed following treatment with CEF in rat renal tissues [47]. Hence, the involvement of TGF- $\beta$  and AP-1 in the modulation of *Cst3* expression by CEF in the brain of WT mice might be suggested. In the transgenic mice, the contribution of

*Cst3* in the regulation of autophagy at CEF treatment does not seem significant due to the reduced initial levels of autophagy and *Cst3* expression. Monomeric and fibrillated  $\alpha$ -synuclein stimulates glutamate release [48], while glutamate-dependent promotion of mTOR phosphorylation leading to autophagy reduction was revealed in glial cells [49]. The up-regulation of glutamate transporter EAAT2 in glial cells is responsible for CEF-mediated neuroprotection via its ability to reduce extracellular glutamate levels and subsequent excitotoxicity [17]. Thus, one may suggest that the influence of CEF on autophagy in the transgenic mice overexpressing human A53T  $\alpha$ -synuclein is mediated mainly via the glutamatergic regulation.

## Conclusion

Apparently, a significant decrease in mRNA levels of *Cst3* in the brain revealed here and associated with the autophagy decline might be added to the early signs of synucleinopathy formation. Noteworthy, the alterations in autophagy were not limited to the nigrostriatal system of the transgenic mice but occurred in the amygdala, hypothalamus, and frontal cortex as well. The study first demonstrated the modulation of *Cst3* mRNA levels in the brain by CEF treatment. The effect was observed in WT mice but not in a transgenic mouse PD model. We did not reveal significant changes in the markers associated with inflammation in the brain of young transgenic mice overexpressing human A53T  $\alpha$ -synuclein. The results point to the potential of autophagy modulation at early stages of PD-like pathology and suggest *Cst3* as a promising therapeutic tool.

## Acknowledgments

The study was supported by budgetary funding for basic scientific research of the Scientific Research Institute of Physiology and Basic Medicine (theme No. AAAA-A16-116021010228-0; supported TAK, VMB, ABP, AAA, LAF, MVT, TGA, and MAT; covered the purchase of drugs (ceftriaxone, chloroquine) and major expenses for IHC analysis) and the Russian Foundation for Basic Research (grant No. 15-54-52029\_HHC-a; supported ABS and GSR; covered the purchase of animals and their husbandry and major expenses for qPCR and ELISA).

## Conflicts of Interest Statement

All authors claim that there are no conflicts of interest.



## References

- Rocha EM, De Miranda B, Sanders LH. Alpha-synuclein: Pathology, mitochondrial dysfunction and neuroinflammation in Parkinson's disease. *Neurobiol Dis.* 2018;109(Pt B):249–57. <https://doi.org/10.1016/j.nbd.2017.04.004>
- Jagmag SA, Tripathi N, Shukla SD, Maiti S, Khurana S. Evaluation of Models of Parkinson's Disease. *Front Neurosci.* 2016;503. <https://doi.org/10.3389/fnins.2015.00503>
- Deleidi M, Maetzler W. Protein clearance mechanisms of alpha-synuclein and amyloid-Beta in lewy body disorders. *Int J Alzheimers Dis.* 2012;2012:391438. <https://doi.org/10.1155/2012/391438>
- Cerri S, Blandini F. Role of Autophagy in Parkinson's Disease. *Curr Med Chem.* 2019;26(20):3702–18. <https://doi.org/10.2174/0929867325666180226094351>
- Seronie-Vivien S, Delanaye P, Pieroni L, Mariat C, Froissart M, Cristol JP, et al. Cystatin C: current position and future prospects. *Clin Chem Lab Med.* 2008;46(12):1664–86. <https://doi.org/10.1515/CCLM.2008.336>
- Amin F, Khan MS, Bano B. Mammalian cystatin and antagonists in brain diseases. *J Biomol Struct Dyn.* 2020;38(7):2171–96. <https://doi.org/10.1080/07391102.2019.1620636>
- Keppler D. Towards novel anti-cancer strategies based on cystatin function. *Cancer Lett.* 2006;235(2):159–76. <https://doi.org/10.1016/j.canlet.2005.04.001>
- Korolenko TA, Shintyapina AB, Pupyshv AB, Akopyan AA, Russkikh GS, Dikovskaya MA, et al. The regulatory role of cystatin C in autophagy and neurodegeneration. *Vavilov Journal of Genetics and Breeding.* 2019;23(4):390–7. <https://doi.org/10.18699/vj19.507>
- Pérez-González R, Sahoo S, Gauthier SA, Kim Y, Li M, Kumar A, et al. Neuroprotection mediated by cystatin C-loaded extracellular vesicles. *Sci Rep.* 2019;9(1):11104. <https://doi.org/10.1038/s41598-019-47524-7>
- Kaur G, Levy E. Cystatin C in Alzheimer's disease. *Front Mol Neurosci.* 2012;5:79. <https://doi.org/10.3389/fnmol.2012.00079>
- Gauthier S, Kaur G, Mi W, Tizon B, Levy E. Protective mechanisms by cystatin C in neurodegenerative diseases. *Front Biosci (Schol Ed).* 2011;3:541–54.
- Hu WD, Chen J, Mao CJ, Feng P, Yang YP, Luo WF, et al. Elevated Cystatin C Levels Are Associated with Cognitive Impairment and Progression of Parkinson Disease. *Cogn Behav Neurol.* 2016;29(3):144–9. <http://dx.doi.org/10.1097/wnn.000000000000100>
- Xu L, Sheng J, Tang Z, Wu X, Yu Y, Guo H, et al. Cystatin C prevents degeneration of rat nigral dopaminergic neurons: in vitro and in vivo studies. *Neurobiol Dis.* 2005;18(1):152–65. <https://doi.org/10.1016/j.nbd.2004.08.012>
- Zou J, Chen Z, Wei X, Chen Z, Fu Y, Yang X, et al. Cystatin C as a potential therapeutic mediator against Parkinson's disease via VEGF-induced angiogenesis and enhanced neuronal autophagy in neurovascular units. *Cell Death Dis.* 2017;8(6):e2854. <https://doi.org/10.1038/cddis.2017.240>
- Tizon B, Sahoo S, Yu H, Gauthier S, Kumar AR, Mohan P, et al. Induction of autophagy by cystatin C: a mechanism that protects murine primary cortical neurons and neuronal cell lines. *PLoS One.* 2010;5(3):e9819. <https://doi.org/10.1371/journal.pone.0009819>
- Yimer EM, Hishe HZ, Tuem KB. Repurposing of the  $\beta$ -Lactam Antibiotic, Ceftriaxone for Neurological Disorders: A Review. *Front Neurosci.* 2019;13:236. <https://doi.org/10.3389/fnins.2019.00236>
- Tai CH, Bellesi M, Chen AC, Lin CL, Li HH, Lin PJ, et al. A new avenue for treating neuronal diseases: Ceftriaxone, an old antibiotic demonstrating behavioral neuronal effects. *Behav Brain Res.* 2019;364:149–56. <https://doi.org/10.1016/j.bbr.2019.02.020>
- Gelders G, Baekelandt V, Van der Perren A. Linking Neuroinflammation and Neurodegeneration in Parkinson's Disease. *J Immunol Res.* 2018;2018:4784268. <https://doi.org/10.1155/2018/4784268>
- Li T, Le W. Biomarkers for Parkinson's Disease: How Good Are They? *Neurosci Bull.* 2020;36(2):183–94. <https://doi.org/10.1007/s12264-019-00433-1>
- Tikhonova MA, Amstislavskaya TG, Belichenko VM, Fedoseeva LA, Kovalenko SP, Pisareva EE, et al. Modulation of the expression of genes related to the system of amyloid-beta metabolism in the brain as a novel mechanism of ceftriaxone neuroprotective properties. *BMC Neurosci.* 2018;19(Suppl 1):13. <https://doi.org/10.1186/s12868-018-0412-5>
- Tikhonova MA, Ho SC, Akopyan AA, Kolosova NG, Weng JC, Meng WY, et al. Neuroprotective effects of ceftriaxone treatment on cognitive and neuronal deficits in a rat model of accelerated senescence. *Behav Brain Res.* 2017;330:8–16. <https://doi.org/10.1016/j.bbr.2017.05.002>
- Iwai-Kanai E, Yuan H, Huang C, Sayen MR, Perry-Garza CN, Kim L, et al. A method to measure cardiac autophagic flux in vivo. *Autophagy.* 2008;4(3):322–9. <https://doi.org/10.4161/auto.5603>
- Ruijter JM, Ramakers C, Hoogaars WM, Karlen Y, Bakker O, van den Hoff MJ, et al. Amplification efficiency: linking baseline and bias in the analysis of quantitative PCR data. *Nucleic Acids Res.* 2009;37(6):e45. <https://doi.org/10.1093/nar/gkp045>
- Pupyshv AB, Tikhonova MA, Akopyan AA, Tenditnik MV, Dubrovina NI, Korolenko TA. Therapeutic activation of autophagy by combined treatment with rapamycin and trehalose in a mouse MPTP-induced model of Parkinson's disease. *Pharmacol Biochem Behav.* 2019;177:1–11. <https://doi.org/10.1016/j.pbb.2018.12.005>

25. Streit WJ, Xue QS, Tischer J, Bechmann I. Microglial pathology. *Acta Neuropathol Commun*. 2014;2:142. <https://doi.org/10.1186/s40478-014-0142-6>
26. Correale J, Fiol M. Chitinase effects on immune cell response in neuromyelitis optica and multiple sclerosis. *Mult Scler*. 2011;17(5):521–31. <https://doi.org/10.1177/1352458510392619>
27. Hall S, Surova Y, Öhrfelt A; Swedish BioFINDER Study, Blennow K, Zetterberg H, Hansson O. Longitudinal Measurements of Cerebrospinal Fluid Biomarkers in Parkinson's Disease. *Mov Disord*. 2016;31(6):898–905. <https://doi.org/10.1002/mds.26578>
28. Xiao Q, Yu W, Tian Q, Fu X, Wang X, Gu M, et al. Chitinase1 contributed to a potential protection via microglia polarization and A $\beta$  oligomer reduction in D-galactose and aluminum-induced rat model with cognitive impairments. *Neuroscience*. 2017;355:61–70. <https://doi.org/10.1016/j.neuroscience.2017.04.050>
29. Steinacker P, Verde F, Fang L, Feneberg E, Oeckl P, Roeber S, et al. Chitotriosidase (CHIT1) is increased in microglia and macrophages in spinal cord of amyotrophic lateral sclerosis and cerebrospinal fluid levels correlate with disease severity and progression. *J Neurol Neurosurg Psychiatry*. 2018;89(3):239–47. <http://dx.doi.org/10.1136/jnnp-2017-317138>
30. Zhang W, Dallas S, Zhang D, Guo JP, Pang H, Wilson B, et al. Microglial PHOX and Mac-1 are essential to the enhanced dopaminergic neurodegeneration elicited by A30P and A53T mutant alpha-synuclein. *Glia*. 2007;55(11):1178–88. <https://doi.org/10.1002/glia.20532>
31. Sirabella R, Sisalli MJ, Costa G, Omura K, Ianniello G, Pinna A, et al. NCX1 and NCX3 as potential factors contributing to neurodegeneration and neuroinflammation in the A53T transgenic mouse model of Parkinson's Disease. *Cell Death Dis*. 2018;9(7):725. <https://doi.org/10.1038/s41419-018-0775-7>
32. Gao HM, Zhang F, Zhou H, Kam W, Wilson B, Hong JS. Neuroinflammation and alpha-synuclein dysfunction potentiate each other, driving chronic progression of neurodegeneration in a mouse model of Parkinson's disease. *Environ Health Perspect*. 2011;119(6):807–14. <https://doi.org/10.1289/ehp.1003013>
33. Wu Q, Yang X, Zhang Y, Zhang L, Feng L. Chronic mild stress accelerates the progression of Parkinson's disease in A53T  $\alpha$ -synuclein transgenic mice. *Exp Neurol*. 2016;285(Pt A):61–71. <https://doi.org/10.1016/j.expneurol.2016.09.004>
34. Pupyshv AB, Korolenko TA, Akopyan AA, Amstislavskaya TG, Tikhonova MA. Suppression of autophagy in the brain of transgenic mice with overexpression of A53T-mutant  $\alpha$ -synuclein as an early event at synucleinopathy progression. *Neurosci Lett*. 2018;672:140–4. <https://doi.org/10.1016/j.neulet.2017.12.001>
35. Klionsky DJ, Abdalla FC, Abeliovich H, Abraham RT, Acevedo-Arozena A, Adeli K, et al. Guidelines for the use and interpretation of assays for monitoring autophagy. *Autophagy*. 2012;8(4):445–544. <http://dx.doi.org/10.4161/auto.19496>
36. Ahumada-Castro U, Silva-Pavez E, Lovy A, Pardo E, Molgó J, Cárdenas C. MTOR-independent autophagy induced by interrupted endoplasmic reticulum-mitochondrial Ca $^{2+}$  communication: a dead end in cancer cells. *Autophagy*. 2019;15(2):358–61. <https://doi.org/10.1080/15548627.2018.1537769>
37. Williams A, Sarkar S, Cuddon P, Ttofi EK, Saiki S, Siddiqi FH, et al. Novel targets for Huntington's disease in an mTOR-independent autophagy pathway. *Nat Chem Biol*. 2008;4(5):295–305. <https://doi.org/10.1038/nchembio.79>
38. Fang Z, Feng Y, Li Y, Deng J, Nie H, Yang Q, et al. Neuroprotective Autophagic Flux Induced by Hyperbaric Oxygen Preconditioning is Mediated by Cystatin C. *Neurosci Bull*. 2019;35(2):336–46. <https://doi.org/10.1007/s12264-018-0313-8>
39. Wang R, Chen Z, Fu Y, Wei X, Liao J, Liu X, et al. Plasma Cystatin C and High-Density Lipoprotein Are Important Biomarkers of Alzheimer's Disease and Vascular Dementia: A Cross-Sectional Study. *Front Aging Neurosci*. 2017;9:26. <https://doi.org/10.3389/fnagi.2017.00026>
40. Kaur G, Mohan P, Pawlik M, DeRosa S, Fajiculy J, Che S, et al. Cystatin C rescues degenerating neurons in a cystatin B-knockout mouse model of progressive myoclonus epilepsy. *Am J Pathol*. 2010;177(5):2256–67. <https://doi.org/10.2353/ajpath.2010.100461>
41. Chen WW, Cheng X, Zhang X, Zhang QS, Sun HQ, Huang WJ, et al. The expression features of serum Cystatin C and homocysteine of Parkinson's disease with mild cognitive dysfunction. *Eur Rev Med Pharmacol Sci*. 2015;19(16):2957–63.
42. Xiong Y, Mahmood A, Chopp M. Current understanding of neuroinflammation after traumatic brain injury and cell-based therapeutic opportunities. *Chin J Traumatol*. 2018;21(3):137–51. <https://doi.org/10.1016/j.cjtee.2018.02.003>
43. Ho SC, Hsu CC, Pawlak CR, Tikhonova MA, Lai TJ, Amstislavskaya TG, et al. Effects of ceftriaxone on the behavioral and neuronal changes in an MPTP-induced Parkinson's disease rat model. *Behav Brain Res*. 2014;268:177–84. <https://doi.org/10.1016/j.bbr.2014.04.022>
44. Weng JC, Tikhonova MA, Chen JH, Shen MS, Meng WY, Chang YT, et al. Ceftriaxone prevents the neurodegeneration and decreased neurogenesis seen in a Parkinson's disease rat model: An immunohistochemical and MRI study. *Behav Brain Res*. 2016;305:126–39. <https://doi.org/10.1016/j.bbr.2016.02.034>
45. Cui C, Cui Y, Gao J, Sun L, Wang Y, Wang K, et al. Neuroprotective effect of ceftriaxone in a rat model of traumatic brain injury. *Neurol Sci*. 2014;35(5):695–700. <https://doi.org/10.1007/s10072-013-1585-4>
46. Huh C, Nagle JW, Kozak CA, Abrahamson M, Karlsson S. Structural organization, expression and chromosomal mapping of the mouse cystatin-C-encoding gene (Cst3). *Gene*. 1995;152(2):221–6. [https://doi.org/10.1016/0378-1119\(94\)00728-B](https://doi.org/10.1016/0378-1119(94)00728-B)
47. Abdel-Daim MM, El-Sayed YS, Eldaim MA, Ibrahim A. Nephroprotective efficacy of ceftriaxone against cisplatin-induced subchronic renal fibrosis in rats. *Naunyn Schmiedeberg Arch Pharmacol*. 2017;390:301–9. <https://doi.org/10.1007/s00210-016-1332-5>

48. Sarafian TA, Littlejohn K, Yuan S, Fernandez C, Cilluffo M, Koo BK, et al. Stimulation of synaptoneurosome glutamate release by monomeric and fibrillated  $\alpha$  synuclein. *J Neurosci Res.* 2017;95(9):1871–87. <https://doi.org/10.1002/jnr.24024>
49. Lopez-Colome MA, Martinez-Lozada Z, Guillem AM, Lopez E, Ortega A. Glutamate transporter-dependent mTOR phosphorylation in Muller glia cells. *ASN Neuro.* 2012;4(5):e00095. <http://dx.doi.org/10.1042/AN20120022>

**Tables**

**Table 1.** Reference and target genes PCR primer sequences (5' - 3'), amplicon size.

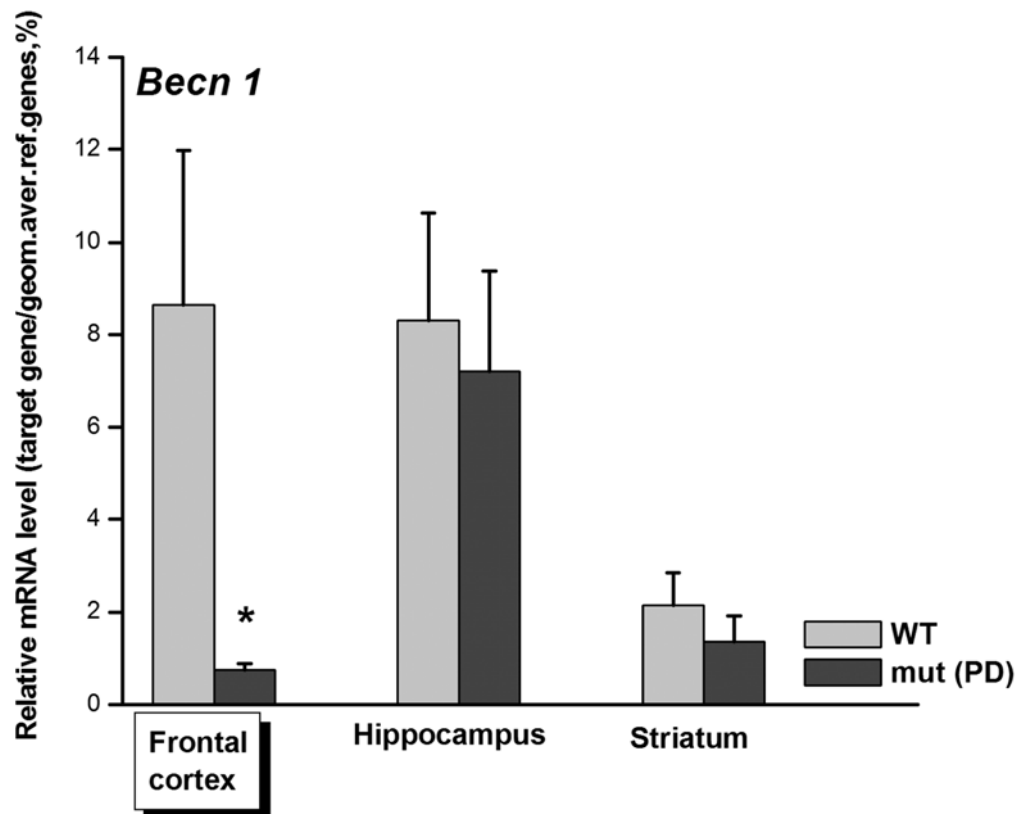
Symbol	Sequence (5' - 3')		Amplicon size (bp)
	Forward Primer	Reverse Primer	
<b>Reference genes</b>			
<i>Gapdh</i>	GCTCCTCCCTGTTCCAGAGAC	CCAATACGGCCAAATCCGTTCA	103
<i>Actb</i>	TTCTACAATGAGCTGCGTGTG	GGGGTGTGAAGGTCTCAAA	102
<i>Rpl13a</i>	CATGAGGTCGGGTGGAAGTA	TTCCGTAACCTCAAGATCTGC	110
<i>Ppia</i>	AAAGTTCCAAAGACAGCAGAAAA	GCCAGGACCTGTATGCTTTAG	207
<b>Target genes</b>			
<i>Cst3</i>	AGGAGGCAGATGCCAATGAG	GGGCTGGTCATGGAAAGGA	227
<i>Chit1</i>	CGGCAGGAACATAATCTTCCAT	TGGGCGTGGCTCAGGTAT	70
<i>Chia1</i>	TTTTGGCAGTGCAATGG	GCAGCAATTACAGCTGGTATCAA	80
<i>Becn1</i>	GAACTCACAGCTCCATTACTTA	ATCTTCGAGAGACACCATCC	121

**Table 2.** Relative mRNA levels of *Cst3* and *Becn1* in the brain structures. Data are presented as the Mean±S.E.M. of the values obtained in an independent group of animals (n=5-6 per group). Statistically significant differences: \*p < 0.05, \*\*\*p < 0.001 vs. "WT+Saline" group.

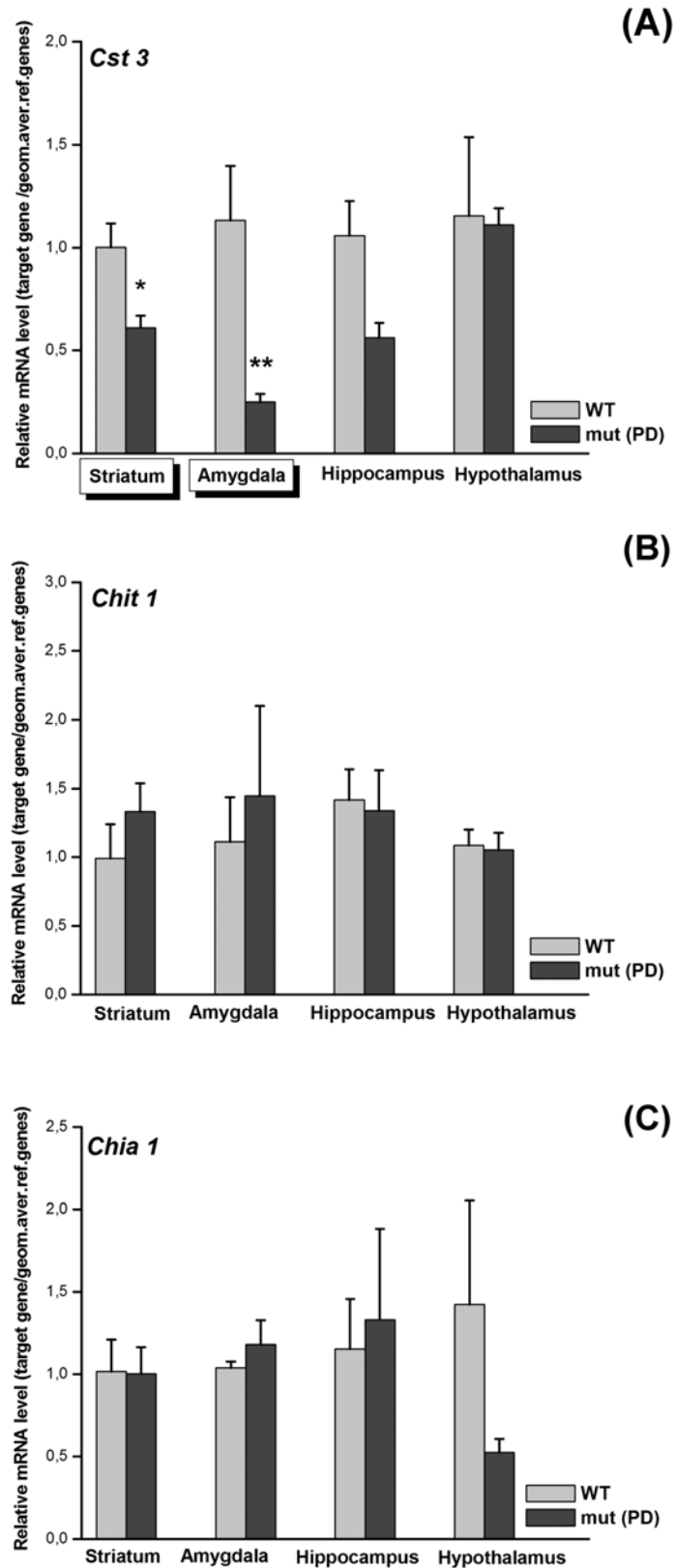
Gene, brain structure	Group			
	WT+Saline	WT+CEF	Mut (PD)+Saline	Mut (PD)+CEF
<i>Cst3</i> , amygdala	1.058 ± 0.1791	0.271 ± 0.0866***	0.244 ± 0.0342***	0.095 ± 0.0308***
<i>Becn1</i> , frontal cortex	8.65 ± 3.333	0.69 ± 0.346*	0.75 ± 0.140*	6.99 ± 2.185

**Figures**

**Figure 1.** Effect of the overexpression of A53T-mutant  $\alpha$ -synuclein on mRNA levels of *Becn1* in the frontal cortex, hippocampus, and striatum in 5 m.o. mice. The data are expressed as the means  $\pm$  SEMs of the values obtained in an independent group of animals ( $n=5-6$  per group). Statistically significant differences: \*  $p<0.05$  vs. WT mice.

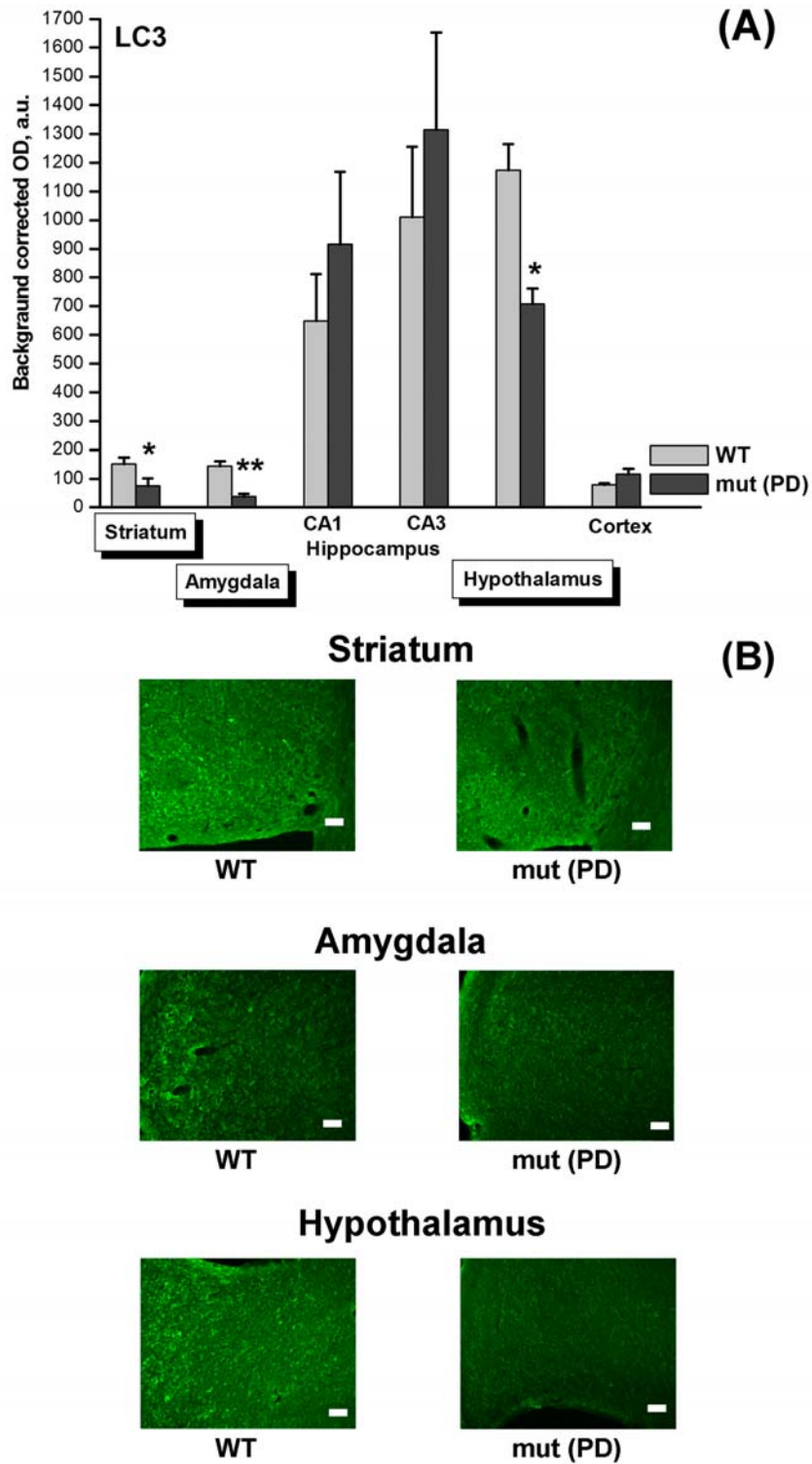


**Figure 2.** Effect of the overexpression of A53T-mutant  $\alpha$ -synuclein on mRNA levels of *Cst3* (A), *Chit1* (B), and *Chia1* (C) in the striatum, amygdala, hippocampus, and hypothalamus in 5 m.o. mice. The data are expressed as the means  $\pm$  SEMs of the values obtained in an independent group of animals ( $n=5-6$  per group). Statistically significant differences: \*  $p<0.05$ , \*\*  $p<0.01$  vs. WT mice.

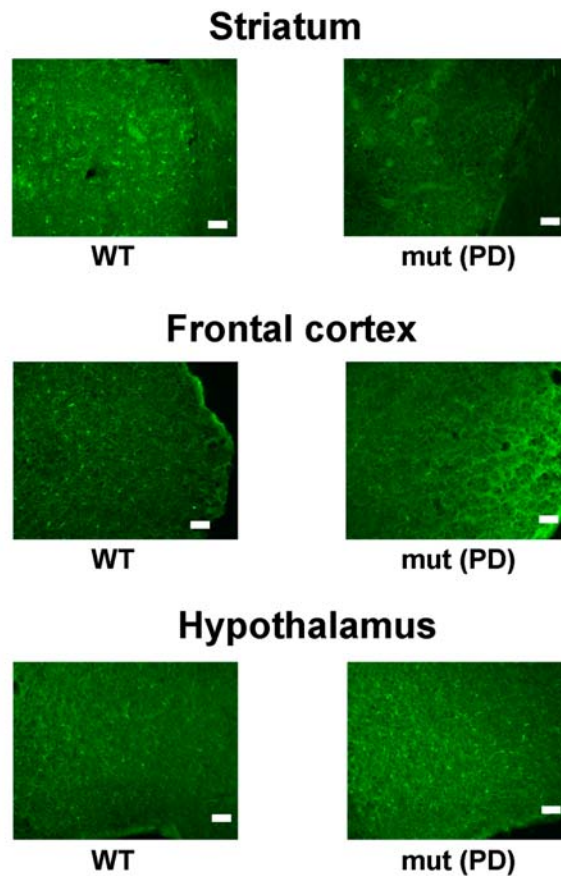
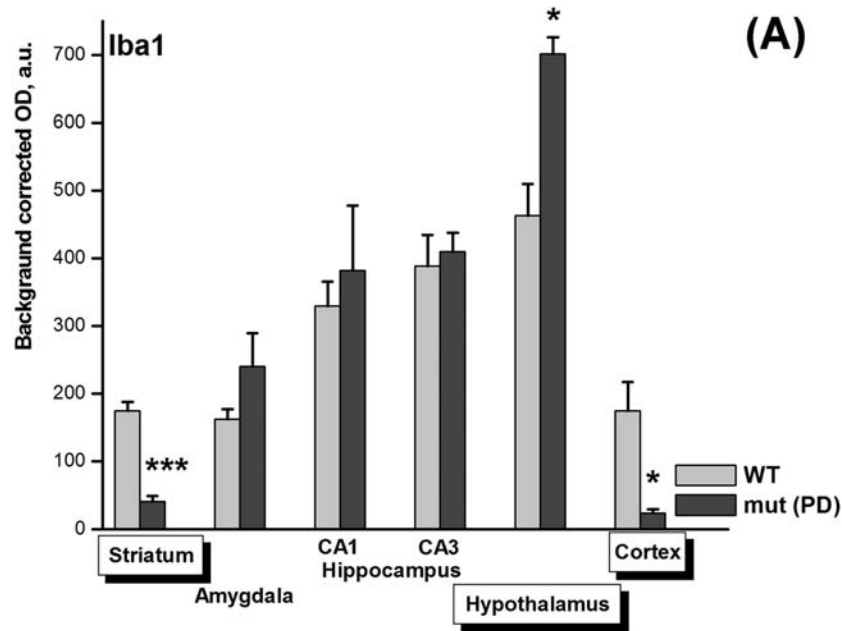




**Figure 3.** Effect of the overexpression of A53T-mutant  $\alpha$ -synuclein on autophagy activity measured by quantified immunoreactivity of LC3-II in the striatum, amygdala, hippocampal CA1 and CA3 areas, hypothalamus, and frontal cortex in 5 m.o. mice. A: Quantitative results. The data are expressed as the Mean $\pm$ S.E.M. of the values obtained in an independent group of animals ( $n=3-6$  per group). Statistically significant differences: \*  $p<0.05$ , \*\*  $p<0.01$  vs. WT mice. B: LC3-II immunoreactivity in the striatum, amygdala, and hypothalamus. Magnification, 200 $\times$ ; bar, 50  $\mu$ m.



**Figure 4.** Effect of the overexpression of A53T-mutant  $\alpha$ -synuclein on the expression of microglial marker IBA1 in the striatum, amygdala, hippocampal CA1 and CA3 areas, hypothalamus, and frontal cortex in 5 m.o. mice. A: Quantitative results. The data are expressed as the Mean $\pm$ S.E.M. of the values obtained in an independent group of animals ( $n=3-6$  per group). Statistically significant differences: \*  $p<0.05$ , \*\*\*  $p<0.001$  vs. WT mice. B: IBA1 immunoreactivity in the striatum, frontal cortex, and hypothalamus. Magnification, 200 $\times$ ; bar, 50  $\mu$ m.



# CONFLICT AND CONFLICT RESOLUTIONS EXPERIENCED BY EARLY CAREER DOCTORS IN THE NIGERIAN HEALTH SECTOR: A QUALITATIVE REPORT

O. Olaopa<sup>1</sup>, O. Adebayo<sup>1</sup>, I. Adufe<sup>2</sup>, M.A. Adeniyi<sup>3</sup>, S. Oiwoh<sup>4</sup>, E. Grillo<sup>5</sup>, O. Efuntoye<sup>1</sup>, I. Oduyemi<sup>1</sup>, O. Ogunsuji<sup>1</sup>, A. Sokomba<sup>6</sup>, K.A. Durowade<sup>3</sup>

<sup>1</sup>University College Hospital Ibadan, Oyo State, Nigeria

<sup>2</sup>University of Ibadan, Ibadan, Oyo State, Nigeria

<sup>3</sup>Federal Teaching Hospital, Ido-Ekiti, Ekiti State, Nigeria

<sup>4</sup>LAUTECH Teaching Hospital, Ogbomosho, Oyo State, Nigeria

<sup>5</sup>Federal Medical Centre, Abeokuta, Ogun State, Nigeria

<sup>6</sup>Ahmadu Bello University Teaching Hospital, Zaria, Kaduna State, Nigeria

## Abstract

**Background.** Conflicts across professional workgroup and hierarchies inundate the clinical workplace. Early Career Doctors (ECDs) are also affected either as victims or as a provocateur/perpetrator. The effects of conflict at their workplaces have both significant positive and negative dimensions and impacts on ECDs. Little has been reported about conflict among ECDs in Nigeria.

**Thus,** this study explored the issue of conflict and conflict resolution among ECDs in Nigeria, in a bid to elicit information on the causes, consequences, perpetrators and victims.

**Method.** This was a qualitative study, using Focus Group Discussions (FGD) to explore information on conflict and conflict management among purposively selected key respondents (n = 14) from seven tertiary hospitals in Nigeria. The respondents are ECDs who were leaders and representatives of other ECDs in their various hospitals. Two FGDs were conducted.

**Results.** The result showed that conflict is inescapable in clinical settings and occurred at different levels. The perpetrators are varieties of health workers, and most are task-related conflicts, although there are relational ones. The conflicts with the government on labour-related issues are also frequent. The lack of job description and specification and power struggle among others were highlighted as the drivers of conflicts between ECDs and other health-workers.

**Conclusion.** The findings of the study were discussed, and suggestions were made to reduce its effect, which would require structural solutions to mitigate at different levels and the diverse players in the health sectors.

## Keywords

conflicts • early career doctors • Nigeria • doctors • workplace • clinical • hospital

## Introduction

The concept of conflict has different definitions by different scholars depending on disciplines [1, 2]. One of such defined conflict as a process in which various factors, likely but not necessarily including, conflicting interests, adverse effects, such as anger and dislike, negative cognition such as stereotypes, real or imagined wrongs, and actual or anticipated thwarting, result in an individual or group taking actions that are incompatible with the interest of other individuals or groups [3]. Conflict is a complex phenomenon, which exists in all aspects of human interactions; hence, health organizations and institutions are inclusive [1, 2, 4]. This phenomenon occurs amongst doctors, across

hierarchies, the intra-professional and interprofessional group within hospitals [2]. The Nigerian health sector is plagued by problems that lead to conflicts among human resources for health/health workforce, with their employers or government [1].

The consequences of conflicts may be positive or negative in the outcome [1]. Consequences are negative when conflicts are not adequately managed and are allowed to degenerate to a dysfunctional status which is evident from reduced turnover among employees, reduced productivity, mental health problems, and outright violence [1]. While potential positive consequences are social change, decision-making,

reconciliation, group unity, group cooperation, the inspiration of creativity, shared and respect of opinions, and improved future communication, among others.

The occurrence of conflict among healthcare workers hinders the quality of services rendered [1]. Therefore, conflict resolution is essential to avoid the breakdown of teams, especially management teams in healthcare and promote peace and harmony among its workers.

There is a paucity of data as regards to conflict among ECDs in Nigeria. Thus, the study explored the issue of conflict and conflict resolution among ECDs in Nigeria, in a bid to elicit information on the causes, consequences, perpetrators and victims. Analysis of these problems will improve workplace issues and give the insight to help reduce the poor indices and outcomes of healthcare catastrophes affecting low-and medium-income countries such as Nigeria.

This article reports the results of the qualitative exploration among ECDs on the conflict at the clinical workplace. The study is part of the Challenges of residency training and early career doctors in Nigeria (CHARTING) study, which is a mixed study design to explore themes among Early Career Doctors (ECDs) in Nigeria [5-7]. One of the significant themes includes workplace issues.

## Methods

### **Study area**

The study was conducted during two official gatherings of the Nigerian Association of Resident Doctors (NARD), where leaders/delegates of each branch converge for the meeting. The first was during the South West regional caucus meeting held at LAUTECH Teaching Hospital, Ogbomosho while the second was an ordinary general meeting of NARD held at Yenagoa, Bayelsa State. Statutorily the National Executive Committee(NEC), National Executive Council and Expanded National Executive Council attend these meetings although other delegates who are members but non-NEC members may attend [8].

### **Study design**

The study used Focus Group Discussion (FGD), which is a qualitative method to unravel the conflict and conflict resolution experienced among early-career doctors in the Nigerian health sector. Purposive sampling was used to recruit participants for the FGD.

### **Study population**

Two FGD sessions were conducted among fourteen consenting respondents from seven residency-training institutions in Nigeria. The sample size was limited to only two geo-political

zones (8 from South-west and six from South-south) in Nigeria due to accessibility and availability of participants. However, the study population has a more in-depth knowledge of the subject matter as they are mostly involved in conflict resolution being mainly leaders of their centres.

### **Data collection**

A semi-structured FGD guide was designed to address specific aspects of conflict and conflict resolution issues experienced by respondents. FGD was used to elicit responses from participants. The guide was carefully designed and tested to ensure that the questions are simple, clear and short. These actions were to avoid the situation; the participants end up discussing the questions itself, rather than what the questions being elicited [9]. Also, questions were constructed in an open-ended format, ensuring that probe, follow up and exit questions are embedded, which helped elicit correct responses without leaving any stone unturned.

Two sessions were conducted until data saturation was achieved, and each session lasted between 60-90 minutes. A trained moderator guided each session while trained research assistants managed note takings and recordings and other roles. The participants were informed before the sessions. All participants gave oral and written consent to participate in the study. Discussions were digitally recorded with participant consent to ensure that the details of the conversations are adequately captured. Previous qualitative reports on other themes have been published from the qualitative aspect of this project [10, 11].

### **Sample Description**

The distribution of the respondents based on professional cadre, gender, geo-political zones and training institutions are shown in Table 1. All participants were ECDs who are medical practitioners with a degree in medicine or dentistry and are undergoing internship, residency training or are medical officers and equivalent below the rank of a Principal Medical/Dental Officer (PMO/PDO) [5, 8].

### **Analysis**

Audio-recordings were correctly transcribed verbatim by research assistants. Transcripts were analysed and thematically coded according to the research themes that emerged from the discussion. Coding was done using the NVivo 12 program. Open coding was also used to identify specific themes that emerged from the discussions. Themes and subthemes were generated and supported with illustrative quotations from the discussion.

### **Ethical considerations**

Ethical approval was obtained from the National Ethics Review Committee, Federal Ministry of Health before fieldwork

commenced (NHREC Approval Number NHREC/01/01/2007-26/06/2019). Written and verbal consent was received from the participants before conducting the sessions and before audio-recording. All information obtained from each participant, including personal details, was treated with the utmost confidentiality.

## Results

The result of our analysis showed that conflict is a common occurrence in clinical settings, and, it is inevitable. Four themes were identified, which represents perpetrators, causes, consequences of conflict and conflict resolution strategies. These themes were presented with supportive quotes to buttress respondents' views further.

### **Perpetrators of conflict**

The study participants identified the perpetrators of conflict as all health workers within the hospital:

*"Starting from the ward, nurses you are definitely going to have conflict with them" "You are going to have problems with the cleaner" "You are going to be having problems with the lab technicians" "You are going to have problem with the hospital administrator" "So in summary working in a teaching hospital as a resident doctor you are going to have conflict with everyone" (R6 SW).*

*"Some pharmacist that disregards doctor's prescription of some drugs" (R2 SW).*

*"Rift between we and other personnel in the workplace span across the nurses up to the cleaners" (R6 SS).*

*"There is also conflict between patients" (R4 SS).*

*"Also, there is this communication gap between health care workers and patients" (R3 SS).*

### **Causes of conflict**

As reflected in the below verbatim expressions, drivers of conflict within the hospitals vary from lack of job description and specification to power struggle to lack of respect to poverty to mention a few:

*"Well, in a system where nothing works, and you are a doctor in that system you are going to have a conflict with everybody (definitely)" (R6 SW).*

*"Like us in surgery, you see us sometimes roll the patient into the suite because the patient needs emergency craniotomy, and the health attendant cannot be found and all that. So you keep on doing somebody else's job, and that is what causes conflict so you can have a backlash between a doctor, health attendant and all that" "So I think that is just the bane of our problem in the health sector. No job description and no job specification" (R4 SW).*

*"A lot of people don't know what they are supposed to do, when they are supposed to do it and how they are supposed to do it" (R4 SS).*

*"At every available opportunity, they want to rub shoulders with the doctor, want to have whatever the doctor gets in the system. As you all know there is a hierarchy duties assigned that doctor is the head of the medical team, but the strategic roles the doctors play is not really appreciated by other workers in the health system, and this has really caused interpersonal conflict and has really affected service delivery" (R6 SS).*

*"If I don't give respect to my colleague no other person will give respect to my colleague" "There is no respect first amongst ourselves (it's been lost), and we have to find a way to go back because if we don't have respect for ourselves nobody will have respect for you" "For instance, where a junior doctor is slapped because a nurse said something (you understand) because you are having issues with a nurse or a cleaner and you are not corrected away from the presence of other personnel's, but you are brought down in front of them" (R4 SS).*

*"Poverty is the one major issue in this our environment. A patient comes in poor, comes in bad and you cannot do anything for the patient because the patient came in without nothing and you cannot access anything you now become the culprit, you become the evil person and then that is where another issue comes in like doctor battering, or doctors abuse comes to play, so that is another factor for conflict in our hospitals"(R4 SS).*

### **Consequences/effect of conflict**

Generated transcripts revealed that in most cases, patients are the victims of conflict.

*"The consequence is that most of the time the patient suffers because when you do people's job, you will get to the point that you cannot continue" "It is the patient that bears the brunt of the conflict" (R3 SW).*

*"Generally, the patient will bear the brunt but generally most times it extends to the populace when you have conflict, rivalry, strike action, lockdown you know the whole country and populace bear the whole brunt" (R5 SW).*

*"There is an African proverb that says when two elephant fights the grass suffers" "You can imagine when you tell a nurse that sister give that patient IM injection and she is like why can't you do it? Don't you have hands? And at the end of the day, the patient ends up not getting the injection, and you might end up losing that patient" (R1 SS).*

*"When the health workers are fighting the care, we give to the patient is very poor" "There is decay in the health system because of this conflict" (R1 SS).*



### **Assessment of conflict resolution (interventions/strategies)**

Factors that can be used to resolve conflict are attractive remuneration, professional laws, mutual respect to mention a few. As opined by some of the participants:

*“There should be reward system in place” (R7 SW).*

*“Government is responsible, and they do what is expected of them; they pay salaries as at when due, you increase salary as at when due then people will not go on strike and if there is need to have conflict there are options that people will consider before any association go on strike” (R3 SW).*

*“Then also the rights of doctors or health care worker should also be respected because conflict does not only come from the workers. It also comes from management and workers, so this staff-management relationship has to be good too because in this setting we always see management like ok they are the ones that are at the helm of affairs so whatever they do is right. For instance, in our society also there is this issue of no work no pay, but there is no pay no work” “Then provision of facilities if facilities are provided, and the environment is made in a good manner I believe that workers or staffs we have the necessary equipment’s to work, and there would be no conflict of any sort” (R3 SS).*

*“I think we should have laws backing each and every profession; we should have laws backing them that if you come to my field, you will pay a penalty, if I go to your field or if I do what you are supposed to do there’s a penalty it will help us know our boundaries” (R1 SS).*

*“And I think also the pay sometimes as doctor we should not just look at...when we go for pay increment, we should just think of ourselves, but we should think of carrying the ally health workers along because if our pay is very good and their pay is poor the zeal to work will not be there on their part, and we can’t do everything so we should also carry them along when we are going for pay increment or negotiating our salaries scale we should also think of them because we can’t do all the works ourselves” (R5 SS).*

*“People should know their job and stay in their area of calling. Doctor should not do porter’s job carrying blood. Pharmacist should not treat patients. You know your calling so stay in your area of calling” (R5 SW).*

*“Mutual respect is also very important, what makes you think you are the most important person. I think we should all respect one another no matter the category of the worker that you are working because all of us at the end of the day are humans. Some of these persons that we feel we are better than they also have people they control and so we should be able to understand that and appreciate these facts and give each other respect” (R3 SS).*

### **Discussion**

The themes that emerged from the study indicated that conflict occurs commonly between ECDs and other health care professionals. The conflict appears to be unavoidable due to regular human interactions that take place in the clinical workplace, just like any other workplace [3, 12]. A quantitative study conducted amongst doctors and nurses in two public hospitals in Ido-Ekiti, Nigeria revealed that healthcare workers agree to the existence of conflict at the workplace [1, 13]. Such conflicts involve many of the categories of the health workforce and not limited to doctors, especially ECDs, and this is similar to the finding of other studies on the conflict between doctors and other health workers [14, 15]. Conflict can occur between residents, with their consultants or hospital management, and other healthcare workers within hospitals and even patients [16, 17].

While there are mixed results regarding the usual provocateur of conflicts in hospital settings, the respondents agreed on the increased likelihood of conflict with all categories of the health workforce [16]. However, the study did not explore the reasons for this diversity in such conflict against the ECDs or doctors. The clinical workplace where doctors and other health workers work is however frosted, with stressful conditions, which most likely predispose them to conflict [1, 13]. These stressful conditions are further worsen in Nigeria due to infrastructural deficiencies and inadequacies and organizational failure, which the respondents pointed out. These deficiencies and inadequacies imposed stress may explain to a large extent the precipitation in such setting rather than mere power play which may exist between a doctor or other health workers or even between a doctor and patients [18]. Furthermore, many of the conflicts with other health workers are task-related as opined by respondents; some can be inferred to be relational related. The later serves as a potential source of unfavourable outcome and dysfunction in the health system while the former may be a great source of improved efficiency to the system [19, 20].

The respondents also highlighted the recurrent role of the Government as a provocateur of conflicts in the public health system in the way she handles labour issues, especially as it relates to wages and welfares of doctors in the Nigerian healthcare system [14]. This highlight is not unusual, considering the respondents are representative of their various unions. While many studies have elucidated why doctors as a group may readily confront the Government when the doctor group interest is threatened is inherent in being a powerful and privileged group (18). This capacity may further be buttressed by the fact that they have historically succeeded in pursuing their interests



as a professional group [21]. Most of the benefits that have accrued to the group from Government such as salary review and other welfare issues in Nigeria have been as a result of the very virulent strikes and other labour forms of labour agitations [3].

Generally, the precipitation of conflict appears to be human resources management variable of staff relationship unlike another study which has pointed out another staff-related factor; staff shortage which may arise from inadequate supply and attrition/migration [16, 22]. While that study was questionnaire-based, this study design is qualitative and by nature allows hidden themes to be explored. Although, our respondents are from tertiary centres which are relatively better staffed than other levels of care in Nigeria notwithstanding the general doctor-patient ratio in Nigeria and may not be bothered with a staff-patient ratio in respect to the conflict in the workplace [23].

Conflict in health workplace poses a negative effect on the health system and the quality of services, particularly the patients whether in conflicts between the health worker and the doctor or cases of an industrial dispute with the ECDs. All these undermine the effective functioning of the clinical workplace and the output of the workers [13].

Furthermore, the respondents highlighted the significant causes of conflict in clinical settings as lack of job description and specification, power struggle, lack of respect, poverty to mention a few, which supports previous studies findings [1]. These views are slightly different from another quantitative study, which showed that healthcare workers agree to differing aetiologic factors of conflicts. The causes among them were hegemony, poor interpersonal communication, inadequate opportunities for staff interaction, sexual harassment, stress, personality differences, dysfunctional teams, favouritism, warring egos, heavy workloads, and poor job descriptions.

It is vital to maintain a healthy work environment through proper conflict resolution [1, 13]. Conflict resolution is essential to avoid breakdown of the teams, especially management teams in healthcare and promote peace and harmony among workers. It is crucial to maintain a healthy work environment through proper conflict resolution [1, 13].

It is imperative for the managers in the Nigerian Health system while realizing that conflicts are unavoidable since there is regular human interaction in the clinical workplace; to institute institutional conflict resolution mechanism. Furthermore, sufficient conflict resolution may help to prevent the attrition of the insufficient health workforce in Nigeria [23, 24].

Strategies that can be used to minimize conflict are attractive remuneration, professional laws, mutual respect, among others. Majority of these solutions focus on what can only be resolved at the managerial level.

It is, therefore, necessary for hospital administrators and the Government; who are the major employers of doctors in Nigeria to consider conflict management by strategically imbibing a proactive mindset in addressing conflict and its impact in the Nigeria health sector [25].

There is a need to conduct In-depth Interviews (IDI) on how healthcare professionals cope with conflicts within their collaboration as most physicians choose between ignoring the conflict and/or engaging in it [6]. Moreover, this will help design effective conflict management strategies.

The study is limited because all respondents are from training centres in only two geo-political zones of Nigeria. However, the results of this study would make a valuable contribution to the knowledge of conflict and ECDs in Nigeria.

## Acknowledgements

The National Executive Council and Advisors of the Research & Statistics Committee (RSC)/Research Collaboration Network (RCN) of the Nigerian Association of Resident Doctors (NARD). Funding support from the Nigerian Association of Resident Doctors (NARD)

## Conflict of Interest Statement

All authors are ECDs except the third and last authors.

## References

1. Ojo EO, Chirdan OO, Ajape AA, Agbo S, Oguntola AS, Adejumo AA, et al. Post-graduate surgical training in Nigeria: The trainees' perspective. *Niger Med J*. 2014;55(4):342–7. <https://doi.org/10.4103/0300-1652.137227>
2. Saltman DC, O'Dea NA, Kidd MR. Conflict management: a primer for doctors in training. *Postgrad Med J*. 2006;82(963):9–12. <https://doi.org/10.1136/pgmj.2005.034306>
3. Adebayo O, Akande T, Buowari DY, Ogunsuji O, Yussuf TM.

- Managing Conflicts at Workplace: Guide for Early Career Doctors. Adebayo O, Olaopa O, editors. [Internet]. Abuja: National Association of Resident Doctors of Nigeria (NARD); 2019 [cited 2020 Jun 28]. Available from: [https://www.academia.edu/40640463/Managing\\_Conflicts\\_at\\_the\\_Workplace\\_Guide\\_for\\_Early\\_Career\\_Doctors](https://www.academia.edu/40640463/Managing_Conflicts_at_the_Workplace_Guide_for_Early_Career_Doctors)
4. Porter-O'Grady T. Embracing conflict: building a healthy community. *Health Care Manage Rev.* 2004;29(3):181–7. <http://dx.doi.org/10.1097/00004010-200407000-00003>
  5. Adebayo O, Oluwaseyi O, Olaopa O, Kpuduwei S, Oluwafemi E, Omotayo FF, et al. Trainees collaboratively investigating early career doctors' themes: a NARD initiative in Nigeria. *Niger J Med.* 2019;28(1):93–7.
  6. Kanmodi K, Ekundayo O, Adebayo O, Efuntoye O, Ogunsuji O, Ibiyo M, et al. Challenges of residency training and early career doctors in Nigeria study (CHARTING STUDY): a protocol paper. *Niger J Med.* 2019;28(2):198–205.
  7. NARD. Initiating Trainee Research Collaboration Network: A NARD Initiative in Nigeria [Internet]. Abuja: National Association of Resident Doctors of Nigeria (NARD); 2019 [cited 2020 Jun 23]. Available from: <https://drive.google.com/file/d/1Xvy4pDrWpXHGvE36oKheKOVKEOVgagLY/view>
  8. Adebayo O, Fagbule OF, Omololu A, Ibrahim YA, Isibor E, Olaopa O, et al. We are Early Career Doctors We are NARD [Internet]. Abuja: National Association of Resident Doctors of Nigeria; 2019 [cited 2020 Jun 23]. Available from: [https://www.researchgate.net/publication/335990507\\_We\\_are\\_Early\\_Career\\_Doctors\\_We\\_are\\_NARD](https://www.researchgate.net/publication/335990507_We_are_Early_Career_Doctors_We_are_NARD)
  9. Ulin PR, Robinson ET, Tolley EE. *Qualitative methods in public health: A field guide for applied research* [Internet]. San Francisco: John Wiley & Sons; 2005. [cited 2020 Jun 23]. Available from: [https://alraziuni.edu.ye/book1/nursing/ebooksclub.org\\_\\_Qualitative\\_Methods\\_in\\_Public\\_Health\\_\\_A\\_Field\\_Guide\\_for\\_Applied\\_Research.pdf](https://alraziuni.edu.ye/book1/nursing/ebooksclub.org__Qualitative_Methods_in_Public_Health__A_Field_Guide_for_Applied_Research.pdf)
  10. Adebayo O, Kanmodi K, Olaopa O, Fagbule OF, Adufe I, Adebayo AM, et al. Strategies for mitigating burnout among early career doctors in Nigeria: lessons learnt from the qualitative CHARTING study. *Global Psychiatry.* 2020;3(1):97–103. <http://dx.doi.org/10.2478/gp-2020-0005>
  11. Isibor E, Kanmodi K, Adebayo O, Olaopa O, Igbokwe M, Adufe I, et al. Exploring Issues and Challenges of Leadership among Early Career Doctors in Nigeria Using a Mixed-Method Approach: CHARTING Study. *Eur J Investig Health Psychol Educ.* 2020;10(1):441–54. <https://doi.org/10.3390/ejihpe10010033>
  12. Greenfield LJ. Doctors and nurses: a troubled partnership. *Ann Surg.* 1999;230(3):279–88. <https://doi.org/10.1097/00000658-199909000-00001>
  13. Olajide AT, Asuzu MC, Obembe TA. Doctor-nurse conflict in Nigerian hospitals: Causes and modes of expression. *Br J Med Med Res.* 2015;9(10):1–12. <https://doi.org/10.9734/bjmmr/2015/15839>
  14. Osakede KO, Ijimakinwa SA. The effect of public sector health care workers strike: Nigeria experience. *Review Pub Administration Manag.* 2014;3(6):154–161.
  15. Okhakhu EE, Okhakhu AL, Okhakhu JOO. Managing organizational conflicts: A phenomenological Study of Nurse/Physician conflicts in Nigerian hospitals and their impact on managed care delivery. *J Entrep Organiz Manag.* 2014;3(2):1000115. <https://doi.org/10.4172/2169-026x.1000115>
  16. Ogbimi RI, Adebamowo CA. Questionnaire survey of working relationships between nurses and doctors in University Teaching Hospitals in Southern Nigeria. *BMC Nurs.* 2006;5(1):2. <http://dx.doi.org/10.1186/1472-6955-5-2>
  17. Ogbonnaya LU, Ogbonnaya CE, Adeoye-Sunday IM. The perception of health professions on causes of interprofessional conflict in a tertiary health institution in Abakaliki, southeast Nigeria. *Niger J Med.* 2007;16(2):161–8. <https://doi.org/10.4314/njm.v16i2.37300>
  18. McMillan J, Anderson L. Knowledge and Power in the Clinical Setting. *Bioethics.* 1997;11(3–4):265–70. <https://doi.org/10.1111/1467-8519.00065>
  19. De Dreu CK, Weingart LR. Task versus relationship conflict, team performance, and team member satisfaction: A meta-analysis. *J Appl Psychol.* 2003;88(4):741–9. <https://doi.org/10.1037/0021-9010.88.4.741>
  20. Medina FJ, Munduate L, Dorado MA, Martínez I, Guerra JM. Types of intragroup conflict and affective reactions. *J Manage Psychol.* 2005;20(3/4):219–30. <https://doi.org/10.1108/02683940510589019>
  21. Alubo SO. The political economy of doctors' strikes in Nigeria: a Marxist interpretation. *Soc Sci Med.* 1986;22(4):467–77. [https://doi.org/10.1016/0277-9536\(86\)90051-1](https://doi.org/10.1016/0277-9536(86)90051-1)
  22. Adebayo O, Adufe I, Omololu A, Dabota YB, Egbu O, Isibor E, et al. White Coat Drain; A monograph on the migration of Nigerian Doctors [Internet]. Abuja: National Association of Resident Doctors of Nigeria (NARD); 2019. [cited 2020 Jun 23]. Available from: [https://www.researchgate.net/publication/336009712\\_White\\_Coat\\_Drain\\_A\\_monograph\\_on\\_the\\_migration\\_of\\_the\\_Nigerian\\_Doctors](https://www.researchgate.net/publication/336009712_White_Coat_Drain_A_monograph_on_the_migration_of_the_Nigerian_Doctors)
  23. Adebayo O, Labiran A, Emerenini CF, Omoruyi L. Health Workforce for 2016–2030: Will Nigeria have enough. *Inter J Inn Heal Res.* 2016;4(1):9–16.
  24. Timinepere CO, Agbaeze EK, Ogbo A, Nwadukwe UC. Organizational Justice and Turnover Intention among Medical and Non-Medical Workers in University Teaching Hospitals. *Mediterr J Soc Sci.* 2018;9(2):149–60. <https://doi.org/10.2478/mjss-2018-0035>
  25. Obembe TA, Olajide AT, Asuzu MC. Managerial dynamics influencing doctor–nurse conflicts in two Nigerian hospitals. *J Family Med Prim Care.* 2018;7(4):684–92. [https://doi.org/10.4103/jfmpc.jfmpc\\_353\\_17](https://doi.org/10.4103/jfmpc.jfmpc_353_17)

## Tables

**Table 1.** Participants' socio-demographic characteristics (N=14)

	<b>Variables</b>	<b>Ne</b>	<b>%</b>
A	<b>Status</b>		
	House officer	1	7.1
	Senior Medical Officer	1	7.1
	Registrar	4	28.6
	Senior Registrar	8	57.2
B	<b>Sex</b>		
	Male	12	85.7
	Female	2	14.3
C	<b>Zones</b>		
	South-west	8	57.1
	South-south	6	42.9
D	<b>Centre</b>		
	University College Hospital(UCH), Ibadan	2	14.3
	ObafemiAwolowo University Teaching Hospital Complex (OAUTHC)Ile-Ife	2	14.3
	Lagos University Teaching Hospital(LUTH)Lagos	2	14.3
	LAUTECH Teaching Hospital(LTH), Ogbomoso	2	14.3
	River State University Teaching Hospital (RSUTH), Port-Harcourt	2	14.3
	Federal Medical Centre (FMC), Yenegoa	3	21.4
Niger Delta University Teaching Hospital(NDUTH), Okolobiri	1	7.1	

# CHANGES IN COAGULATION PARAMETERS AFTER PERMANENT PACEMAKER IMPLANTATION

I.D. Yoncheva<sup>1</sup>, D.E. Biserov<sup>1</sup>, M.N. Negreva<sup>2</sup>

<sup>1</sup>University Hospital Virgin Mary, Burgas, Bulgaria

<sup>2</sup>University Hospital St. Marina, Varna, Bulgaria

## Abstract

The connection between venous thrombotic events in patients with implanted pacemakers and changes in coagulation factors has been the basis of numerous scientific studies for years. Results show that the effect on the coagulation system is a long-term and dynamic process, as well as presence of a significant dependence with many concomitant cardiovascular diseases.

Advances in medicine in recent decades and increase in life expectancy of patients with implanted cardiac devices (ICD) increase the risk of a variety of complications. These adverse events may be associated with development of thrombosis, change in the stimulation threshold, need for ablation due to concomitant rhythm pathology and others.

Analysis of data from literature shows unequivocally that placement of endocardial electrodes leads to activation of the coagulation system in the body. On the one hand, this is a result of the direct traumatic moment and endothelial damage in the early post-procedure period, and subsequently, the presence of electrodes of the foreign body type in some individuals can provoke a procoagulation state.

More in-depth research is needed in this area to clarify the answers to these questions, namely: in which phase of the coagulation cascade are the changes most significant; is there a way to anticipate these changes and prevent them accordingly; is disturbed homeostasis of coagulation temporary or persistent.

These questions will be answered after sufficient data have been accumulated on these changes and how to modulate them.

## Keywords

coagulation • cardiac devices • thrombosis • electrodes • endothelial damage

## Introduction

Blood clotting is the basis of the protection of organisms from fatal blood loss, but can also lead to thrombotic occlusion of a blood vessel, which in turn leads to development of pulmonary embolism, myocardial infarction, stroke and others.

There are currently a number of anticoagulants (heparin, vitamin K antagonists, direct thrombin inhibitors or anti-Xa agents) that are used to prevent and treat thromboembolic events. On the other hand, the widespread use of anticoagulants leads to a drastic increase in haemorrhagic accidents, some of which are fatal.

Fibrin formation is the basis of thrombosis, and this process can be initiated in two ways: participation of tissue factor (TF) or activation of factor XII. The so-called “intrinsic pathway” of coagulation is triggered by contact of factor XII with a surface, foreign to the bloodstream, which leads to formation of active serine protease FXIIa. This in turn causes activation of FXI,

kallikrein-kinin system, as well as a subsequent cascade of proteolytic processes, and as a final result to thrombus formation [1].

In recent years, a lot of data has been accumulated from studies that prove the link between implantable ICD and development of chronic thromboembolic pulmonary hypertension (CTEPH). These results have led the scientific community to conduct in-depth studies of the haemostatic changes that occur in this group of patients.

The association between venous thrombotic events in patients with implanted pacemakers and changes in coagulation factors, inflammatory response markers, and some echocardiographic parameters was studied by the team of Lelakowski J. Cracow [2]. They monitored 81 patients with implanted pacemakers (30 women, 51 men, mean age: 71.1±7.4 yr.) and divided them into two groups: group A - no

established venous thrombosis (28 women, 43 man; mean age:  $71.2 \pm 7.6$  yr.), and group B - with established thrombosis (2 women, 8 man; mean age:  $72.6 \pm 7.2$  g). Patients were monitored for 18 months. 32 patients from group A and 3 patients from group B were excluded during follow-up due to initiation of anticoagulant therapy. At 12 months, 39 patients in group A and 7 patients in group B were available. All patients underwent echocardiography, examining the left ventricular ejection fraction (LVEF) with the Simpson's method, early rate of propagation of diastolic mitral blood flow ( $V_p$ ), end-distal LV size from parasternal access along M-mode long axis (LVEDD). Assessment of the venous system of the upper extremities was performed with pulse Doppler. Ultrasound assessment of the heart and venous system was performed before pacemaker implantation, both at 6 and 12 months thereafter. Blood samples were taken before implantation and 7 days later. D-dimer, fibrinogen, plasminogen activator inhibitor (PAI-1), tissue factor (TF), factor VII, C reactive protein (hsCRP) and interleukin 6 (IL-6) were tested after 6 and 12 months.

Analysis of echocardiography results showed that patients in group B had significantly lower EF, larger diastolic LV diameter and evidence of diastolic dysfunction compared to patients in group A.

Baseline plasma levels of prothrombotic (D-dimer, fibrinogen, TF, FVII, PAI-1) and proinflammatory (IL-6, hsCRP) markers were significantly higher in group B than in group A. In all patients, levels of the studied indicators continued to increase up to 7 days after pacemaker implantation. At follow-up visits at 6 and 12 months after the procedure, the trend of increase of the studied indicators was maintained in group B, while the levels in group A patients normalised. It is interesting to note that the degree of increase in the levels of the studied indicators was most significant from 6 to 12 months after implantation. This means that the effect on the coagulation system is a long-term and dynamic process, as well as that there is a presence of a connection with many concomitant diseases [3]. In order to establish the intimate mechanism of the changes, it is necessary to follow the patients for a longer period of time. There is also evidence that the FVIIa-AT complex can be used as a new biomarker for coagulation activation [4].

Epidemiological and clinical data indicate a connection between biochemical markers of endothelial damage and platelet activation and development of venous thrombosis, which is consistent with data from this study [5]. Pathological activation of coagulation and decreased fibrinolytic activity lead to venous thrombosis and obstruction, which can trigger pulmonary thromboembolism. This study confirmed the hypothesis that levels of prothrombotic and proinflammatory markers of endothelial damage were significantly elevated in patients with implanted pacemakers and evidence of

thrombosis, both before implantation and during follow-up period. A disadvantage of the study is the small group of monitored patients, as well as lack of a control group without an ICD.

The effect of PPM on vascular endothelium, coagulation cascade, and cardiac pump function was the basis of a study published by Zhang et al. in 2018 [6]. They examined 53 healthy controls, 59 patients with ICD and 58 patients with bradycardia without ICD. Blood samples were taken before implantation and on day 7 after implantation, both in patients without ICD and controls.

Following indicators were studied: prothrombin time (PT), factor VIII, von Willebrand factor (vWF), fibrinogen (FIB), D-dimer (DD), thrombomodulin (TM), tissue factor (TF), antithrombin activity (AT:A), plasminogen activity (PLG:A), and left ventricular systolic function assessed by ECG.

The coagulation system is in direct contact with vascular endothelial cells, which secrete a number of biologically active molecules after suffering endogenous or exogenous damage [7]. Thrombomodulin is a protein secreted by endothelial cells, which increases in endothelial damage, leading to activation of von Willebrand factor (vWF) secretion as well as increased plasma factor (TF) levels. Therefore, these markers were used to assess endothelial cell damage.

Plasma antithrombin activity indicates how much thrombin is produced in the body, and elevated vWF levels lead to activation of FVIII secretion. An increase in these parameters indicates that the coagulation system is activated. Plasminogen is a single-chain glycoprotein that is transformed to plasmin upon endothelial damage. Plasmin lyses the formed fibrin, which leads to increased D-dimer plasma levels, which in turn is a trigger to activate coagulation [8]. Thus, fibrinolytic activity was assessed in the studied patients. Results of this study showed significantly higher values of FVIII: C, vWF, D-D, TM, TF and LKTDO in the bradycardia group compared to the control group. There was also a significant increase in FVIII values: C, vWF, D-D, TM, TF and LVTDV in patients after pacemaker implantation compared to those studied before implantation. These results confirm the effect of implantable cardiac devices on patients' coagulation system. Disturbance in homeostasis of coagulation and fibrinolysis, possibly mediated by endothelial damage, was also been reported in patients with bradycardia who had no ICD. This in turn demonstrates the benefit of improving hemodynamic parameters after normalization of heart rate through cardiostimulation and the overall positive effect on quality of life and long-term prognosis in patients with bradycardia.

Changes in the coagulation system as well as fibrinolytic activity in patients with placed endocardial electrodes were studied by T. Yaegashi et al. [9]. They looked for difference in the response of the coagulation system after implantation of high-voltage and low-voltage electrodes in the early post-

procedure period. Follow-up also included patients after reimplantation of the pulse generator only. Analysis of results showed that the studied factors had a similar rise curve in the group with placed electrodes, regardless of low or high voltage. It is interesting to note that in patients in which only the pulse generator was replaced and no electrodes were placed, there was no similar change in levels of studied coagulation factors. This study raises the question of the influence of endocardial electrodes on coagulation and presence of individual differences in the reaction to thrombosis and fibrinolysis in patients with pacemakers.

Modern treatment of many cardiovascular diseases includes not only various implantable devices, but also valve prostheses, stents, endovascular grafts, as well as venous catheters for chemotherapy and central infusion lines for medication and monitoring of critically ill patients. Thrombotic mass formation on these devices and implants is the most common cause of their impaired function and unfavourable therapeutic outcome. Jaffer et al. published an analysis of thrombosis pathogenesis on medical implants and devices, focusing on the intrinsic pathway of activation of the coagulation cascade [10].

Unlike intact endothelium, which actively prevents thrombosis, foreign surface contact initiates coagulation with sequentially activated processes of protein deposition, platelet adhesion, followed by leukocytes and erythrocytes deposition, thrombin generation and complement system activation.

It is well known that implanted materials are extremely quickly covered by a layer of protein molecules from bloodstream and intercellular space [11]. This suggests that the initial cellular response is to this protein layer and not the foreign surface itself. Independent studies of the effect of various foreign surfaces demonstrate the leading role of extracellular adhesion molecules - fibronectin and vitronectin.

Dynamic protein deposition is related to physicochemical properties of the foreign surface and protein molecules, this process being reversible. It has been shown that the composition of protein molecules changes over time, a phenomenon known as the Vroman effect. Hydrophilicity is a key determinant in protein adsorption, as more protein molecules adhere to hydrophobic surfaces. In addition, the foreign surface can lead to structural changes in protein molecules, which can change their biological activity [12].

Fibrinogen is the first plasma protein to be deposited on foreign surface, followed by fibronectin and von Willebrand factor, together leading to platelet activation. Deposited fibrinogen is soon replaced by components of the contact system: factor XII, high molecular mass quinogen, prekallikrein and factor XI. Activated factor XII not only triggers thrombin synthesis through the intrinsic coagulation pathway, but also activates the complement system.

Adherent activated platelets begin to secrete thromboxane A<sub>2</sub>, ADP, and other agonists, and also mediate leukocyte

adhesion by P-selectin [13]. In turn, leukocytes produce free radicals, but can also degranulate and release substances such as platelet activating factor, interleukins, tumour necrosis factor, which leads to release of tissue factor from attracted monocytes.

Activated factor XII activates prekallikrein and factor XI, which in turn initiate a series of proteolytic reactions and lead to thrombin synthesis. Thrombin not only converts fibrinogen into fibrin monomers, but is also a potent platelet agonist. Fibrin monomers polymerize to fibrin, which stabilizes platelet aggregates into thrombi. These thrombotic deposits can lead to device or catheter dysfunction and compromise their function. On the other hand, particles from these blood clots can separate and with circulation to compromise the blood supply to important organs.

Yau et al. investigated the role of the intrinsic activation pathway in the process of thrombosis in contact with medical catheters and devices [14, 15]. They found that plasma thrombin time was three times shorter in the presence of catheter fragments than when they were absent. Prothrombotic activity of catheter fragments is mediated by the intrinsic pathway of activation. This is proved by the fact that it is blocked by the corn trypsin inhibitor (CTI), a potent and specific inhibitor of factor XII [16]. Also, the procoagulant effect of catheter fragments is almost absent in plasma devoid of factor XII and factor XI.

Recent studies have shown that formation of thrombotic masses in an extracorporeal circulatory system and vascular grafts is also mediated by the intrinsic pathway of coagulation activation. Larsson et al. conducted an experimental study with rabbits. They found that a specific factor XII-blocking antibody (3F7) resulted in thrombotic protection comparable to that of heparin using ECMO (extracorporeal membrane oxygenation system). On the other hand, administration of 3F7 did not affect plasma haemostatic parameters and did not lead to increased bleeding, as with heparin [17, 18]. Similar results were obtained as well in antibody-mediated blockade of factor XI in primates [19, 20]. The study showed a persistent antithrombotic effect without increasing the risk of bleeding.

Efforts to prevent thrombosis on surfaces of medical implants and devices are aimed at developing surfaces with less thrombogenicity. As mentioned earlier, the adsorption of protein molecules on a foreign surface is the initiating step in thrombosis. The approach to find a material resistant to protein adsorption is guided by the fact that protein molecules are attracted by electrostatic and hydrophobic interactions on the surface of the foreign body.

Over the years, numerous studies of artificial and biomaterials have been conducted to reduce this interaction. Endocardial pacing electrodes, in addition to being low in thrombogenicity, must meet a number of other requirements. The external insulation of the electrodes must be resistant to blood flow in the venous circulation system, withstand heart



valve friction, friction between two adjacent electrodes, as well as constant movement and strain from the contraction of the heart muscle. Advantages and disadvantages of polyurethane and silicone rubber used to insulate electrodes have been debated for years [21]. Not to be overlooked is surgeon's preference, which depends on the convenience of the material during implantation. This puts requirements for sustainability, security, mass production capability and price before engineers. Regarding the effect on coagulation, polyurethane-coated electrodes are less prothrombogenic than silicone-coated electrodes. Introduction of new therapeutic methods in electrophysiology places requirements on endocardial electrodes for resistance to temperature influences. On the other hand, violation of the integrity of the insulation changes the prothrombogenic characteristics of the material.

Advances in medicine in recent decades and increase in life expectancy of patients with implanted cardiac devices (ICD) increase the risk of a variety of complications. These adverse events may be associated with development of thrombosis, change in the stimulation threshold, need for ablation due to concomitant rhythm pathology and others.

## Conclusion

Analysis of data from literature shows unequivocally that placement of endocardial electrodes leads to activation of the coagulation system in the body. On the one hand, this is a result of the direct traumatic moment and endothelial damage

in the early post-procedure period, and subsequently, the presence of electrodes of the foreign body type in some individuals can provoke a procoagulation state. In the body, coagulation and fibrinolysis are in constant balance and active mutual regulation, ensuring normal functioning of the healthy individual. There is a violation of this balance in patients with indications for cardiostimulation and implantation of the device aims to normalize hemodynamic parameters. Any condition, uncharacteristic for the body, such as placement of endocardial electrodes, pro-inflammatory response to endothelial damage, and asynchronous ventricular contraction by the artificial heart rate regulator, has unpredictable effects on homeostasis.

More in-depth research is needed in this area to clarify the answers to these questions, namely: in which phase of the coagulation cascade are the changes most significant; is there a way to anticipate these changes and prevent them accordingly; is disturbed homeostasis of coagulation temporary or persistent. This requires the study of coagulation factors involved in the various phases of the thrombotic and thrombolytic cascade, as well as monitoring the dynamics of these parameters for a longer period of time.

These questions will be answered after sufficient data have been accumulated on these changes and how to modulate them.

## Conflict of Interest Statement

There is no conflict of interest to declare.

## References

1. Nayak R, Fernandes TM, Auger WR, Pretorius GV, Madani MM, Birgersdotter-Green UM. Contribution of Cardiac Implantable Electronic Devices to Thrombus Formation in Patients With Chronic Thromboembolic Pulmonary Hypertension. *JACC Clin Electrophysiol.* 2018;4(11):1431-36. <https://doi.org/10.1016/j.jacep.2018.08.013>
2. Lelakowski J, Domagała TB, Rydlewska A, Januszek R, Kotula-Horowitz K, Majewski J, et al. Relationship between changes in selected thrombotic and inflammatory factors, echocardiographic parameters and the incidence of venous thrombosis after pacemaker implantation based on our own observations. *Arch Med Sci.* 2012;8(6):1027-34. <https://doi.org/10.5114/aoms.2012.28600>
3. Zabczyk M, Butenas S, Palka I, Nessler J, Undas A. Active tissue factor and activated factor XI in circulating blood of patients with systolic heart failure due to ischemic cardiomyopathy. *Pol Arch Med Wewn.* 2010;120(9):334-40.
4. Spiezia L, Campello E, Valle FD, Woodhams B, Simioni P. Factor VIIa-antithrombin complex: a possible new biomarker for activated coagulation. *Clin Chem Lab Med.* 2017;55(4):484-88. <https://doi.org/10.1515/cclm-2016-0399>
5. Iskra T, Turaj W, Słowik A, Zwolińska G, Strojny J, Szczudlik A. Hemostatic markers of endothelial injury in ischaemic stroke caused by large or small vessel disease. *Pol Merkur Lekarski.* 2006;21(125):429-33. Polish.
6. Zhang X, Li Y, Wang N, Zhang C, Zhang D, Li Q. Effects of permanent cardiac pacemaker implantation on vascular endothelial function, blood coagulation and cardiac function in patients with bradycardia. *Exp Ther Med.* 2018;16(6):4717-21. <https://doi.org/10.3892/etm.2018.6808>

7. Madershahian N, Scherner M, Weber C, Kuhn E, Choi YH, Slottosch I, et al. Temporary biventricular pacing improves bypass graft flows in coronary artery bypass graft patients with permanent atrial fibrillation. *Interact Cardiovasc Thorac Surg*. 2015;21(4):435-40. <https://doi.org/10.1093/icvts/ivv169>
8. Olson NC, Raffield LM, Lange LA, Lange EM, Longstreth WT Jr, Chauhan G, et al. Associations of activated coagulation factor VII and factor VIIa-antithrombin levels with genome-wide polymorphisms and cardiovascular disease risk. *J Thromb Haemost*. 2018;16(1):19-30. <https://doi.org/10.1111/jth.13899>
9. Yaegashi T, Furusho H, Kato T, Chikata A, Takashima S, Usui S, et al. Systemic excess of coagulation systems after implanting device leads for low voltage devices as well as high voltage devices. *Europace*. 2011;13 Suppl 3. <https://doi.org/10.1093/europace/eur229>
10. Jaffer IH, Fredenburgh JC, Hirsh J, Weitz JI. Medical device-induced thrombosis: what causes it and how can we prevent it? *J Thromb Haemost*. 2015;13 Suppl 1:S72-81. <https://doi.org/10.1111/jth.12961>
11. Wilson CJ, Clegg RE, Leavesley DI, Percy MJ. Mediation of biomaterial-cell interactions by adsorbed proteins: a review. *Tissue Eng*. 2005;11(1-2):1-18. <https://doi.org/10.1089/ten.2005.11.1>
12. Turbill P, Beugeling T, Poot AA. Proteins involved in the Vroman effect during exposure of human blood plasma to glass and polyethylene. *Biomaterials*. 1996;17(13):1279-87.
13. Kazatchkine MD, Carreno MP. Activation of the complement system at the interface between blood and artificial surfaces. *Biomaterials*. 1988;9(1):30-5. [https://doi.org/10.1016/0142-9612\(88\)90066-X](https://doi.org/10.1016/0142-9612(88)90066-X)
14. Yau JW, Stafford AR, Liao P, Fredenburgh JC, Roberts R, Weitz JI. Mechanism of catheter thrombosis: comparison of the antithrombotic activities of fondaparinux, enoxaparin, and heparin in vitro and in vivo. *Blood*. 2011;118(25):6667-74. <https://doi.org/10.1182/blood-2011-07-364141>
15. Steg PG, Jolly SS, Mehta SR, Afzal R, Xavier D, Rupprecht HJ, et al. Low-dose vs standard-dose unfractionated heparin for percutaneous coronary intervention in acute coronary syndromes treated with fondaparinux: the FUTURA/OASIS-8 randomized trial. *JAMA*. 2010;304(12):1339-49. <https://doi.org/10.1001/jama.2010.1320>
16. Yau JW, Stafford AR, Liao P, Fredenburgh JC, Roberts R, Brash JL, et al. Corn trypsin inhibitor coating attenuates the prothrombotic properties of catheters in vitro and in vivo. *Acta Biomater*. 2012;8(11):4092-100. <https://doi.org/10.1016/j.actbio.2012.07.019>
17. Larsson M, Rayzman V, Nolte MW, Nickel KF, Björkqvist J, Jäm-så A, et al. A factor XIIa inhibitory antibody provides thromboprotection in extracorporeal circulation without increasing bleeding risk. *Sci Transl Med*. 2014;6(222):222ra17.
18. Majeed A, Schulman S. Bleeding and antidotes in new oral anticoagulants. *Best Pract Res Clin Haematol*. 2013;26(2):191-202. <https://doi.org/10.1016/j.beha.2013.07.001>
19. Crosby JR, Marzec U, Revenko AS, Zhao C, Gao D, Matafonov A, et al. Antithrombotic effect of antisense factor XI oligonucleotide treatment in primates. *Arterioscler Thromb Vasc Biol*. 2013;33(7):1670-8. <https://doi.org/10.1161/ATVBAHA.113.301282>
20. Salomon O, Steinberg DM, Zucker M, Varon D, Zivelin A, Seligsohn U. Patients with severe factor XI deficiency have a reduced incidence of deep-vein thrombosis. *Thromb Haemost*. 2011;105(2):269-73. <https://doi.org/10.1160/th10-05-0307>
21. Cuvillier E. *Handbook of Leads for Pacing, Defibrillation and Cardiac Resynchronization*. Santo Domingo: Editora Corripio; 2016. p. 67-90.

# PULMONARY HYPERTENSION IN PATIENTS AFTER PERMANENT PACEMAKER IMPLANTATION

I.D. Yoncheva<sup>1</sup>, D.E. Biserov<sup>1</sup>, M.N. Negreva<sup>2</sup>

<sup>1</sup>University Hospital Virgin Mary, Burgas, Bulgaria

<sup>2</sup>University Hospital St. Marina, Varna, Bulgaria

## Abstract

Permanent pacemaker (PPM) implantation can lead to thromboembolic events at different times after the procedure. According to literature, 1.7% of patients with pulmonary embolism have an implantable cardiac device. This frequency is higher than reported so far, from 0.16 to 0.47% of the total population.

The pathophysiologic mechanism of pulmonary embolism in chronic thromboembolic pulmonary hypertension (CTEPH) is multifactorial. Recently, there is evidence that not only the organisation of thrombotic deposits in the proximal pulmonary arterial vessels is important, but also the development of small vessel disease, which plays an important role in the evolution and progression of the disease. The role of thrombosis in medical devices in contact with blood flow, such as stents, vascular grafts, heart valves, has been well studied and documented in scientific literature on biomaterials. It is clear that implantable cardiac devices such as pacemakers, similarly to other foreign surfaces exposed to blood flow, promote blood clotting and complement activation. Numerous studies to date have addressed the potential risk of distal vascular involvement of pulmonary circulation in the presence of a pacemaker, but none has conclusively proven this hypothesis.

Over the last decade, there has been significant progress in the therapeutic potential of CTEPH. Pulmonary endarterectomy remains the only therapeutic method that can lead to lasting clinical improvement in these patients while achieving a good quality of life. This method is operational, with high financial value and is associated with the presence of a highly specialised team of specialists. This justifies the search for ways to prevent the onset of the disease rather than treat the consequences.

## Keywords

*pulmonary embolism • pacemaker electrodes • thromboembolism • endarterectomy • small vessel disease*

## Introduction

In modern cardiology, the treatment of a wide range of diseases is carried out by implantation of various electronic devices, from the conventional pacemaker for bradycardia, resynchronisation therapy in left bundle branch block and left ventricular dysfunction, implantable cardioverter-defibrillator (ICD) for primary and secondary prevention of sudden cardiac death (SCD), to experimental devices for monitoring vascular pressures, new methods for treating heart failure and modulating sympathetic activity. According to data from registers for implanted cardiac devices in European countries, we can see that with the increase in life expectancy, increases the number of implanted devices per million people [1]. More than 500 000 devices are implanted worldwide each year. Therefore, precision in the clinical approach to pacemaker patients is becoming increasingly important.

PPM implantation can lead to thromboembolic events at different times after the procedure. On the one hand, endothelial trauma in vascular access can provoke early or late venous thrombosis, and on the other hand, the presence of endocardial electrodes can initiate formation of microthrombi, leading to embolisms in the pulmonary vascular bed. According to protocols from pathoanatomical studies, thromboembolic complications (mainly asymptomatic pulmonary thromboembolism and electrode-associated thrombi) found in PPM patients are much more common than clinically established [2, 3].

The recently growing interest in the study and treatment of pulmonary vascular disease has led to increased research and improved diagnosis of patients with chronic thromboembolic pulmonary hypertension (CTEPH) [4].

CTEPH is defined if after 3 months of adequate anticoagulant treatment the following is established:

1. Mean pulmonary arterial pressure >25 mmHg in pulmonary capillary pressure <15 mmHg;
2. Pulmoangiography data for reduced perfusion of one or more segments of the lung.

The number of patients with CTEPH is unclear. Until recently, it was defined by patients who experienced pulmonary embolism, in which the criteria for this diagnosis were established with a frequency of 0.1 to 5.1% in the course of follow-up.

CTEPH is a result of a single or recurrent pulmonary thromboembolism followed by incomplete thrombi resolution with subsequently developing fibrous organisation and remodelling of affected arteries and increased pulmonary artery resistance, progressive right ventricular failure and fatal outcome. Only 66% of patients with CTEPH have evidence of previous pulmonary thromboembolism, and for the rest, the cause is another pathophysiological process. Recurrent thromboembolism is also more common in men, while both sexes are equally affected by CTEPH, which means that pathogenesis here deviates from the classical pathway of thrombosis and thrombolysis [5, 6].

The discovery of clinical risk factors for CTEPH has shed light on new molecular mechanisms for the formation of thrombotic formations, their persistence in the vascular lumen and their fibrous transformation.

The pathophysiological mechanism of pulmonary hypertension in CTEPH is multifactorial. Recently, there is evidence that it is important not only to organise thrombotic deposits in the proximal pulmonary arteries, but also the development of small vessel disease, which plays an important role in the evolution and progression of the disease.

Risk factors for PE-associated CTEPH include: idiopathic form of embolism, recurrent episodes of embolism, a large perfusion defect, younger age, and mean pulmonary pressure above 50 mmHg at diagnosis [7, 8]. Some laboratory parameters are found in higher concentrations in CTEPH patients, such as factor VIII, lupus anticoagulant (LA), antiphospholipid antibodies, (APA) von Willebrand factor (vWF), plasminogen activator inhibitor type 1 (PAI-1) and fibrinogen.

A team of researchers from Bratislava, Bohacekova et al., analysed 81 patients (30 male and 51 female) with CTEPH, confirmed by cardiac catheterisation, half of them undergoing surgical treatment (endarterectomy) [9, 10]. All patients were screened for concomitant pathology. The team focused on the known established risk factors for CTEPH: idiopathic and recurrent PE, DVT, neoplastic disease, chronic inflammatory condition, presence of pacemaker electrodes, thyroid pathology, splenectomy, autoimmune disease, blood type other than 0. In both patients and controls, detailed studies of coagulation parameters, platelet aggregation (spontaneous

aggregometry), serum Von Willebrand factor (vWF) and PAI-1 levels were performed to assess endothelial damage. Results showed that in 79% of cases there was previous PE, in 59.3% a known DVT, and in 19.8% an idiopathic PE. In addition, 19% had history of thyroid pathology, 71% had blood type other than 0, 6.2% had inflammatory bowel disease, and 2.5% had a pacemaker or splenectomy. From haematological risk factors, spontaneous platelet aggregation (SPA) was found to be significantly higher in the CTEPH group ( $10.9 \pm 4.3\%$  vs.  $8.4 \pm 6.2\%$ ), as well as vWF activity, fibrinogen and FVIII levels, but not significantly.

The results from this study show the importance of SPA and the change in haemostatic parameters in the development of CTEPH, as well as the need for additional studies.

## Discussion

The discovery of the pathogenetic mechanisms and differentiation of high-risk CTEPH patients is the basis of many studies in this area. An analysis by Bonderman et al. of European CTEPH Registry data included 687 patients [11]. The study was retrospective and conducted in three major European Cardiovascular Research Centres: Medical University of Vienna (359 patients), Medical University of Prague (95 patients), Medical University of Homburg (233 patients). Results confirm the currently accepted risk factors, more commonly associated with CTEPH, such as infected pacemaker electrode, splenectomy, previous venous thrombosis, blood type other than 0, lupus anticoagulant and antiphospholipid antibodies. Thyroid pathology from replacement therapy and neoplastic disease are highlighted as additional risk factors.

Recent data from Rohith Nayak in JACC 2018 [12] show a clear link between CTEPH and implantable cardiac devices (ICD). CTEPH is a potentially treatable disease through pulmonary endarterectomy. They studied 982 CTEPH patients referred for this type of surgical treatment for the period January 2009 - December 2015 at the University of California, San Diego (UCSD). Results showed that 14 patients had implanted PPM before surgery and 3 had ICD (1.7% of the total).

It was found that 12 out of 17 (70.6%) patients with PPM had distal vascular disease compared to 241 out of 933 (25.8%) patients without ICD ( $p = 0.0002$ ). Venous thromboembolism was present in 50% of the PPM group and in 78.6% of non-PPM patients.

The established 1.7% incidence of pulmonary embolism in patients with ICD was higher than previously reported – 0.16-0.47% in the general population. Moreover, there was a prevalence of small vessel involvement and low association with previous venous thromboembolism. This suggests that

ICD electrodes can be a source of microthrombi that embolise distally and compromise pulmonary vascular circulation.

This thesis is supported by data from the cardiovascular surgery team at UCSD. Medani et al. analysed and published data from 1500 pulmonary endarterectomies, performed in patients with symptomatic CTEPH for the period March 1999 – December 2010 [13, 14]. In those patients, pulmonary hypertension was associated with endocardial pacing electrodes and preoperative pulmonary angiography showed minimal peripheral thromboembolic involvement. However, intraoperatively, they established more severe involvement of peripheral vessels, which after endarterectomy led to normalisation of haemodynamic parameters.

The role of thrombosis in medical devices in contact with blood flow, such as stents, vascular grafts, heart valves, has been well studied and documented in scientific literature on biomaterials. It is clear that implantable cardiac devices such as pacemakers, similarly to other foreign surfaces exposed to blood flow, promote blood clotting and complement activation [15].

A population-based study by Pederson et al. found a 0.3% risk of venous thromboembolism at 3 months and a 1.9% risk at 5 years after ICD implantation [16, 17]. There is also abundant data on the study of endocardial electrodes and formation of thrombotic masses on their surface [18]. In a retrospective study by Supple et al. in patients with ICD who underwent intracardiac echocardiography in preparation for an ablation procedure, thrombosis was found in 30% of cases [19]. A similar incidence of intracardiac electrode thrombosis was also demonstrated by Novak et al. in an autopsy study of patients with a pacemaker or ICD,  $n=90$  (33% in ventricular electrode and 48% in atrial electrode) [20]. Also in some cases there was simultaneous thrombosis, both intracardiacly and in the vein used for access. Based on this, they conclude that pulmonary thromboembolism was direct cause of death in 4 patients. Also, 8 patients were diagnosed with non-massive thromboembolism, and according to medical records during their lifetime, they were oligosymptomatic.

Numerous studies to date have addressed the potential risk of distal vascular involvement of pulmonary circulation in the presence of a pacemaker, but none has conclusively proven this hypothesis. Novak's analysis found that patients with CTEPH and a pacemaker were more often associated with distal vascular pathology. This suggests that electrodes may be a source of thrombi, which embolise in segmental and subsegmental branches of the pulmonary artery.

Organised thrombi in these small vessels are more difficult to remove in surgical endarterectomy and may even be referred to as inoperable in some centres [21].

According to UCSD data, despite their higher risk profile, patients with CTEPH and presence of cardiovascular implantable electronic device (CIED) had comparable

postoperative hemodynamic parameters and long-term prognosis to patients without a pacemaker. This shows that this group of affected individuals is indicated for surgery as well as explantation of the electronic device to avoid recurrence of symptoms [22, 23].

Development of risk scores and scales for predicting complications and selecting patients with indications for treatment is applied in a significant number of socially significant diseases. As early as 2001, the CHADS<sub>2</sub> score was introduced as a predictor of ischemic stroke in patients with non-valvular atrial fibrillation (AF). After analyses and studies, this score was extended to CHA<sub>2</sub>DS<sub>2</sub>-VASc, increasing the accuracy of predicting the risk of ischemic events and included in the recommendations of the European Society of Cardiology from 2016. There are also data from literature on the predictive value of CHA<sub>2</sub>DS<sub>2</sub>-VASc for cardiac events in patients without AF [24]. A 2015 study by Podolecki et al. showed an association between CHA<sub>2</sub>DS<sub>2</sub>-VASc and increased in-hospital mortality in patients with acute myocardial infarction. Melgaard et al. obtained similar results [25]. They found that higher CHA<sub>2</sub>DS<sub>2</sub>-VASc was associated with increased risk of IMI and death in chronic heart failure patients with or without AF [26].

Several mechanisms may explain the predictive role of CHA<sub>2</sub>DS<sub>2</sub>-VASc in adult patients. All risk factors are associated with increased incidence of ischemic brain events, both in AF and non-AF patients. Diabetes mellitus, hypertension and congestive heart failure are accompanied by endothelial dysfunction, increased thrombosis, increased levels of some adhesion molecules and oxidative stress. All of these lead to a prothrombotic state. On the other hand, as the number of risk factors increases, so does the number of ischemic events.

By analogy, a risk scale for patients with ICD can be developed, where the use of antithrombotic drugs could prevent deposition of thrombotic masses and their microembolisation in the pulmonary vascular bed. Differentiating this group will not be easy. On the one hand, the definite connection between the prothrombotic state, formation of microthrombi, their embolisation and development of CTEPH must be proved. On the other hand, AF incidence increases with age. Data from ICD are used to register these paroxysms, which is an indication for initiating anticoagulant therapy as a prophylaxis of thromboembolic events. The target population for the study should consist of patients with dual-chamber pacemaker with no evidence of AF paroxysms, and the presence or absence of risk factors for thrombotic events is debatable.

In a population-based study mentioned above, Pederson et al. [16] looked for a link between venous thromboembolism and concomitant pathology in patients with ICD/CRT-D. Comorbidity was determined, based on data from the Danish National Patient Registry, using the Charlson Comorbidity



Index (CCI) score, which has been validated as an adequate tool for assessing prognostic assessment in patients with ICD. Results showed a 2.7-fold higher incidence of venous thromboembolism in patients with severe comorbidity compared to those without concomitant pathology [27].

## Conclusion

The scientific community has the task to specify a risk scale for predicting those patients with implantable cardiac devices who would benefit from prophylactic treatment with an antithrombotic agent.

## References

1. Coma-Samartín R, Martínez-Ferrer J, Sancho-Tello de Caranza MJ, Ruiz-Mateas F, Leal Del Ojo-González J. Spanish Pacemaker Registry. Fourth Official Report of the Spanish Society of Cardiology Working Group on Cardiac Stimulation (2006). *Rev Esp Cardiol*. 2007;60(12):1302–1313. <https://doi.org/10.1157/13113936>
2. Ercan S, Altunbas G, Yavuz F, Bosnak V, Davutoglu V. Permanent pacemaker lead endocarditis due to *Staphylococcus hominis* and review of the literature. *Cor et Vasa*. 2012;54(9):e336–e338. <http://dx.doi.org/10.1016/j.crvasa.2012.07.001>
3. Edelstein S, Yahalom M. Cardiac device-related endocarditis: Epidemiology, pathogenesis, diagnosis and treatment - a review. *Int J Angiol*. 2009;18(4):167–172. <http://dx.doi.org/10.1055/s-0031-1278347>
4. Lang I. Advances in understanding the pathogenesis of chronic thromboembolic pulmonary hypertension. *Br J Haematol*. 2010;149(4):478–483. <https://doi.org/10.1111/j.1365-2141.2010.08142.x>
5. Bonderman D, Turecek PL, Jakowitsch J, Weltermann A, Adlbrecht C, Schneider B, et al. High prevalence of elevated clotting factor VIII in chronic thromboembolic pulmonary hypertension. *Thromb Haemost*. 2003;90(3):372–376. <https://doi.org/10.1160/th03-02-0067>
6. Kyrle PA, Minar E, Bialonczyk C, Hirschl M, Weltermann A, Eichinger S. The risk of recurrent venous thromboembolism in men and women. *N Engl J Med*. 2004;350:2558–2563. <https://doi.org/10.1056/nejmoa032959>
7. Yang S, Yang Y, Zhai Z, Kuang T, Gong J, Zhang S, et al. Incidence and risk factors of chronic thromboembolic pulmonary hypertension in patients after acute pulmonary embolism. *J Thorac Dis*. 2015;7(11):1927–1938. <https://doi.org/10.3978/j.issn.2072-1439.2015.11.43>
8. Guérin L, Couturaud F, Parent F, Revel MP, Gillaizeau F, Planquette B, et al. Prevalence of chronic thromboembolic pulmonary hypertension after acute pulmonary embolism. Prevalence of CTEPH after pulmonary embolism. *Thromb Haemost*. 2014;112(3):598–605. <https://dx.doi.org/10.1160/TH13-07-0538>
9. Bohacekova M, Kaldararova M, Valkovicova T, Remkova A, Vesely J, Simkova I. Risk factors detection in chronic thromboembolic pulmonary hypertension, a tool for risk quantification? *Bratisl Med J*. 2016;117(10):577–582.
10. Pepke-Zaba J, Delcroix M, Lang I, Mayer E, Jansa P, Ambroz D, et al. Chronic thromboembolic pulmonary hypertension (CTEPH): results from an international prospective registry. *Circulation*. 2011;124:1973–1981. <https://doi.org/10.1161/CIRCULATIONAHA.110.015008>
11. Bonderman D, Lang IM. Risk Factors for Chronic Thromboembolic Pulmonary Hypertension. Yuan JJ., Garcia J, West J, Hales C, Rich S, Archer S, editors. *Textbook of Pulmonary Vascular Disease*. Boston: Springer; 2011. p. 1253–1259. [https://doi.org/10.1007/978-0-387-87429-6\\_88](https://doi.org/10.1007/978-0-387-87429-6_88)
12. Nayak R, Fernandes TM, Auger WR, Pretorius GV, Madani MM, Birgersdotter-Green UM. Contribution of Cardiac Implantable Electronic Devices to Thrombus Formation in Patients With Chronic Thromboembolic Pulmonary Hypertension. *JACC Clin Electrophysiol*. 2018;4(11):1431–1436. <https://doi.org/10.1016/j.jacep.2018.08.013>
13. Madani MM, Auger WR, Pretorius V, Sakakibara N, Kerr KM, Kim NH, et al. Pulmonary endarterectomy: recent changes in a single institution's experience of more than 2,700 patients. *Ann Thorac Surg*. 2012;94(1):97–103. <https://doi.org/10.1016/j.athoracsur.2012.04.004>
14. Jamieson SW, Kapelanski DP, Sakakibara N, Manecke GR, Thistlethwaite PA, Kerr KM, et al. Pulmonary endarterectomy:

Over the last decade, there has been significant progress in the therapeutic potential of CTEPH. Pulmonary endarterectomy remains the only therapeutic method that can lead to lasting clinical improvement in these patients while achieving a good quality of life. This method is operational, with high financial value and is associated with the presence of a highly specialised team of specialists. This justifies the search for ways to prevent the onset of the disease rather than treat the consequences.

## Conflict of Interest Statement

No conflict of interest is declared.



- experience and lessons learned in 1,500 cases. *Ann Thorac Surg.* 2003;76(5):1457–1462. [https://doi.org/10.1016/S0003-4975\(03\)00828-2](https://doi.org/10.1016/S0003-4975(03)00828-2)
15. Jaffer IH, Fredenburgh JC, Hirsh J, Weitz JI. Medical device-induced thrombosis: what causes it and how can we prevent it? *J Thromb Haemost.* 2015;13 Suppl 1:S72–81. <https://doi.org/10.1111/jth.12961>
  16. Pedersen SB, Hjortshøj SP, Bøtker HE, Farkas DK, Schmidt M, Sørensen HT, et al. Venous thromboembolism in patients with implantable cardioverter-defibrillators. *Europace.* 2017;19(6):991–1001. <https://doi.org/10.1093/europace/euw124>
  17. Riva N, Donadini MP, Ageno W. Epidemiology and pathophysiology of venous thromboembolism: similarities with atherothrombosis and the role of inflammation. *Thromb Haemost.* 2015;113(6):1176–1183. <http://dx.doi.org/10.1160/TH14-06-0563>
  18. Korkeila P, Mustonen P, Koistinen J, Nyman K, Ylitalo A, Karjalainen P, et al. Clinical and laboratory risk factors of thrombotic complications after pacemaker implantation: a prospective study. *Europace.* 2010;12(6):817–824. <https://doi.org/10.1093/europace/euq075>
  19. Supple GE, Ren JF, Zado ES, Marchlinski FE. Mobile thrombus on device leads in patients undergoing ablation: identification, incidence, location, and association with increased pulmonary artery systolic pressure. *Circulation.* 2011;124(7):772–778. <https://doi.org/10.1161/CIRCULATIONAHA.111.028647>
  20. Novak M, Dvorak P, Kamaryt P, Slana B, Lipoldova J. Autopsy and clinical context in deceased patients with implanted pacemakers and defibrillators: intracardiac findings near their leads and electrodes. *Europace.* 2009;11(11):1510–1516. <https://doi.org/10.1093/europace/eup216>
  21. Novák M, Kamarýt P, Dvořák I, Mach P, Vykypěl T, Müllerová J. ICD lead-related complications. Mid-term follow-up of 172 patients with nonthoracotomy implantation. *Cor et Vasa.* 2004;46(7):311–318.
  22. Madani MM. Surgical Treatment of Chronic Thromboembolic Pulmonary Hypertension: Pulmonary Thromboendarterectomy. *Methodist Debaque Cardiovasc J.* 2016;12(4):213–218.
  23. Cannon JE, Su L, Kiely DG, Page K, Toshner M, Swietlik E, et al. Dynamic risk stratification of patient long-term outcome after pulmonary endarterectomy: results from the United Kingdom National Cohort. *Circulation.* 2016;133:1761–1771. <https://doi.org/10.1161/CIRCULATIONAHA.115.019470>
  24. Xing Y, Sun Y, Li H, Tang M, Huang W, Zhang K, et al. CHA2DS2-VASc score as a predictor of long-term cardiac outcomes in elderly patients with or without atrial fibrillation. *Clin Interv Aging.* 2018;13:497–504. <https://doi.org/10.2147/CIA.S147916>
  25. Podolecki T, Lenarczyk R, Kowalczyk J, Marcin S, Andrzej S, Ewa J, et al. Stroke and death prediction with CHA2DS2-vasc score after myocardial infarction in patients without atrial fibrillation. *J Cardiovasc Med (Hagerstown).* 2015;16(7):497–502. <https://doi.org/10.2459/JCM.0000000000000241>
  26. Melgaard L, Gorst-Rasmussen A, Lane DA, Rasmussen LH, Larsen TB, Lip GY. Assessment of the CHA2DS2-VASc Score in Predicting Ischemic Stroke, Thromboembolism, and Death in Patients With Heart Failure With and Without Atrial Fibrillation. *JAMA.* 2015;314(10):1030–1038. <https://doi.org/10.1001/jama.2015.10725>
  27. Engbers MJ, van Hylckama Vlieg A, Rosendaal FR. Venous thrombosis in the elderly: incidence, risk factors and risk groups. *J Thromb Haemost.* 2010;8(10):2105–2112. <https://doi.org/10.1111/j.1538-7836.2010.03986.x>

# PAGET'S DISEASE OF BONE DIAGNOSED ON SPECT/CT: A CASE REPORT

V. Vyazmin<sup>1,2</sup>

<sup>1</sup>Professor V. F. Voino-Yasenetsky Krasnoyarsk State Medical University, Krasnoyarsk, Russian Federation

<sup>2</sup>A.I. Kryzhanovsky Krasnoyarsk Regional Clinical Oncology Center

## Abstract

I reported a case of a seventy-five-year-old woman with a backache and pain in left femur. Magnetic resonance imaging (MRI) of back, pelvis and hips showed bone marrow lesion suggesting bone metastasis. The patient was admitted to nuclear medicine department of Krasnoyarsk Regional Clinical Oncology Center. Single-photon emission computed tomography combined with computed tomography (SPECT/CT) of the skeletal system together with several laboratory tests (alkaline phosphatase, calcium, phosphorus), provided grounds for the diagnosis of Paget's disease. The patient was qualified for treatment to the Rheumatologist.

## Keywords

Paget's disease of bone • bone pain • metabolic bone diseases • SPECT/CT • alkaline phosphatase

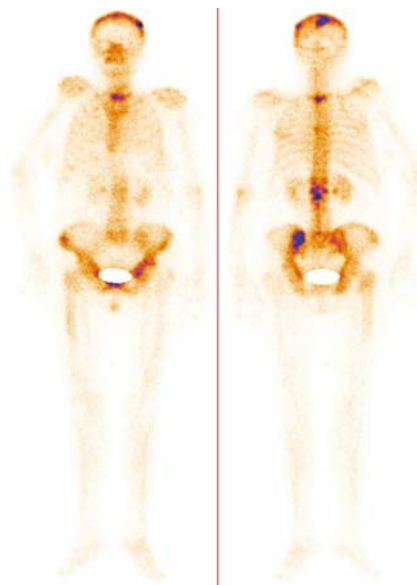
## Introduction

Paget's disease of bone (PDB) is a chronic progressive disease of the bone of uncertain etiology, characterized initially by an increase in bone resorption, followed by a disorganized and excessive formation of bone, leading to pain, fractures, and deformities. PDB is the most common metabolic bone diseases after osteoporosis [1]. The disease predominately affects elderly and male patients [2]. The article describes the utility of single photon emission computed tomography combined with computed tomography (SPECT/CT) to rule out metastatic bone disease in a patient Paget's disease mimicking multiple skeletal metastases.

## Case report

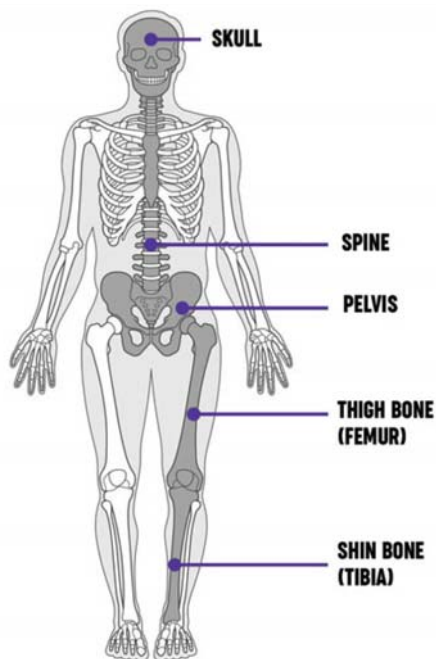
A 75-year-old woman, presented with a history of backache and pain in left femur. She also complained of excessive worries, tension, and having sleep disturbance. There was no past history of diabetes, hypertension, tuberculosis, polyarthritis, or any other significant illness. The family history was not contributory. Magnetic resonance imaging (MRI) of back, pelvis and hips showed bone marrow lesion suggesting skeletal metastases. The patient was admitted to the nuclear medicine department of the Krasnoyarsk Regional Clinical Oncology Center. Whole-body bone scintigraphy was performed two hours after

intravenous administration of technetium-99m methylene diphosphonate (MDP). Images revealed multiple skeletal lesions ("hot spots") involving skull, multiple vertebrae, pelvis on both sides, and upper half of the right femur (Figure 1).



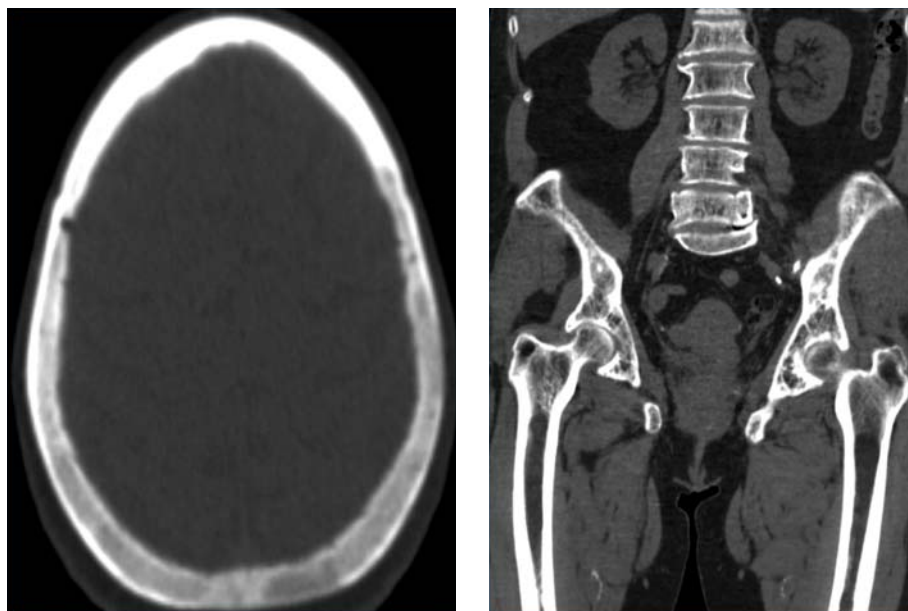
**Figure 1.** Planar bone scintigraphic images showing increased tracer uptake in skull, multiple vertebrae, pelvis on both sides and upper half of the right femur.

The scintigraphic features were suggestive of polyostotic Paget's disease (Figure 2).



**Figure 2.** The bones commonly affected by Paget's disease.

Computed tomography (CT) scan revealed diffuse osteosclerosis with lytic areas involving skull, thoracic and lumbar vertebrae, pelvis on both sides and upper half of the right femur, commensurate with the bone scan findings (Figure 3).



**Figure 3.** CT scan showing structural lesion areas involving skull, lumbar vertebrae, pelvis on both sides and upper half of the right femur, commensurate with the bone scan findings.

Biochemical tests revealed normal serum calcium: 2.3 mmol/L (2.2-2.55 mmol/L) and serum phosphorus: 1.23 mmol/L (0.81-1.45 mmol/L), but markedly raised serum alkaline phosphatase (SAP) – 683 IU/L (35-105 IU/L). Correlating the clinical, radiologic and biochemical findings a final diagnosis of PDB was established. Patient was qualified to the Rheumatologist for treatment.

## Discussion

PDB is a chronic, non-inflammatory, localized bone-remodeling disorder that affects widespread, non-contiguous areas of the skeleton. PDB is the second most common bone disease after osteoporosis [3]. This disease is relatively common in older people, occurs in approximately 3-4% of the population aged over 50 years with a slight male gender predilection. PDB can be monostatic or polyostotic in nature depending on the number of bones involved. Most commonly involved bones are the pelvic girdle, spine, lumbar region, thoracic region as well as and cervical and skull bones. Most cases are asymptomatic in nature but symptomatic cases may lead to various manifestations such as arthritis, bone pain, pathological fractures, bowing of legs and kyphosis [4].

PDB is diagnosed primarily by radiological examinations. Early in the course of the disease, lytic activity predominates, causing focal osteolytic lesions. Subsequently, areas of sclerosis develop, leading to the characteristic appearances of mixed

lytic and sclerotic areas, thickened trabecula, bone expansion, cortical thickening, and deformity. A radioisotope bone scan may be recommended in all patients as part of the initial diagnostic assessment to determine the distribution of the disease [5].

Different biochemical markers of bone remodeling that are increased in PDB play a useful role in the diagnosis of the disease. The markers of bone resorption, which are increased, are: urinary hydroxyproline, serum N-telopeptide of type I collagen, serum C-telopeptide of type I collagen and serum deoxypyridinoline cross-links of type I collagen. Markers of bone formation that are elevated are: SAP, serum bone-specific alkaline phosphatase, osteocalcin, serum N-terminal propeptide of type I collagen [6].

There are several treatment regimens for patients with PDB. Bisphosphonates have been proven as the first-line treatment option, secondary to its influence in bone remodeling. The most commonly used bisphosphonates in the management of Paget's disease are pamidronate, etidronate, zoledronic acid, alendronate and riseridronate [7]. Calcitonin is usually a second-line treatment. This drug is assisted in bone absorption. Supplements such as calcium and vitamin D have been known to provide some symptomatic benefit. Pain management achieved with either nonsteroidal anti-inflammatory drugs (NSAIDs) or acetaminophen [8].

The general outlook for patients with PDB is good, especially if treatment started before major changes have occurred in the bones. There is no cure for PDB, but the disorder can be controlled from progressing. Patients with severe polyostotic Paget disease have a less favorable prognosis than those with monostotic disease [9].

Only one study, however, has specifically addressed mortality associated with PDB. In that study, the British General Practice Research Database identified 2465 patients diagnosed with PDB from 1988 to 1999: retrospective review indicated that 5-year survival was 67% in patients with Paget's disease compared with 72% in control patients [10].

The prognosis is extremely unfavorable if the patient has any type of sarcomatous degeneration, especially if there is multicentricity. The 5-year survival rate of Paget's sarcoma is approximately 10%, much worse than that of conventional osteosarcoma, which has increased to nearly 70% with the improvement of neoadjuvant chemotherapy. Most tumors show a poor response to standard chemotherapy regimens used for conventional osteosarcoma [11, 12].

## Conclusion

This case presented utility of SPECT/CT uniting isotope bone scan and CT-scan in diagnostics of PDB which can be confirmed by elevated alkaline phosphatase levels in serum which was positive in our patient, too.

## Conflict of Interest Statement

Author declares no conflict of interests for this article

## References

- Shankar YU, Misra SR, Vineet DA, Baskaran P. Paget disease of bone: A classic case report. *Contemp Clin Dent*. 2013;4(2):227–30. <https://doi.org/10.4103/0976-237X.114858>
- Kumar AA, Kumar P, Prakash M, Tewari V, Sahni H, Dash A. Paget's disease diagnosed on bone scintigraphy: Case report and literature review. *Indian J Nucl Med*. 2013;28(2):121–3. <https://doi.org/10.4103/0972-3919.118258>
- Roodman GD, Windle JJ. Paget disease of bone. *J Clin Invest*. 2005;115(2):200–8. <https://doi.org/10.1172/JCI24281>
- Rai NP, Anekar J, Mustafa SM, Devang Divakar D. Paget's disease with craniofacial and skeletal bone involvement. *BMJ Case Rep*. 2016;2016:bcr2016216173. <https://doi.org/10.1136/bcr-2016-216173>
- Mustafa S. A 65-Year-Old Female with Paget's Disease of Skull. *Journal of Enam Medical College*. 2016;6(2):106–9. <https://doi.org/10.3329/jemc.v6i2.27767>
- Seibel MJ. Biochemical markers of bone turnover: part I: biochemistry and variability. *Clin Biochem Rev*. 2005;26(4):97–122.
- Wat WZM. Current perspectives on bisphosphonate treatment in Paget's disease of bone. *Ther Clin Risk Manag*. 2014;10:977–83. <https://doi.org/10.2147/TCRM.S58367>
- Muschitz C, Feichtinger X, Haschka J, Kocijan R. Diagnosis and treatment of Paget's disease of bone: A clinical practice guideline. *Wien Med Wochenschr*. 2017;167(1-2):18–24. <https://doi.org/10.1007/s10354-016-0502-x>
- Wermers RA, Tiegs RD, Atkinson EJ, Achenbach SJ, Melton LJ 3rd. Morbidity and mortality associated with Paget's disease of bone: a population-based study. *J Bone Miner Res*. 2008;23(6):819–25. <https://doi.org/10.1359/jbmr.080215>
- van Staa TP, Selby P, Leufkens HG, Lyles K, Sprafka JM, Cooper C. Incidence and natural history of Paget's disease of bone

- in England and Wales. *J Bone Miner Res.* 2002;17(3):465–71. <https://doi.org/10.1359/jbmr.2002.17.3.465>
11. Deyrup AT, Montag AG, Inwards CY, Xu Z, Swee RG, Krishnan Unni K. Sarcomas arising in Paget disease of bone: a clinicopathologic analysis of 70 cases. *Arch Pathol Lab Med.* 2007;131(6):942–46. [https://doi.org/10.1043/1543-2165\(2007\)131\[942:SAIPDO\]2.0.CO;2](https://doi.org/10.1043/1543-2165(2007)131[942:SAIPDO]2.0.CO;2)
12. Mankin HJ, Hornicek FJ. Paget's sarcoma: a historical and outcome review. *Clin Orthop Relat Res.* 2005;438:97–102. <https://doi.org/10.1097/01.blo.0000180053.99840.27>

# PRACTICE, PERCEPTION, AND ASSOCIATIONS OF PEER LEARNING AMONG RESIDENT DOCTORS IN NIGERIA: CHARTING STUDY

Oladimeji Adebayo<sup>1</sup>, Martin Igbokwe<sup>2</sup>, Kehinde Kanmodi<sup>3</sup>, Abimbola Amoo<sup>1</sup>, Olusegun Olaopa<sup>1</sup>, Sebastine Oiwoh<sup>4</sup>, Selekewei Peter Kespi Kpuduwei<sup>5</sup>, Elizabeth Grillo<sup>6</sup>, Rereloluwa Babalola<sup>2</sup>, Gbenga Popoola<sup>7</sup>, Florence Anne Oladimeji<sup>2</sup>, Ayanfe Omololu<sup>7</sup>, Oluwaseyi Ogunsuji<sup>1</sup>, Francis Fagbule<sup>1</sup>, Babalola Adeniyi Ibisola<sup>1</sup>, Oluwafemi Efuntoye<sup>1</sup>, Makinde Adeniyi Adebayo<sup>7</sup>, Dabota Yvonne Buowari<sup>8</sup>, Aliyu Sokomba<sup>9</sup>

<sup>1</sup>University College Hospital, Ibadan, Nigeria

<sup>2</sup>Obafemi Awolowo Teaching Hospital Complex, Ile-Ife, Nigeria

<sup>3</sup>Kebbi Medical Centre, Kebbi, Nigeria

<sup>4</sup>LAUTECH Teaching Hospital, Ogbomosho, Nigeria

<sup>5</sup>Federal Medical Centre, Yenagoa, Nigeria

<sup>6</sup>Federal Medical Centre, Abeokuta, Nigeria

<sup>7</sup>Federal Teaching Hospital, Ido Ekiti, Nigeria

<sup>8</sup>University of Port Harcourt Teaching Hospital, Port Harcourt, Nigeria

<sup>9</sup>Ahmadu Bello University Teaching Hospital, Zaria, Nigeria

## Abstract

**Introduction:** Peer learning is an important component of the postgraduate medical curriculum, and it is considered as an integral part of learning in some countries. The practice of peer learning among postgraduate trainees, especially the resident doctors, is an area that has not been explored in Nigeria and other third world countries. This study aims to examine the practice, perception, and drivers of peer-to-peer training in Nigeria.

**Methodology:** This study was a national multi-centre and multi-disciplinary cross-sectional survey, conducted among resident doctors in Nigeria. Semi-structured questionnaires were used to obtain respondents' biodata, perception and practice on peer learning. Data were analysed using SPSS version 23 software. Results were presented as frequency table and proportion, means, and standard deviation. Inferential statistics such as bivariate analysis was performed.

**Results:** Majority, 287 (73.2%), considered the peer education programme as an appropriate learning practice, 173 (45.9%) considered peer education programme integrated part of the training, while 350/383 (88.2%) engaged in a peer education programme. Statistically, a significant association was found between those who considered peer training as appropriate ( $p = 0.038$ ) and those who considered peer education as an integral part of postgraduate medical training curriculum ( $p = 0.009$ ).

**Conclusion:** Peer learning is popular among resident doctors in Nigeria. Concerted efforts are needed to re-structure the residency training curriculum in order to maximize the benefits of this learning approach for an effective training programme.

## Keywords

Nigeria • medical • residents • doctors • peer • education • learning • medical • residents-as-teachers

## Introduction

Peer learning, near-peer learning or peer-to-peer learning can be defined as an educational concept in which one trainee provides learning support to another trainee or a group of fellow trainees [1-3]. A similar term is peer-assisted learning [1]. This approach to learning is a real opportunity for trainees considering the dearth of didactic lectures in most residency training programmes. Although the residency training programme is a structured one, it essentially involves

a great deal of self-driven learning and improvement. Furthermore, given the contemporary explosion of medical knowledge and skill required for specialist medical practice, resident doctors and interns have an enormous volume of information and competencies to acquire within a fixed training period. However, there is poor insight into how this feat is achieved. Peer learning may thus play some role in this regard [4].



Peer Learning is in fact considered to be an “under-recognised source of education in the medical education continuum” [5]. Besides, it is considered to be an innovative way to disseminate information rapidly, and an excellent way to entrench interprofessional collaboration. The latter may be necessary for the medical and dental practice, where team spirit is a necessary soft skill [6]. It may be an excellent way to inculcate teaching skills into resident doctors who are future faculties [5, 6]. Finally, there is evidence, albeit little, on its benefit in sharing theoretical and practical medical skills [7, 8]. A unique characteristic of the peer teachers or tutors is that it mostly takes place in semi-formal, non-classroom settings or arrangements.

Academic exchange between early career Doctors who are mainly residents doctors is poorly explored, especially in Nigeria [9, 10]. Furthermore, peer learning/teaching is a poorly explored part of the postgraduate medical curriculum; it is, therefore, imperative to characterise such and assess the perception of the participants themselves.

This study examined the practice and perception of resident doctors to peer-peer training experience in Nigeria.

## Methods

### **Study design**

This study was a national multi-centre, multi-disciplinary cross-sectional survey of resident doctors, who are early career doctors in Nigeria [11-13]. This study also forms a part of the CHARTING study; also, the study protocol had been published elsewhere, and preliminary data was also presented as a poster [12, 14].

### **Study tool**

The study tool was an anonymous pre-tested, semi-structured paper questionnaire which obtained information about the basic demographics, practice, and perception of the study participants towards peer learning [12]. The basic characteristics of participants were extracted with 17 variables while those variable relevant to peer learning where gotten via seven stem questions.

### **Selection criteria**

Only those doctors who were identified as resident doctors (i.e. a registrar/senior registrar) [9, 11] and who also gave verbal informed consent were included in this study.

### **Data collection and analysis**

The survey was institution-based. Collected data was cleaned, coded, and computed into the IBM SPSS version 23 Software for analysis. Frequency distributions of all variables

were determined. Continuous variables were summarised as mean and standard deviation, while the categorical variables were summarised as proportions and frequencies. Also, bivariate (Chi-square tests) analyses were done among the relevant variables. Results were presented using sentences and tables.

### **Definition of terms**

1. Peer: a trainee who is the same level/cadre with another trainee, e.g. a house officer and another house officer or a senior registrar and another senior registrar.
2. Peer learning: Peer learning or near-peer learning are organised educational activities in which one trainee provide learning support to other trainees (resident doctors) or a group of fellow trainees (resident doctors)
3. Early career doctor: a medical or dental practitioner who has finished first-degree training and at least has a certification to practice clinically. Those in this category include interns, medical/dental officers below the rank of a principal medical/dental officer (PMO/PDO) and resident doctors [10, 12].
4. Registrar: A doctor in postgraduate medical training having passed the Primary exams of either or both of the National Post-graduate Medical College or the West African College following completion of internship and the mandatory one-year National Youth Service Corps [15, 16]. This usually takes between 2-3 years during which he/she learns from the Senior registrar and Consultant.
5. Senior Registrar: A doctor in residency training following success at the Part I exams of the College/s who directly supervises the registrar and interns under the overall guidance and tutelage of the Consultant [15, 16]. This programme usually lasts between 2-4 years depending on the specialty and culminates in success at the Part II examinations after which he/she is awarded a Fellowship and is appointable as a Consultant in a relevant health institution.
6. Specialty was considered as the department/field the trainee is currently under, while the grouping into surgical-related and non-surgical related was based on the Nigerian/West African Postgraduate Medical Colleges' classifications.

### **Ethical Considerations**

Ethical approval was obtained from the National Ethics Review Committee, Federal Ministry of Health, Nigeria, before data collection (Reference number: NHREC/01/01/2007-26/06/2019). Written and verbal consent were obtained from each participant before their participation. Also, the identity of each participant was treated with utmost confidentiality.

## Results

A total of 411 participants were included in this report. The mean ( $\pm$ SD) age of the respondents was 35.3 ( $\pm$ 4.5) years. The majority (72.0%) were males, 77.8% were married, 53.3% were registrars, 55.7% were in non-surgical specialities, 58.4% graduated from medical school more than seven years previously, and only 79 (19.3%) had acquired additional educational qualifications (like Masters or PhD)(Table 1).

The respondents spent averagely 69.36( $\pm$ 34.71) hours-per-week, 9.75 ( $\pm$ 8.96) hours-per-week, and 3.98 ( $\pm$ 5.79) hours-per-week on hospital works, private study, and research activities, respectively (Table 2). More than 90% spent over 40 hours per week at work, 61% being on-call duty for more than seven days in a month, and the majority having no free time after call duties.

The majority (73.2%) of the respondents considered peer education programmes/sessions as an appropriate educational practice; however, only 45.9% indicated that peer education programme was an integrated part of their training requirement. Among them, only 88.2% (350/383) engaged themselves in peer education programme(s) including social media discussion programmes (243/365, 66.6%), discussion group activities (327/365, 89.6%), and others (e.g. bedside teaching, among others) (13/365, 3.6%) (Table 3).

As shown in Table 4, a statistically significant association was found between participation in peer learning activities and consideration of peer education as an integral part of the curriculum as well as with consideration of peer training as appropriate. About nine out of every ten (91.6%) of those who considered peer education as an integral part of the curriculum participated in peer-education, as compared to only 84.9% of those who did not consider it as an integral part of the curriculum. Furthermore, 91.6% of those who considered peer training appropriate participation in peer education as compared to 84.2% of those who did not consider it appropriate. There was no significant association between age, gender, cadre and duration of practice of resident doctors and participation in peer education programmes.

## Discussion

Worldwide, the theme of peer-to-peer education is an understudied subject and one with an enormous potential to improve knowledge dissemination and skill acquisition, especially among resident doctors. Peer-assisted learning has commonly been known to be implemented in medical education via programmes like ward-rounds, bedside

teaching and other interactive sessions. However, it has more commonly been studied among medical students than doctors in postgraduate training [17-19]. Our study demonstrated that a high proportion of the respondents (88.2%) engage in peer learning activities. Among Nigerian resident doctors, discussion groups, social media interactions and bedside discussions were the most common modalities of peer education.

There are many apparent advantages of peer education. According to Burgess et al., the peer teachers do not only develop teaching skills which are vital for all doctors but also improve their clinical knowledge and acumen [20]. Considering that this form of interaction occurs amongst resident doctors of similar cadre, there is a more relaxed and friendly atmosphere which allows for an adequate learning experience. Some researchers have demonstrated that more senior resident doctors in postgraduate training were able to impart knowledge on their junior colleagues by teaching during ward rounds and other clinical settings [21]. It was also found that there is no significant difference in the degree of knowledge impartation to residents between peer-led and faculty-led teachers [17]. Interestingly, in imparting certain skill sets there is evidence that peer learning may be better, possibly due to participants being of similar age brackets thereby enhancing those particular skill transfer [2]. These residents learn much more and prepare for the seminars and discussions much more intensively thus being beneficial to the peer trainers themselves. However, we did not test this in our study.

From this study, approximately 70% of respondents considered peer education appropriate for their learning and development. However, less than half agreed that peer education was integrated into the residency training programmes in their various institutions. This suggests that there is a need for increased integration of peer-to-peer education within the curriculum of the residency training programme in Nigeria.

This study highlighted the increased workload among the participants - 91% of the participants worked more than 40 hours per week, and at least 60% of participants were on call for more than 7 days in a month. It can thus be extrapolated that, given the fact that residents who take regular calls have increased need for rest and recovery, there may be little, or no time left for peer education. Furthermore, above 60% of residents in this study had less than 7 hours of structured training by their trainers in a week, with less than 10 hours of private time for studies. This inadequate time for personal study/training by the resident might further make peer learning more challenging. On the flip side, the same dearth of time for other methods of learning and the compelling need for learning to succeed in the training may have served a strong driver of the practice of peer learning. Also interesting is the fact that those who engage in peer learning

self-reported similar structured hours learning from trainers and self-reported hours of private study per week. It would be interesting to further explore how residents overcome the increase workload and thrive in peer learning practice.

Of the 85% who engaged in peer-to-peer education, a vast majority (9 out of 10) participated in group discussions while a significant population engaged in social media interactive groups.

Habboush et al. identified four main themes which are essential in developing the teaching skills of residents, namely communication, professional engagement, practice-based learning, and systems-based learning [22]. They revealed a remarkably positive difference in the ability of the resident doctors he studied, to teach their peers and medical students following a structured-training [22]. To this effect, there may be a need for proper training on these methods to enhance better outcomes.

Walker and her associates reported the use of the jigsaw technique in peer teaching and learning among American paediatric resident doctors, with the remarkable results of satisfactory knowledge transfer from resident to resident [23].

The jigsaw technique, among other techniques of peer-to-peer education, encourages a resident doctor to study and become an expert in a particular aspect of a topic, and then teach colleagues during group discussions while learning about other aspects from them. In other words, this approach allows much ground to be covered over a short period [24]. There are many more techniques that have been practised by Nigerian resident doctors but have not been documented due to inadequate knowledge of the theme of peer-to-peer education.

This index study showed no obvious statistically significant difference in the perception, integration and engagement in peer education based on gender, age groups, marital status and type of specialty (surgical versus non-surgical). It thus suggests that it is useful across board, and should thus be further studied and understood in order to maximise its usefulness [25].

We did not explore how these activities affect skilled transfer, and capacity enhancement. This is a potential gap that further research would be needed to provide insight.

## Conclusion

Peer learning/education is popular among Nigerian resident doctors. The residents who recognised peer learning as appropriate were more likely to participate further in peer training. It is therefore imperative for the stakeholders in the Nigerian Postgraduate Training Programme to encourage the integration of well-structured peer education into the residency training programme with the goal of making training/learning more efficient.

## Acknowledgements

The National Executive Council of NARD, Research Collaborator Network advisors and the CHARTING study Research Assistants (Tobi Akande, IyanuAdufe and Bunmi).

**Funding body:** Nigerian Association of Resident Doctors (NARD).

## Conflict of Interest Statement

All authors are members of NARD except KK, IA while OO, SO, SO and AS are officials of NARD; however, the study was independently conducted and reported. NARD played only a funder's role.

## References

1. Topping KJ. Trends in Peer Learning. *Educational Psychology*. 2005;25(6):631–45. <https://doi.org/10.1080/01443410500345172>
2. Knobe M, Munker R, Sellei RM, Holschen M, Mooij SC, Schmidt-Rohlfing B, et al. Peer teaching: a randomised controlled trial using student-teachers to teach musculoskeletal ultrasound. *Med Educ*. 2010;44(2):148–55. <https://doi.org/10.1111/j.1365-2923.2009.03557.x>
3. Bulte C, Betts A, Garner K, Durning S. Student teaching: views of student near-peer teachers and learners. *Med Teach*. 2007;29(6):583–90. <https://doi.org/10.1080/01421590701583824>
4. Thomas PA, Gebo KA, Hellmann DB. A pilot study of peer review in residency training. *J Gen Intern Med*. 1999;14(9):551–4. <https://doi.org/10.1046/j.1525-1497.1999.10148.x>
5. Ten Cate O, Durning S. Peer teaching in medical education: twelve reasons to move from theory to practice. *Med Teach*. 2007;29(6):591–9. <https://doi.org/10.1080/01421590701606799>
6. Lipton HL, Lai CJ, Cutler TW, Smith AR, Stebbins MR. Peer-to-peer interprofessional health policy education for Medicare part D. *Am J Pharm Educ*. 2010;74(6):102. <https://doi.org/10.5688/aj7406102>

7. Duran-Nelson A, Baum KD, Weber-Main AM, Menk J. Efficacy of peer-assisted learning across residencies for procedural training in dermatology. *J Grad Med Educ.* 2011;3(3):391–4. <https://doi.org/10.4300/JGME-D-10-00218.1>
8. Naeger DM, Conrad M, Nguyen J, Kohi MP, Webb EM. Students teaching students: evaluation of a “near-peer” teaching experience. *Acad Radiol.* 2013;20(9):1177–82. <https://doi.org/10.1016/j.acra.2013.04.004>
9. Adebayo O, Fagbule OF, Omololu A, Ibrahim YA, Isibor E, Olaopa O, et al. We are NARD We are Early Career Doctors. Abuja: National Association of Resident Doctors of Nigeria; 2019.
10. NARD. Initiating Trainee Research Collaboration Network: A NARD Initiative in Nigeria. Abuja: National Association of Resident Doctors of Nigeria (NARD); 2019. 12 p.
11. Adebayo O, Oluwaseyi O, Olaopa O, Kpuduwei S, Oluwafemi E, Omotayo FF, et al. Trainees collaboratively investigating early career doctors’ themes: a NARD initiative in Nigeria. *Niger J Med.* 2019;28(1):93–7.
12. Kanmodi K, Ekundayo O, Adebayo O, Efuntoye O, Ogunsuji O, Ibiyo M, et al. Challenges of residency training and early career doctors in Nigeria study (CHARTING STUDY): a protocol paper. *Niger J Med.* 2019;28(2):198–205.
13. Igbokwe M, Babalola I, Adebayo O. CHARTING Study: A Trainee Collaborative Research Study. *Junior Doctors Network Newsletter.* 2019;16:23–4.
14. Adebayo O, Olaopa O, Ogunsuji O, Efuntoye O, Sebastine O, Fagbule OF, et al. N005A Practice and perception of early career doctors (ECDs) to peer education/learning experience from Nigeria: preliminary report from charting study. 39th Annual General Meeting of National Association of Resident Doctors of Nigeria; 2019.
15. Nwachukwu AC. The State Of Residency Training In Nigeria – Resident Doctors’ Perspective. *World Journal of Innovative Research.* 2019;6(4):109–12.
16. Okonofua FE. Postgraduate medical education in Nigeria: Past, present, and future. *Trop J Obstet Gynaecol.* 2018;35(1):1–13. [https://doi.org/10.4103/tjog.tjog\\_54\\_16](https://doi.org/10.4103/tjog.tjog_54_16)
17. Engels D, Kraus E, Obirei B, Dethleffsen K. Peer teaching beyond the formal medical curriculum. *Adv Physiol Educ.* 2018;42(3):439–48. <https://doi.org/10.1152/advan.00188.2017>
18. Lockspeiser TM, O’Sullivan P, Teherani A, Muller J. Understanding the experience of being taught by peers: the value of social and cognitive congruence. *Adv Health Sci Educ Theory Pract.* 2008;13(3):361–72. <https://doi.org/10.1007/s10459-006-9049-8>
19. Iwata K, Furmedge DS, Sturrock A, Gill D. Do peer-tutors perform better in examinations? An analysis of medical school final examination results. *Med Educ.* 2014;48(7):698–704. <https://doi.org/10.1111/medu.12475>
20. Burgess A, McGregor D, Mellis C. Medical students as peer tutors: a systematic review. *BMC Med Educ.* 2014;14:115. <https://doi.org/10.1186/1472-6920-14-115>
21. Kulkarni VT, Salgado SM, Pelletier SR, Shields HM. Teaching methods used by internal medicine residents on rounds: what works? *Adv Med Educ Pract.* 2019;10:15–21. <https://doi.org/10.2147/AMEP.S181153>
22. Habboush Y, Stoner A, Torres C, Beidas S. Implementing a clinical-educator curriculum to enrich internal medicine residents’ teaching capacity. *BMC Med Educ.* 2019;19(1):459. <https://doi.org/10.1186/s12909-019-1888-0>
23. Walker S, Olvet DM, Chandran L. The jigsaw technique of peer teaching and learning: An efficient and enjoyable teaching strategy in medicine. *MedEdPublish.* 2015;6:14. <http://dx.doi.org/10.15694/mep.2015.006.0014>
24. Aronson E, Stephan C, Sikes J, Blaney N, Snapp M. *The Jigsaw Classroom.* Beverly Hills, California: Sage Publications; 1978.
25. Fakhouri Filho SA, Feijó LP, Augusto KL, Nunes MDPT. Teaching skills for medical residents: are these important? A narrative review of the literature. *Sao Paulo Med J.* 2018;136(6):571–8. <https://doi.org/10.1590/1516-3180.2018.0147060818>

## Tables

**Table 1.** Basic Profile of Participants

Variables (n)		
Age (368)	(mean SD) years	35.3± 4.5
	<40years n (%)	307(83.4)
	more than or equal to 40years	61(16.6)
Gender (411)	Male n (%)	296(72.0)
	Female n (%)	115(28.0)
Cadres (411)	Registrar n (%)	219(53.3)
	Senior Registrar n (%)	192(46.7)
Married status (409)	Yes	318(77.8)
	No	91(22.2)
Categories of specialty (402)	Surgical related n (%)	178(44.3)
	Non-surgical related n (%)	224(55.7)
Undergraduate training (397)	Foreign n (%)	5(1.3)
	Foreign-trained n (%)	392(98.7)
Years of graduation from medical school (397)	less or equal to 7years n (%)	157(38.2)
	more than 7years n (%)	240(58.4)
Additional qualification (Master, PhD, PGD)(410)	Yes n (%)	79(19.3)
	No n (%)	331(80.7)
Number of children	less than or equal to 2 children	224(78.3)
	more than 2 children	62(21.7)
Average hour of sleeps per day (396)	less or equal to 7 hours	374(92.8)
	more than 7	29(7.2)

**Table 2.** Work-related Characteristics of participants

Variables (n)		
Years of practice (396)		
	less or equal to 7years	202(51.0)
	more than 7years	194(49.0)
Years on current job(396)		
	less or equal to 5 years	271(70.6)
	more than 5 years	113(27.5)
Average work hours per week (391)		
	less than 40 hours	34(8.7)
	more or equal to 40 hours	357(91.3)
Number of call days in a month (393)		
	less or equal to 7	157(39.9)
	greater than 7 days	236(60.1)
Mode of calls duty (401)		
	Staggered	339(84.5)
	Not staggered	62(15.5)
Usual Free hours after each call(376)		
	equal or less than 7 hours	150(87.2)
	more than 7 hours	22(12.8)
Hours of formal educational activities in a week(376)		
	less or equal to 5 hours	173(46.0)
	more 5 hours	203(54.0)
Dedicated Private or research hours per week (339)		
	less or equal to 5 hours	123(36.4)
	more 5 hours	215(63.6)



**Table 3.** Peer Learning Activities and Residency Related Attributes

Variables (n)		
Do you consider peer educational program/sessions such as discussion group appropriate (397)	Yes	287(73.2)
	No	95(24.2)
	Undecided	10(2.6)
Do you engage in peer educational program such as discussion group seminars (383)	Yes	350(88.2)
	No	47(11.8)
Peer education engage in Discussion group (383)	Yes	332(86.7)
	No	51(13.3)
Peer education engage in Others (240)	Yes	14(5.8)
	No	226(94.2)
Is the peer education programme integrated as part of your training requirement (377)	Yes	173(45.9)
	No	172(45.6)
	Undecided	32(8.5)
Reported structured hour of training in residency by trainers (269)	0-7 hours	179(66.5)
	8 hours or more	90(33.5)
Reported hours of private study per week (338)	10 hours equal or less	237(70.1)
	More than 10 hours	101(29.9)

**Table 4.** Factors associated with participation in peer learning activities

	Yes	No	X <sup>2</sup>	p-value
Age			0.41	0.518
less than 40 years	266(88.1)	36(11.9)		
more than or equal to 40 years	317(88.5)	41(11.5)		
Gender(397)			3.04	0.081
Male	248(86.4)	39(13.6)		
Female	102(92.7)	8(7.3%)		
Marital Status(395)			2.61	0.101
Married	274(89.5)	32(10.5)		
Not married	74(83.1)	15(16.9)		
Cadre (397)			0.43	0.513
Registrar	189(89.2)	23(10.8)		
Senior Registrar	161(87.0)	24(13.0)		
Type of specialty (390)				
Surgical related	151(88.8)	19(11.2)	0.22	0.641
non-surgical related	192(87.3)	28(12.7)		
Location of undergraduate medical training (384)				
Foreign	4(100.0)	0		
not foreign-trained	333(87.6)	47(12.4)		
Years of graduation from medical school (383)			0.08	0.781
less or equal to 7years	132(87.4)	19(12.6)		
more than 7years	205(88.4)	27(11.6)		
Years of practice (383)			0.00	0.955
less or equal to 7years	170(88.1)	23(11.9)		
more than 7 years	167(87.9)	23(12.1)		
Years on current job (371)			3.65	0.056
less or equal to 7 years	237(90.5)	25(9.5)		
more than 7 years	91(83.5)	18(16.5)		

---

Average work hours per week) (378)			0.02	0.778
less than 40	26(86.7)	4(13.3)		
more or equal to 40	305(87.6)	43(12.4)		
Number of days on-call duty in a month (380)			0.00	0.959
less or equal to 7 days	132(88.0)	18(12.0)		
Greater than 7 days	202(87.8)	28(12.2)		
Usual Mode of call duty (388)			0.1	0.753
Staggered	289(88.1)	39(11.9)		
Not staggered	52(86.7)	8(13.3)		
Free hours after each call (164)			0.27	0.706
equal to or less than 7	128(89.5)	15(10.5)		
more than 7 years	18(85.7)	3(14.3)		
Considered peer education as an integral part of the curriculum (345)			6.91	0.009**
Yes	162(93.6)	11(6.4)		
No	146(84.9)	26(15.1)		
Consider peer training appropriate (382)			4.30	0.038**
Yes	263(91.6)	24(8.4)		
No	80(84.2)	15(15.8)		
Reported structured hours learning from trainers			0.02	0.224
Less or equal to 10 hours	216(91.1)	21(8.9)		
More than 10 hours	27(84.4)	5(15.6)		
Reported hours of private study per week			0.32	0.574
10 hours equal or less	129(89.0)	16(11.0)		
More than 10hours	163(90.1)	18(9.9)		

---

# POISONING-INDUCED NON-CARDIOGENIC PULMONARY EDEMA: MECHANISM AND OUTCOME

Chih-Chun Hsu<sup>1</sup>, Nai-Hui Lin<sup>1</sup>, Hsiu-Wu Yang<sup>1</sup>, Yu-Jang Su<sup>1,2,3</sup><sup>1</sup>Emergency Department, Mackay Memorial Hospital, Taipei City 10449, Taiwan.<sup>2</sup>Poison Center, Emergency Department, Mackay Memorial Hospital, Taipei City 10449, Taiwan.<sup>3</sup>Department of Medicine, Mackay Medical College, New Taipei City, Taiwan.

## Abstract

**Background:** pulmonary edema results from the shift of excessive fluid into the alveoli space and can be clinically classified into cardiogenic or non-cardiogenic by pathophysiology. This study aimed to elucidate the mechanism, outcomes, and prevention of poisoning induced non-cardiogenic pulmonary edema (PINCPE).

**Materials and methods:** we conducted a study on etiology, epidemiology, mechanism, risk, and length of hospital stay in PINCPE. A PubMed search using terms: poisoning and non-cardiogenic pulmonary edema. From 1986 to 2017, a total of 15 articles with 16 cases (2 cases in one article) were included. Cut-off value of mean age was used for classification of subjects into younger group and older group, and length of stay (LOS) was compared between the two groups.

**Results:** the age range of the patients was 7 to 72 years, and the average age (mean±SD [standard deviation]) was 35.7±19.5 years. Among the reported substances in PINCPE, calcium channel blockers (CCBs) were most frequently used (n=8; 50%). In electrocardiogram (ECG), sinus tachycardia (n=8; 50%) was the most common finding. The overall rate of intubation with mechanical ventilator support was 81.3%. The mortality rate was 12.5%. Among patients with PINCPE, LOS was significantly shorter in the younger group aged <35.7 years than in the older group (5.7 vs. 8.9; p=.022).

**Conclusion:** CCB was the most common etiologic agent in PINCPE. Up to 81.3% of PINCPE cases required intubation with ventilator support due to respiratory failure. LOS may increase 3.2 days if the case is complicated with extra-pulmonary organ failure.

## Keywords

poisoning • non-cardiogenic lung edema • prevention

## Abbreviations

ABG .....	Arterial blood gas	NT-proBNP .....	N-terminal proBNP
ADHF .....	Acute decompensated heart failure	PEEP .....	Positive end expiratory pressure
AMS .....	Altered mental status	PINCPE .....	Poisoning induced non-cardiogenic pulmonary edema
BNP .....	B-type natriuretic peptide	RR .....	Respiratory rate
CCB .....	Calcium channel blocker	SBP .....	Systolic blood pressure
CI .....	Confidence interval		
CNS .....	Central nerve system		
DBP .....	Diastolic blood pressure		
ECG .....	Electrocardiogram		
HR .....	Heart rate		
ICU .....	intensive care unit		
LOS .....	Length of stay		
MAP .....	Mean arterial pressure		
MD .....	Mean difference		
MDMA .....	3,4-methylenedioxy-methamphetamine		
MOF .....	Multiorgan failure		

## Introduction

Pulmonary edema results from a shift of excessive fluid into the alveoli space due to alteration in the balance between various Starling's forces, and is clinically classified into cardiogenic or non-cardiogenic based on pathophysiology. In non-cardiogenic pulmonary edema, medications or

illicit drugs are the common etiological agents [1]. A study enrolling 241 patients with pulmonary complications after heroin use reported that pulmonary edema is one of the major complications in 24 patients (10%) [2]. Another retrospective study enrolling 149 patients with AMS with depressed respiratory status after heroin use reported that pulmonary edema was confirmed in 71 patients (48%) [3]. Multiple mechanisms implicated in drug-induced pulmonary edema include inhibition of prostacyclin synthesis by aspirin, and opiate-related mast cell degranulation [4]. Calcium entry blockers can cause selective systemic precapillary vasodilation with associated peripheral edema, and the lung edema may contribute to precapillary vasodilatation resulting in excess pulmonary capillary transudate [5, 6]. Pulmonary edema is a true medical emergency, and treatment varies according to the underlying pathophysiologic mechanisms. This study aimed to clarify the mechanism, outcome, and prevention in PINCPE through PubMed search of previous published cases reports.

## Materials and Methods

### Database search

This article was designed as a systematic review on etiology, epidemiology, mechanism, risk, and LOS in PINCPE. Since no human or animal subjects were involved in the study, ethics approval was not required. Electronic search was performed in PubMed from January, 1991 to December, 2018. To maximize sensitivity of the search strategy and identify all studies, a combination of terms was used as follows: poisoning and non-cardiogenic pulmonary edema. From 1986 to 2017, total 36 case reports were retrieved, and those were reviewed for further identification of potentially relevant studies. All identified articles were systematically assessed using inclusion and exclusion criteria as follows.

### Selection criteria

In this systematic review, inclusion criteria were as follows: toxic substances, patient's sex, age (years), comorbidity, toxidrome, blood pressure (mmHg) at the time of PINCPE, pulmonary capillary wedge pressure (mmHg), heart rate (beats per minute), electrocardiogram, echocardiogram results, with or without intubation, and length of hospital stay. All data were extracted from the text, tables, and figures of each article. Reviews and articles without detailed case report, and laboratory data were excluded. The flow diagram of the article screening process is shown in Figure 1. In the initial literature search of PubMed, 36 articles were identified, and of those, 21 articles were excluded based on the selection criteria. Finally, a total of 15 articles with 16 cases (2 cases in one article) were included.

### Statistical analysis

The subjects were classified into younger group and older group using the cut-off value of mean age, and LOS was compared between the two age groups.

Statistical analyses were conducted using IBM Statistical Package for the Social Sciences (SPSS) software (version 25 (International Business Machines Corp., New York, USA). Independent sample t-test was used for comparisons between the two groups. The number of patients, means, and standard deviations were pooled to calculate the effect size, MD, and 95% CI. Statistical significance was set at p-value <0.05.

## Results

General data of 16 PINCPE cases enrolled are shown in Table 1. Cases in the US (25%), Turkey (18.75%), UK (12.5%), India (12.5%), Greece (12.5%), France (6.25%), Germany (6.25%), and Denmark (6.25%) were noted. The age range was from 7 to 72 years with mean±SD (standard deviation) of 35.7±19.5 years. Male sex was predominant (n=10). Among the reported substances in PINCPE, CCBs were most common (n=8, 50%), followed in decreasing order by MDMA (n=1; 6.25%), methadone (n=1; 6.25%), methaqualone (n=1; 6.25%), organophosphate (n=1; 6.25%), sodium azide (n=1; 6.25%), salicylate acid (n=1; 6.25%), anti-snake venom serum (n=1; 6.25%), and ethylene glycol (n=1; 6.25%). The range of SBP was from 58 to 179 mmHg, with mean±SD of 99.4±44.4 mmHg. The range of DBP was from 30 to 100 mmHg, with mean±SD of 56.7±23.7 mmHg. In electrocardiogram (ECG), sinus tachycardia (n=8; 50%) was the most common finding, followed by sinus bradycardia and normal sinus rhythm (n=2; 12.5%). The overall rate of intubation with mechanical ventilator support was 81.3% (n=13), and the mortality rate was 12.5%. Among all cases of PINCPE, the average LOS was 7.1±3.6 days. All PINCPE cases were classified according to mean age of > or <35.7 years. Relative shorter LOS was observed in the younger group (age <35.7 years), with significance (5.7 vs. 8.9; p=.022). The heart rate in male patients of poisoning induced non-cardiogenic pulmonary edema is significantly fast than female patients (Figure 2 and Table 2). No statistical difference in terms of SBP, DBP, HR and MAP was observed. The relationship between blood pressures and age is showed in Figure 3.

## Discussion

Pulmonary edema is characterized by excessive accumulation of fluid in the extravascular compartments

of the lungs due to pathophysiologies including increased hydrostatic pressure gradient across the capillary wall, diminished osmotic pressure gradient, and increased capillary permeability. In cardiogenic pulmonary edema, high pulmonary capillary pressure affects the flow of fluid; whereas, in non-cardiogenic pulmonary edema, damage and leakage of the alveolar-capillary membrane allows increased movement of water and proteins from the intravascular space to the interstitial space. The difference of mechanisms contribute to the result of interstitial protein concentration <45 % compared to the plasma value, and >60% in cases of non-cardiogenic pulmonary edema [7].

Many clinicians distinguish PINCPE from cardiogenic pulmonary edema based on clinical evaluation, plasma BNP or NT-proBNP, with or without trans-thoracic echocardiography to confirm or exclude pulmonary edema. The response to diuresis can confirm the diagnosis of cardiogenic lung edema retrospectively. In addition, the findings of a third heart sound or murmurs of valvular regurgitation, or aortic stenosis suggest suspicious cardiogenic pulmonary edema. One observational study reported that plasma BNP level <100 pg/mL was an effective diagnostic tool in ARDS with a sensitivity and specificity of 27 and 95%, respectively [8]. However, those studies have a disadvantage of non-specific findings. For example, acute heart failure could also be caused by ARDS in case of septic shock, and conversely, volume overloading without cardiogenic factors could lead to pulmonary edema. Patients with non-cardiogenic pulmonary edema require long-term ventilator support with higher fraction of inspiration oxygen by combined PEEP support, as compared to those with cardiogenic type [9]. In our study, up to 81.3% of PINCPE cases required intubation with mechanical ventilator support due to respiratory failure.

In the comparison of images, chest radiograph in case of cardiogenic pulmonary edema revealed cardiomegaly with fluffy air-space opacities in both the central and peripheral lungs, patchy distribution of edema while that in non-cardiogenic pulmonary edema revealed peripheral distribution of edema and absence of cardiomegaly [10, 11]. The major causes of non-cardiogenic pulmonary edema include ARDS, high altitude, and neurogenic pulmonary edema; whereas, opioid overdose, pulmonary embolism, eclampsia, and transfusion-related acute lung injury are considered as less common causes of pulmonary edema [12]. PINCPE is a relatively rare form of ARDS; nevertheless, more than 350 drugs have capability to damage the lung parenchyma, airways, pulmonary circulation, pleura, mediastinum, lymph nodes, and neuromuscular system [13]. Hypertension is a common condition in cardiogenic and non-cardiogenic pulmonary edema and develops through various mechanistic pathways: chronic dysregulation of the autonomic nervous system in cardiogenic pulmonary edema,

and massive adrenergic discharge due to direct stimulation of the central nervous system centers in PINCPE. During massive surges in the catecholamine level, the blood volume is shifted from the systemic to pulmonary circulation which causes secondary elevation of the left atrial and pulmonary capillary pressures, and consequently, systemic hypertension and pulmonary edema. Norepinephrine and epinephrine are contributing factors for release of secondary mediators (endorphins, histamine, bradykinin) that can cause brain injury and autonomic dysfunction [14].

The mechanism of PINCPE remains unclear. Thompson et al. proposed that drug overdose is a potential risk factor for PINCPE, such as opioid overdose, salicylate, and calcium channel blocker toxicity [15-19]. Moreover, the mechanism may involve interruption in the balance of prostacyclin synthesis and the cell membrane of the mast cells [4]. The change of hydrostatic forces disrupts the vascular osmotic and oncotic pressure, and compromises the epithelial integrity of the lung alveoli, which increases the interstitial flow of the lymphatic system, and pulmonary pressure. As compared to edematous fluid in pulmonary edema, pulmonary fluid in PINCPE may contain a higher amount of protein than in cardiogenic pulmonary edema [20]. In our study, CCBs causing PINCPE included amlodipine, verapamil and diltiazem, which act by blocking the flow of calcium at the level of the cell membrane in the cardiovascular system. Overdose of CCBs may increase prostacyclin synthesis in the vascular system causing precapillary vasodilation and excessive transudation in the pulmonary capillaries [6]. In cases of PINCPE, although we observed both atrioventricular block and bradycardia, ECG mainly indicated sinus tachycardia (50%). With regard to primary physiologic effects, amlodipine, a dihydropyridine type of CCB, reduces the rate of cardiac contraction and conduction by targeting the L-type channel and therefore, is useful in anti-hypertension treatment. However, overdose with dihydropyridine CCB is characterized by responsive tachycardia and strong positive inotropic effect due to drug properties of strong vascular selectivity and vasodilatory action.

Verapamil and diltiazem, members of the non-dihydropyridine class of CCB act at the level of both the myocardium and vascular membrane, but target the myocardium more selectively than the dihydropyridine type CCB. Verapamil and diltiazem are highly lipophilic agents that cause precapillary peripheral vasodilatation and decrease of cardiac contractility, which results in excess transudate in the capillaries of the lungs [6].

Hengameh H. et al. reported that narcotic analgesics, such as heroin, morphine, methadone, and meperidine are the most common drugs causing PINCPE [6]. In general, fatality cases due to heroin overdose present PINCPE as the main pathologic finding. Narcotic agents may increase permeability of the pulmonary capillaries and lower the left atrial pressure, which



can cause progression to coma due to hypoxemia. However, clinicians should be aware that the patient may not present typical clinical features of sedative toxidrome [20, 21]. Cooper et al. reported that the mechanism of PINCPPE due to narcotic use may be similar to that of neurogenic pulmonary edema due to high sympathetic discharge [4]. PINCPPE caused by overdose of salicylate and MDMA may involve the same mechanism as that of narcotic agent of over-production of catecholamine and adverse effects in the CNS and hypothalamus. Further venous return and hypoxemia cause pulmonary capillary constriction and loss of integrity of the vascular endothelium in the pulmonary system which results in PINCPPE [14, 22]. Patients with PINCPPE due to MDMA use may present elevated systemic blood pressure, and bradycardia reflex due to increase in interstitial fluid and alveolar transudate with capillary damage, which lead to hypoxemia by direct action of MDMA [22].

In our study, the younger group of <35.7 years achieved shorter LOS than the older group ( $5.7 \pm 1.7$  vs  $8.9 \pm 3.2$ ;  $p=0.022$ ), which may be due to the fact that LOS was prolonged in two of three cases with severe complication after intoxication in the older age group [23, 24]; the first case experienced severe metabolic acidosis and underwent treatment by emergent hemodialysis for 15 days, and the second case progressed to MOF after ingestion of organophosphate and expired 12 days later in the ICU. With regard to prognosis, PINCPPE cases showed a mortality rate of 12.5%, which is within the range of intra-hospital mortality rate of 2.1% to 21.9% in 32229 hospitalized patients with ADHF in a previous report [25].

## Conclusion

CCB was the most common agent causing PINCPPE. Up to 81.3% of PINCPPE cases required intubation with

mechanical ventilator support due to respiratory failure. Sinus tachycardia was the most common ECG finding (50%). LOS may increase 3.2 days in older group aged  $\geq 35.7$  years, if the case is complicated with extra-pulmonary organ failure.

## Limitations

Our study has some limitations. First, retrospective search of PubMed database may cause bias in sampling due to under-reported cases worldwide. Second, relatively small number of cases were enrolled which may cause difficulty in the normal distribution of data. Study including large number of cases of PINCPPE are required to confirm the result of the present study.

## Acknowledgements

We all thank Mr. Yi-Yo Shih in Shionogi's and Editage company for providing language help.

## Author contributions

Hsu C.C. Lin N.H., Yang H.W.: Data curation, writing – original draft preparation.

Su Y.J.: Conceptualization, methodology, formal analysis, writing – reviewing and editing.

## Conflict of Interest Statement

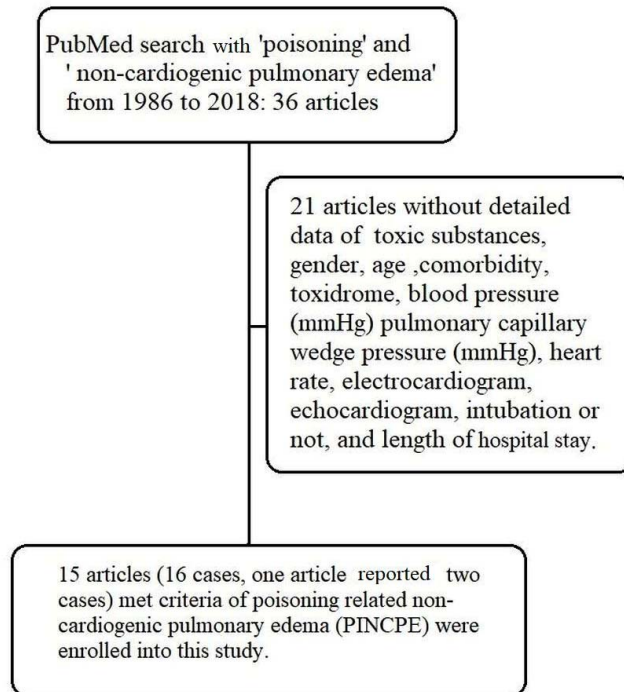
None declared.

**Funding source:** This research did not receive any specific grant from funding agencies in the public, commercial, or not-for-profit sectors.

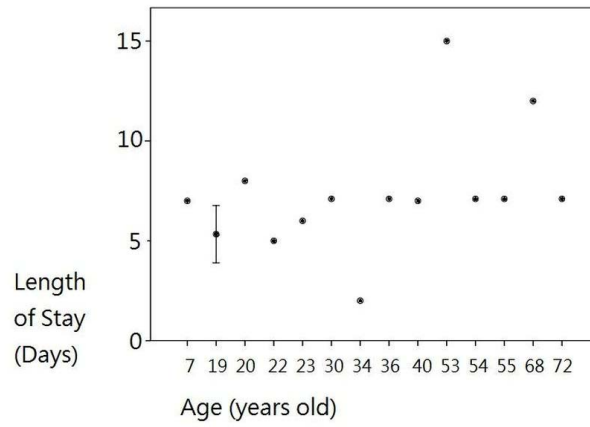
## References

1. Ware LB, Matthay MA. Clinical practice. Acute pulmonary edema. *N Engl J Med.* 2005;353(26):2788–96. <https://doi.org/10.1056/NEJMcp052699>
2. Gottlieb LS, Boylen TC. Pulmonary complications of drug abuse. *West J Med.* 1974;120:8–16.
3. Duberstein JL, Kaufman DM. A clinical study of an epidemic of heroin intoxication and heroin-induced pulmonary edema. *Am J Med.* 1971;51(6):704–14. [https://doi.org/10.1016/0002-9343\(71\)90298-1](https://doi.org/10.1016/0002-9343(71)90298-1)
4. Cooper JA Jr, White DA, Matthay RA. Drug-induced pulmonary disease. Part 2: Noncytotoxic drugs. *Am Rev Respir Dis.* 1986;133(3):488–505.
5. Low RI, Takeda P, Mason DT, DeMaria AN. The effects of calcium channel blocking agents on cardiovascular function. *Am J Cardiol.* 1982;49(3):547–53. [https://doi.org/10.1016/S0002-9149\(82\)80010-6](https://doi.org/10.1016/S0002-9149(82)80010-6)
6. Humbert VH Jr, Munn NJ, Hawkins RF. Noncardiogenic pulmonary edema complicating massive diltiazem overdose. *Chest.* 1991;99:258–9. <https://doi.org/10.1378/chest.99.1.258>

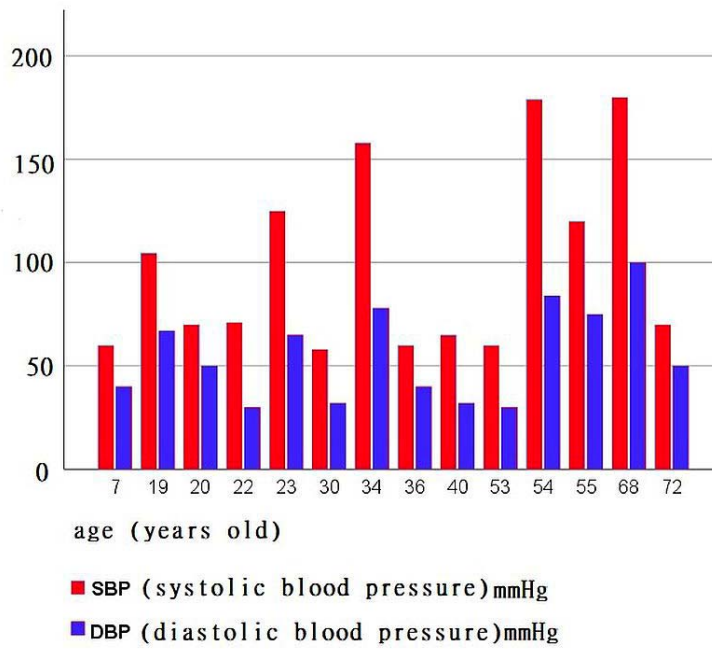
7. Fein A, Grossman RF, Jones JG, Overland E, Pitts L, Murray JF, et al. The value of edema fluid protein measurement in patients with pulmonary edema. *Am J Med.* 1979;67(1):32–8. [https://doi.org/10.1016/0002-9343\(79\)90066-4](https://doi.org/10.1016/0002-9343(79)90066-4)
8. Levitt JE, Vinayak AG, Gehlbach BK, Pohlman A, Van Cleve W, Hall JB, et al. Diagnostic utility of B-type natriuretic peptide in critically ill patients with pulmonary edema: a prospective cohort study. *Crit Care.* 2008;12(1):R3. <https://doi.org/10.1186/cc6764>
9. Sibbald WJ, Cunningham DR, Chin DN. Non-cardiac or cardiac pulmonary edema? A practical approach to clinical differentiation in critically ill patients. *Chest.* 1983;84(4):452–61. <https://doi.org/10.1378/chest.84.4.452>
10. Belice T, Yuce S, Kizilkaya B, Kurt A, Cure E. Noncardiac Pulmonary Edema induced by Sitagliptin Treatment. *J Family Med Prim Care.* 2014;3(4):456–7. <https://doi.org/10.4103/2249-4863.148149>
11. Dobbe L, Rahman R, Elmassry M, Paz P, Nugent K. Cardiogenic Pulmonary Edema. *Am J Med Sci.* 2019;358(6):389–97. <https://doi.org/10.1016/j.amjms.2019.09.011>
12. Givertz MM, Colucci WS, Braunwald E. Clinical aspects of heart failure; pulmonary edema, high-output failure. Zipes DP, Libby P, Bonow RO, Braunwald E, editors. *Heart disease: a textbook of cardiovascular medicine.* 7th ed. Philadelphia: Elsevier Saunders; 2004. p. 539.
13. Camus P, Bonniaud P, Fanton A, Camus C, Baudaun N, Foucher P. Drug-induced and iatrogenic infiltrative lung disease. *Clin Chest Med.* 2004;25(3):479–519, vi. <https://doi.org/10.1016/j.ccm.2004.05.006>
14. Yuklyayeva N, Chaudhary A, Gorantla R, Bischof E. Salicylate-induced pulmonary edema – a near-miss diagnosis. *Am J Emerg Med.* 2014;32(5):490.e5–6. <https://doi.org/10.1016/j.ajem.2013.11.021>
15. Thompson BT, Chambers RC, Liu KD. Acute Respiratory Distress Syndrome. *N Engl J Med.* 2017;377(6):562–72. <https://doi.org/10.1056/NEJMra1608077>
16. Clark SB, Soos MP. Noncardiogenic Pulmonary Edema. *StatPearls [Internet]. Treasure Island (FL): StatPearls Publishing; 2020.* [cited 2020 Oct 12]. Available from: <https://www.ncbi.nlm.nih.gov/books/NBK542230/>
17. Sporer KA, Dorn E. Heroin-related noncardiogenic pulmonary edema: a case series. *Chest.* 2001;120(5):1628–32. <https://doi.org/10.1378/chest.120.5.1628>
18. Sporer KA. Acute heroin overdose. *Ann Intern Med.* 1999;130(7):584–90. <https://doi.org/10.7326/0003-4819-130-7-199904060-00019>
19. Siddiqi TA, Hill J, Huckleberry Y, Parthasarathy S. Non-cardiogenic pulmonary edema and life-threatening shock due to calcium channel blocker overdose: a case report and clinical review. *Respir Care.* 2014;59(2):e15–21. <https://doi.org/10.4187/respcare.02244>
20. Keaney NP. Respiratory disorders. Davies DM, Ferner RE, Glanville H de, editors. *Textbook of Adverse Drug Reactions.* 5th ed. New York: Chapman & Hall Medical; 1998. p. 202–23.
21. Kakouros NS, Kakouros SN. Clinical Assessment in Acute Heart Failure. *Hellenic J Cardiol.* 2015;56(4):285–301.
22. Thakkar A, Parekh K, El Hachem K, Mohanraj EM. A Case of MDMA-Associated Cerebral and Pulmonary Edema Requiring ECMO. *Case Rep Crit Care.* 2017;2017:6417012. <https://doi.org/10.1155/2017/6417012>
23. Bauer P, Weber M, Mur JM, Protois JC, Bollaert PE, Condi A, et al. Transient non-cardiogenic pulmonary edema following massive ingestion of ethylene glycol butyl ether. *Intensive Care Med.* 1992;18(4):250–1. <https://doi.org/10.1007/BF01709843>
24. Betrosian A, Balla M, Kafiri G, Kofinas G, Makri R, Kakouri A. Multiple systems organ failure from organophosphate poisoning. *J Toxicol Clin Toxicol.* 1995;33(3):257–60. <https://doi.org/10.3109/15563659509017994>
25. Fonarow GC, Adams KF Jr, Abraham WT, Yancy CW, Boscardin WJ; ADHERE Scientific Advisory Committee, Study Group, and Investigators. Risk stratification for in-hospital mortality in acutely decompensated heart failure: classification and regression tree analysis. *JAMA.* 2005;293(5):572–80. <https://doi.org/10.1001/jama.293.5.572>

**Figures****Figure 1.** Process of case enrollment

**Figure 2.** Relationship between length of stay and age in poisoning induced non-cardiogenic pulmonary edema



**Figure 3.** Fluctuations of blood pressures to age relationship in non-cardiogenic lung edema cases



## Tables

**Table 1.** General data of 16 cases of poison induced non-cardiogenic pulmonary edema enrolled in the study

SEX (N, %)	Male (10, 62.5%); Female (6, 37.5%)
ELDERLY (N, %)	(2, 12.5%)
AGE (YEARS)	35.7±19.5
SYSTOLIC BLOOD PRESSURE (MMHG)	99.4±44.4
DIASTOLIC BLOOD PRESSURE (MMHG)	56.7±23.7
HEART RATE (BEATS/MIN)	87.9±34.4
ECG (N, %)	Sinus tachycardia (8, 50%) Sinus bradycardia (2, 12.5%) Normal sinus rhythm (2, 12.5%) First degree AVB (1, 6.25%) Third degree AVB (1, 6.25%) Not available (2, 12.5%)
TOXIDROME-SUBSTANCE (N, %)	
SYMPATHOLYTIC	CCB (8, 50%)
SYMPATHOMIMETIC	MDMA (1, 6.25%)
SEDATIVE-OPIOID	Methadone (1, 6.25%)
SEDATIVE-HYPNOTIC	Methaqualone (1, 6.25%)
CHOLINERGIC	Organophosphate (1, 6.25%)
ASPHYXIANT	Sodium azide (1, 6.25%)
MISCELLANEOUS	Salicylate acid (1, 6.25%) Anti-snake venom serum (1, 6.25%) Ethylene glycol (1, 6.25%)
INTUBATION WITH MV SUPPORT (N, %)	(13, 81.3%)
LOS (DAYS)	7.1±3.6
MORTALITY (N, %)	(2, 12.5%)

AVB = Atrioventricular block;  
ECG = Electrocardiogram;  
LOS = Length of stay;  
MV = Mechanical ventilator;  
CCB = Calcium channel blocker;  
MDMA = 3,4-methylenedioxy-methamphetamine.

**Table 2.** Distributions of the blood pressure, heart rate, and length of stay according to the age group.

	AGE (y)			Two-tailed p-value
	All	≥35.7	<35.7	
	Mean±SD (N)	Mean±SD (N)	Mean±SD (N)	
SBP (mmHg)	99.4±44.4 (16)	104.9±55.1 (7)	95.1±37.1 (9)	0.679
DBP (mmHg)	56.7±23.7 (16)	58.7±27.6 (7)	55.1±21.7 (9)	0.774
MAP (mmHg)	71.1±30	74.3±36.4 (7)	68.6±26.1 (9)	0.719
HR (beats/min)	87.9±34.4 (16)	92.4±31.8 (7)	84.4±37.8 (9)	0.661
LOS (days)	7.1±3.6 (11)	8.9±3.2 (3)	5.7±1.7 (8)	<b>0.022*</b>

	All	Male	Female	p-value
SBP (mmHg)	99.4±44.4 (16)	110.1±50.5	81.5±26.7	0.313
DBP (mmHg)	56.7±23.7 (16)	62±25.2	47.8±19.6	0.263
MAP (mmHg)	71.1±30	78.2±33.1	59.2±21.5	0.263
HR (beats/min)	87.9±34.4 (16)	107.3±23.5	55.7±23.6	<b>0.002*</b>
LOS (days)	7.1±3.6 (11)	7.8±	5.3±0.6	0.194

Due to small number of enrolled cases, Mann-Whitney U test was used for comparisons in mean age and gender.

SBP = Systolic blood pressure;

DBP = Diastolic blood pressure;

MBP = Mean blood pressure;

HR = Heart rate;

LOS = Length of stay.

N= available case number

\*indicates reaching statistical difference.



# MEDICAL PROFESSIONALISM PERCEPTION OF MEDICAL STUDENTS IN SPAIN

Blas Serrano-Costa<sup>1</sup>, Diego Flores-Funes<sup>2</sup>, Carmen Botella-Martínez<sup>3</sup>, Noemí M. Atucha<sup>4</sup>, Joaquín García-Estañ<sup>4\*</sup>

<sup>1</sup>Center of Studies On Medical Education, Universidad de Murcia, Murcia, Spain

<sup>2</sup>Center of Studies On Medical Education & Hospital Universitario Morales Meseguer, Murcia, Spain;

<sup>3</sup>Center of Studies On Medical Education & Hospital Clínico Universitario Virgen de la Arrixaca, Murcia, Spain

<sup>4</sup>Center of Studies On Medical Education, Universidad de Murcia, Murcia, Spain

## Abstract

**Introduction:** Currently, the Doctor-Patient relationship of all cultures and societies is in crisis due to the distrust that has arisen in this social contract. This distrust originates from various changes that have occurred worldwide. We, as doctors, can contribute to solving this crisis, reaffirming the values that integrate medical professionalism. In the absence of specific studies and programmes on medical professionalism in Spanish universities, we consider knowing the perception of medical professionalism by medical students at the University of Murcia essential to see if there is a need to introduce educational improvements in our faculty.

**Methods:** A professionalism questionnaire from the Penn State University School of Medicine (PSCOM) was provided online, voluntarily and anonymously to all students of the Medicine degree of the University of Murcia.

**Results:** The perception of professionalism in students was high, since all categories have more than 75% positive responses on average. The categories of Respect and Altruism were the best rated. On the other hand, there is a slight increase in negative responses as students progress through the degree. Between sexes, however, there were no differences in the criteria.

**Conclusions:** Although the perception of professionalism is good, it is still a perception, so it should reach values closer to 100%. Therefore, the faculty is encouraged to carry out specific programmes to promote medical professionalism in the degree courses.

## Keywords

Medical education • Medical ethics • Medical professionalism • Medicine students • Education in professionalism

## Introduction

The practice of Medicine is currently facing a crisis, in all cultures and societies, that threatens its principles and deteriorates the doctor-patient and medicine-society relationships. An increased demand for services, fewer physicians providing comprehensive coordinated services, an aging population with more chronic disease and the privatization of medical services, among others, threaten the provision of altruistic care. As a consequence of this crisis, the social contract that Medicine has with the society is at risk [1]. For many, the only solution is in medical professionalism, in which doctors reaffirm their active vocation for the principles of professionalism [2]. Professionalism is essential in medical practice. It is the basis on which the relationship with both the patient and the society is built. As many studies have shown [3], its proper application has led to improvements in doctor-patient and doctor-society relationships, patient satisfaction has increased, professional satisfaction in

healthcare professionals has increased, and healthcare has become more effective and efficient.

Since professionalism is a complex and multidimensional social construction, there is no universally accepted definition. There are authors who affirm that the beauty of professionalism lies precisely in its lack of definition, because it makes it a flexible concept that can be applied to a wide variety of situations. However, it seems that instead of being used flexibly and applied to solve the crisis of the social contract, the lack of definition of professionalism contributes to the permanence of this crisis [4]. Others think that a definition is necessary [5] and that it should include its interpretation at a specific time, place, context and culture. Therefore, each place must have its own definition of medical professionalism changing over time and depending on the social and cultural contexts [6]. In addition, it has to be a definition not elaborated only by the doctors of the

area, but also by the rest of the health personnel, patients and medical students. Currently, the most conventional definition of professionalism is the one provided by the “Medical Professionalism Project” carried out by the European Federation of Internal Medicine, the ACP-ASIM Foundation (American College of Physicians-American Society of Internal Medicine) and the ABIM Foundation (American Committee of Internal Medicine). This definition includes three fundamental principles and a compendium of ten commitments (duties and obligations) that the doctor undertakes to fulfil before himself, the patient and the society [2]. Its fundamental principles are the “Principle of primacy of patient well-being”, the “Principle of patient autonomy” and the “Principle of social justice”. In Spain, the General Council of Medical Colleges (CGCOM) approved a definition aimed not only at Spanish doctors, but also at medical students [7] on which other Spanish authors have published interesting studies [8, 9].

Medical students, as part of the society and part of the medical team in clinical practices, have also experienced the causes and consequences of the crisis of the social contract between Medicine and Society. Papadakis et al. [10] published a study showing that inappropriate professional behaviours for which some doctors were reported consisted with the same behaviours that these doctors had had during their training in the faculty. It seems therefore that it is insufficient for the student to acquire by osmosis the principles that the professional shows them during their practices (hidden curriculum). This passive form of learning is not enough for the student to learn professionalism correctly [11]. In addition, there is no consensus on a theoretical and practical model of this to integrate it into medical education [5] since although professionalism is one of the most difficult skills to define, teach and evaluate, it is also true that we do not give it adequate attention, being good proof of this both the lack of commented consensus and the limited number of investigations for its application in medical teaching [6]. Unfortunately, there are no studies that show what Spanish medical students think about medical professionalism.

In an attempt to contribute to remediating the deficiencies described, we set out to analyse the perception of medical professionalism by medical students at one of our universities. The results will be compared with those of other countries as well as analysing whether it is necessary to establish new measures in order to make improvements in medical education in our setting.

## Methods

The study was conducted as a cross-sectional study and it was approved by the Research Ethics Committee of the

University of Murcia. To meet the objective, we have used the Professionalism questionnaire from the Penn State University School of Medicine (PSCOM), a scale that has solid internal validity evidence, being a good tool to assess professionalism in medical students [12]. In our case, we did not use the original version but the adaptation to the Spanish language made by Bustamante and Sanabria [13], with minimal changes to adapt it to Spanish from Spain (Table 1). It consists of 6 blocks, each of which presents 6 attitudes that represent an element of medical professionalism defined by ABIM, namely: responsibility, altruism, service, excellence, honesty and integrity, and respect [12]. Firstly, the respondents were asked to order the attitudes according to the frequency of their compliance with these attitudes (5-point Likert scale: “Never, Little, Sometimes, Frequently, and Always”). Secondly, the respondents were asked to put the attitudes in order of importance (with 1 being the attitude considered most important of the block and 6 the least important) [11]. The survey was conducted online in February 2019 through a Google form sent by email to all Medicine students at the University of Murcia, of the six years of study. Participation was voluntary and anonymous. In order to analyse the collected data, the following procedure was performed.

Firstly, we converted the answers given to different questions on the Likert scale into numerical data to allow for carrying out descriptive statistics (Never = 0, Little = 1, Sometimes = 2, Frequently = 3, Always = 4). After calculating the descriptive statistics, it was observed that the data did not follow a normal distribution. In view of this, the vast majority of the statistics were carried out with non-parametric tests. To compare the categories between the courses, the Kruskal-Wallis test was used. And to compare the categories within each course, we used the Friedman test. In the same way, the Mann-Whitney test was used to compare categories between sexes.

Secondly, the data was grouped into negative and positive responses. For this, a recategorisation was made, assigning the responses “never”, “little” and “sometimes” as negative, and the responses “frequently” and “always” as positive. Finally, a linear regression analysis was performed to analyse the relationship between positive-negative responses and years of study.

## Results

The number of survey participants was 179 out of a total of 1,200 officially enrolled students (15.25%). Of those 179, 69 were men (38.54%) and the rest (61.46%) were women. Cronbach’s alpha for each category was greater than 0.70, indicating a high internal consistency and reliability of the survey. The global alpha was  $0.78 \pm 0.02$ .

Although in almost all the comparisons between the courses there were significant differences, they were between very close values, such as 4.3 and 4.5. This is most likely due to a relatively large sample and, therefore, when there are minimal differences, statistical tests characterise them as significant. These differences can be better understood by looking at the graphically represented responses (Figure 1).

Secondly, there were no differences between sexes. There was also a slight tendency to evaluate the categories in the upper grades worse (the six-year students evaluated the categories worse than those in the first year). As it is shown in Figure 2, the percentage of positive responses obtained in relation to the maximum possible (100%) was quite high, going from practically 75% upwards in all categories.

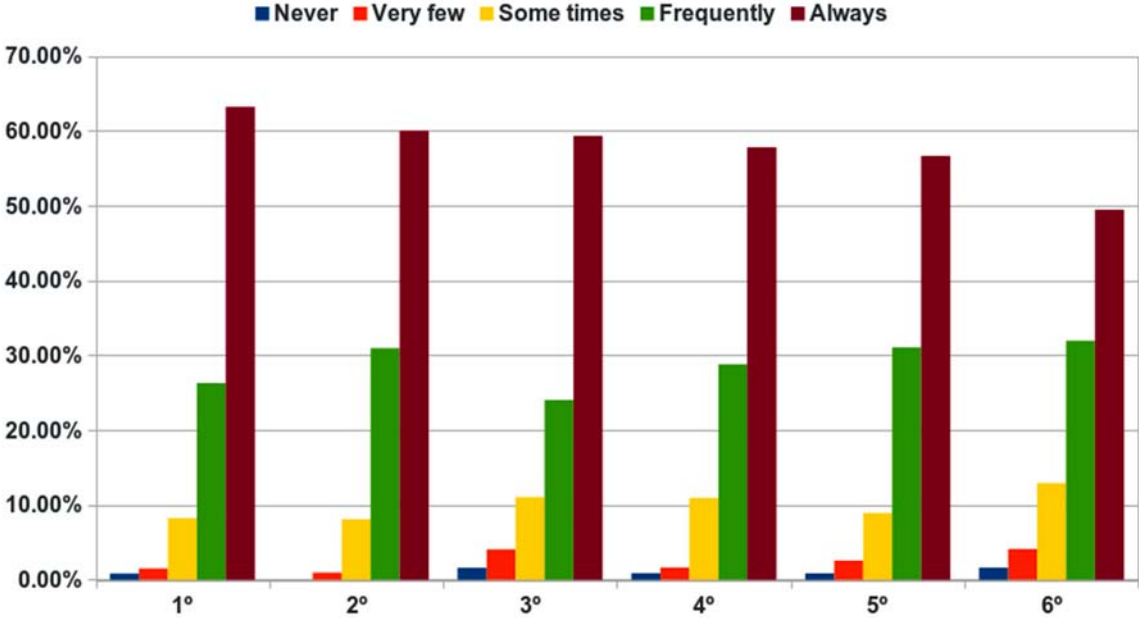


Figure 1. Percentage of answers to the survey questions in every course

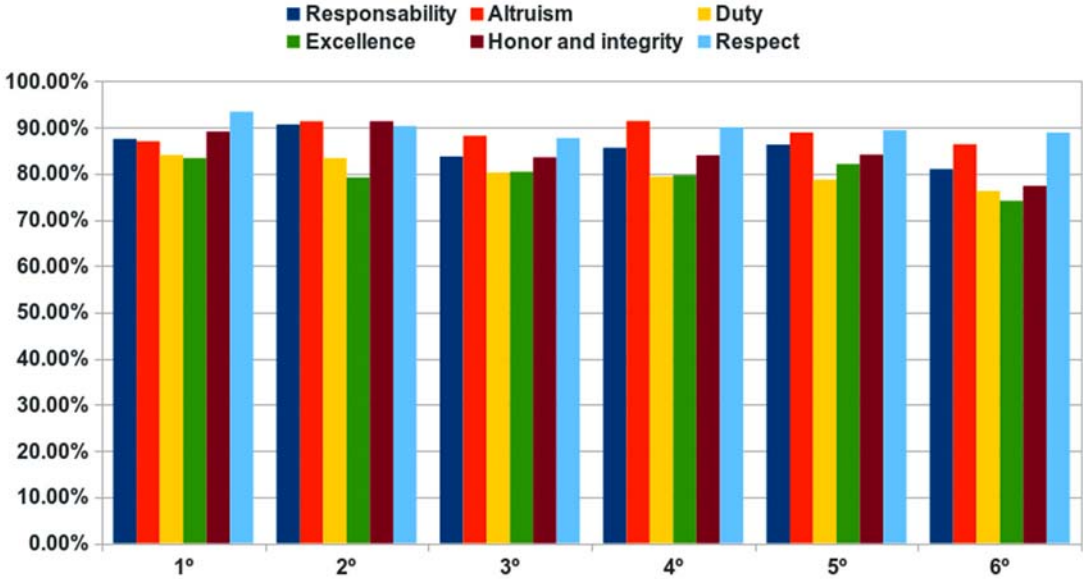


Figure 2. Mean percentage of professionalism categories in every course

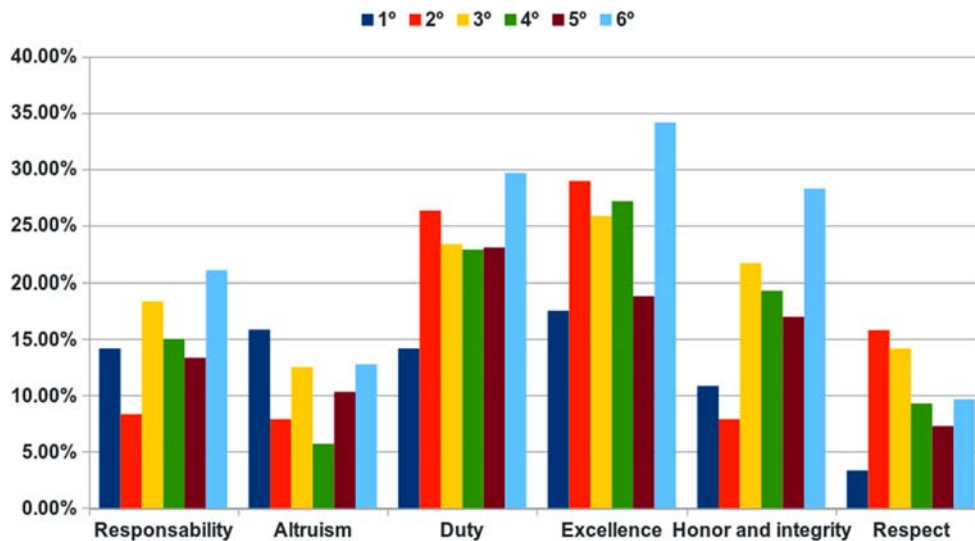


Figure 3. Percentage of negative answers by category and course

Figure 3 shows the percentage of negative responses obtained by category and course. As we can see, the sixth course was the one that presented the most negative responses in all domains, except in two of them, Altruism and Respect. On the other hand, the first course was the one with the least negative responses, except for Responsibility, Altruism and Honour and Integrity. However, we observed that the number of negative responses was greater in the “clinical” courses (4th to 6th), except for the domains of Altruism and Respect.

In addition, the Honour and Integrity domain was the one that presented the greatest difference in negative responses

between the “non-clinical” (1st to 3rd) and “clinical” courses, being 8.05% higher in the “clinical” compared to the “non-clinical” stage of medical education. The category that was best valued and, therefore, had a higher average of positive responses is Respect, with 90.34% of positive responses. The least valued category was Excellence with 74.61%. Regarding the year of study, the one with the most negative responses was the sixth, with an average of 22.59% while the course that showed the least negative responses was the first one, with an average of 12.64%. The global average of the “non-clinical” courses was 15.94% and that of the “clinical” courses is 19.03%.

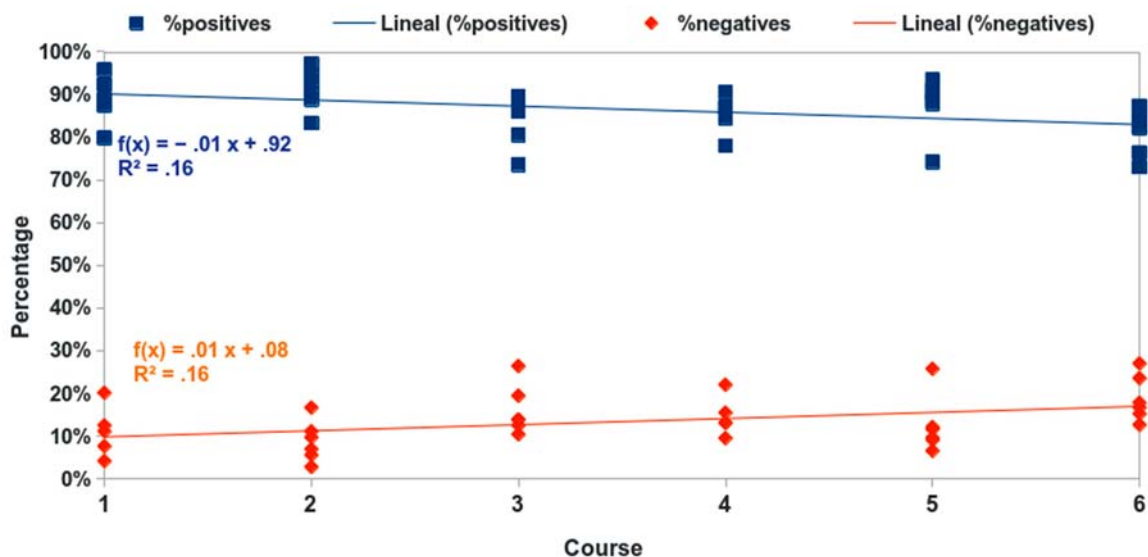


Figure 4. Linear regression of positive and negative answers

Figure 4 shows linear regression, which turned out to be statistically significant, between negative responses and the grade (negative responses increase with courses and positive responses decrease). However, it must be clarified that the relationship between variables is small, since the correlation coefficient is 0.40. This regression confirms the slight tendency that negative responses have to increase with the courses and that we have observed in the figures and tables above.

Finally, Figures 5 and 6 show the order of importance given by the students to the different categories in each of the courses. In both men (Figure 6) and women (Figure 7), the domain considered most important was Altruism (2.89 in men in women) and the least important was Excellence (3.73 in men and 3.95 in women).

## Discussion

Medical schools often assume that the students who enter medical studies improve their ethical values as they advance through the courses since they have included professionalism in subject competences and, in addition, the students learn by imitation of the professionals in clinical practices. However, studies carried out for three decades demonstrate the opposite, that is, a negative trend in ethical progress during the Medicine career [14-17] and some speak of the moral principles of the students being “eroded” or lost during the stay in the faculty (18-20).

Faced with this situation, Blackall et al. validated in 2007 an instrument to measure professionalism in medical students, the PSCOM scale used in this study [21]. Using the original version of this scale in English, various studies have been conducted [14, 22, 23]. In these works, differences between young and veteran students could be observed. In our language, only the aforementioned article by Bustamante and Sanabria, in Colombia, who adapted the original to Spanish in 2014 [13], can be cited as a reference. In both studies, those of these authors and ours, there is a predominance of positive responses, so that it could be considered that there is a good perception of medical professionalism in medical students. The category best valued by both Colombian students and those of our faculty is Respect, with an average of positive responses of 75.5% for Colombian students [13] and 90.08% for those of our university. As we can see, for the students of both universities, the most important thing is to respect the nature of the patient, his autonomy and his confidentiality.

In the article by Bustamante and Sanabria [13], we can see that more negative responses (17.35%) were collected in the clinical courses of the degree compared to non-clinical courses (15.91%). When analysing each of the domains, they observed that all of them had more negative responses in the clinical courses, except in the category of Responsibility. In our work, we confirm these data since we have verified that there is a positive correlation between the negative responses and the course, in such a way that the negative responses are greater as the course increases. When we look at the number of negative responses per course, we

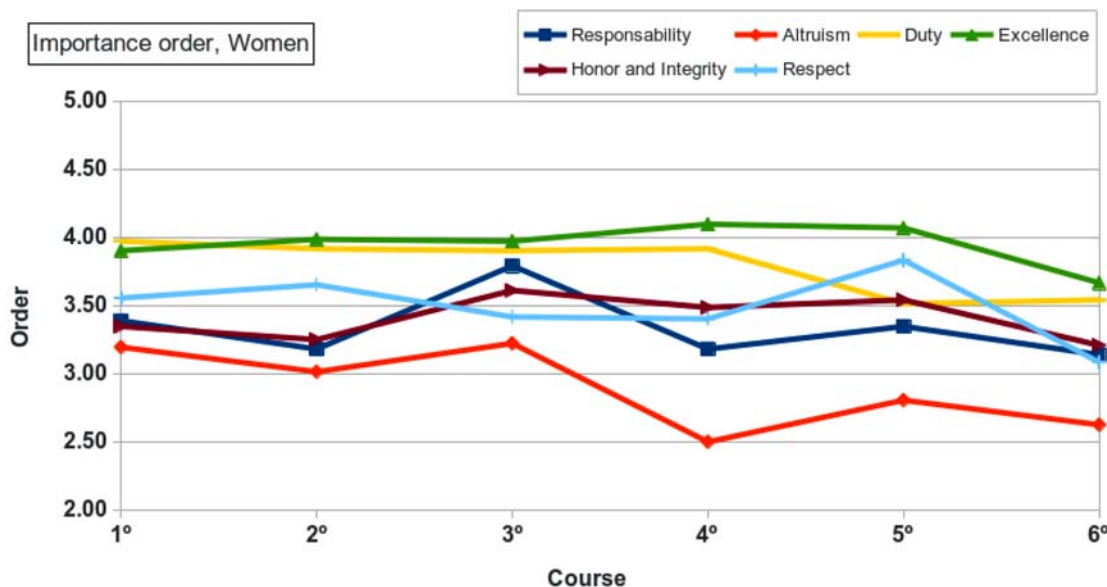


Figure 5. Importance order of categories in women

see that the course with the most negative responses is the sixth and the least negative is the first. Furthermore, if we look at the negative response means, we also see that it is higher in clinical courses (19.03% vs 15.93% in non-clinical courses). As we can see, the Excellence domain is the one with the highest number of negative responses. This means that the medical students of Murcia do not think that the most important thing in patient care is personal improvement. This may be due to their very own experience as students. On the other hand, observing the results, we revealed their similarities with the results of the research describing the perceptions of students from Colombia: the students of our faculty also consider participation in the development of medical education to be less important. This is observed when verifying that one of the items with the most negative responses is also “Attend faculty meetings, seminars and presentations of student research as a demonstration of support” (from the Duty category).

Many authors have wondered about the causes of this decrease in ethical values during the stay in the medical school [24]. Coulehan, Williams, and Halpern in 2001 stated that Evidence-Based Medicine is making students themselves less emotionally involved with patients [25]. In 2008 Newton et al [19] explain that it may be due to test anxiety, lack of sleep, difficulties in communicating with patients, as well as the creation of interpersonal relationships in the hospital. Other authors [26] reflect on a deficient role of universities to encourage a good ethical response from students and the unethical behaviours the students may observe in some of their teachers, such as authoritarianism, competition for money, prestige, positions of power, etc.

Another aspect to take into account is that, through the classification of items in order of importance, we have observed that the Altruism domain is the most valued of all, both by grade and by sex. In the study by Bustamante and Sanabria, it is not specified which domain is the best rated one, despite the fact that it also uses the scale it measures in order of importance, and it does not make a distinction by sex as in our study.

In our study, an attempt was made to inquire about this question by asking the students in the survey whether they had less desire to be doctors in comparison with the beginning of their degree. Of the 179 respondents, 35 students (almost 20%) answered that they had less desire. The most frequent reason that students attributed to their “lower desire” to be doctors (with 16 responses out of 35) was the “bad approach to the degree”, meaning the students have too many difficult subjects to master, which makes it impossible to learn them properly and to enjoy learning. In fact, many emphasised that the university does not teach or assess knowledge adequately, commenting that everything revolves around theoretical knowledge and that, therefore, the degree has become a “process of passing exams” for obtaining the diploma. In addition, since the studies last so long, a great effort for a long time leads to demotivation and even to exhaustion (burnout).

Among the limitations of the present study, we must mention the PSCOM scale itself, which measures perception. However, carrying out studies based on the measurement of student actions is not easy or without risks [3]. The voluntary nature of the survey may also suggest that the students who respond may be more motivated than those who do not [13].

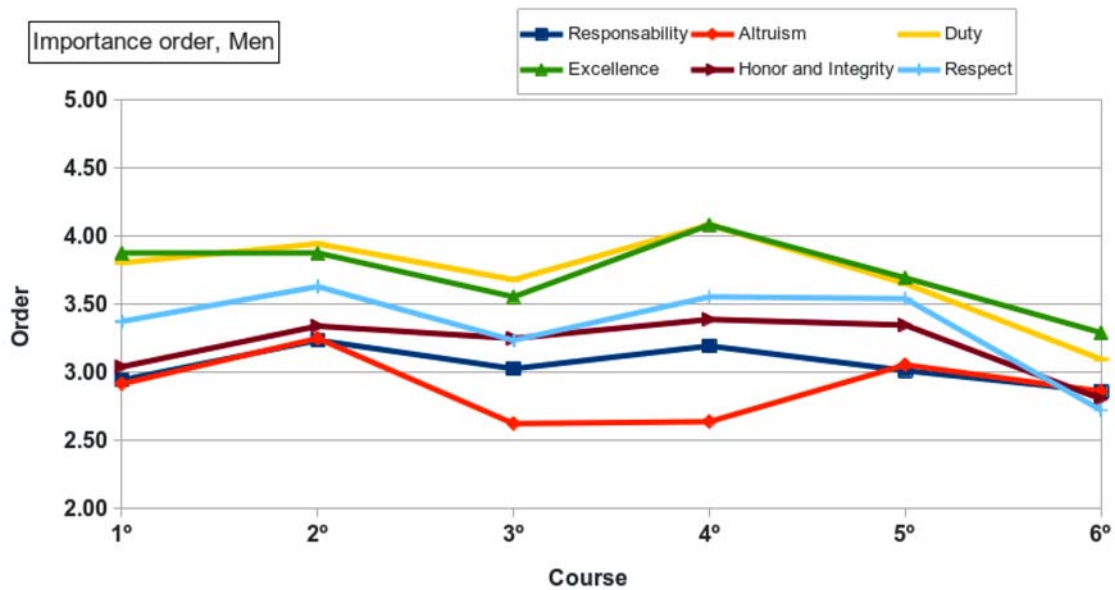


Figure 6. Importance order of categories in men.



These two aspects would tend to show more positive results of professionalism than the real ones. Another limitation is the type of study, since we have measured professionalism at a certain time (cross-sectional study) and the most appropriate would be to carry out a longitudinal study, in order to monitor changes in the perception of professionalism [3]. Also, we have analyzed the topic in only one of our medical schools in Spain. However, we believe that the results and conclusions may be valid for the rest of the country due to the uniformity of the medical degrees in Spain. Thus, we follow the same Medical Degree curriculum, after a mandatory government-issued national law, the same national professors selection methods and hospital dependence of national and autonomic health systems; maybe, with only some differences among public and private universities. Clearly, it is our intention to analyze the perception of professionalism in the rest of medical schools in the country, as well as to follow its evolution with time.

Finally, despite the fact that the perception of professionalism is good, it should not be forgotten that it is only a perception and that it should be even closer to 100% values. Therefore, the faculty must be encouraged to make specific programmes to improve professionalism in their students, since a good doctor, to be a good professional, must not only have theoretical and practical knowledge, but also proper ethical values. For this, it would be important to make a specific definition about professionalism or, in any case, follow the proposal by CGCOM [7]. It would also be interesting to include the teaching of professionalism in the programme of all the degree courses, so that it would not only be acquired in clinical practice but also theoretically known [11]. Regarding clinical practice, more should be done to teach professionalism by clinical teachers and tutors, as well as instilling the student to reflect on it in their professional experiences. Some authors even say that learning is not only “top down”, that is, from doctor to student, but also “bottom up”, from student to doctor [5]. Therefore, all the non-professional behaviours of the student or the doctor that are appreciated in the clinical practice, should be reported, in order to be remedied. Finally, teachers must

evaluate the learning of professionalism by students and check the acquisition of values. Professionals must also be adequately trained, that is, the teacher must be trained to teach professionalism, especially to apply techniques that allow the student to reflect on what is considered [5].

## Conclusion

The perception of medical professionalism that the students of the Faculty of Medicine of Murcia have, in general, is good, with an average of over 75% of positive responses for each category.

There are statistically significant differences between the courses, although of little relevance because the median of the answers is concentrated in a small numerical interval (between 4.3 and 4.5).

A correlation is observed between the negative responses and the courses. Although it is not a very high relationship, this indicates that clinical courses have more negative responses (19.03%) than non-clinical courses (15.93%). Some students of our faculty attribute this fact to the “bad approach to the career” since they consider that it presents a too extensive and difficult subject, that is not taught properly and that requires a great effort for a long time. This suggests that students may feel demotivation and even burnout that lead them to value professionalism lower with the passing of the courses.

The best valued domain is Respect and the best valued category is Altruism. On the other hand, the domain with the most negative responses on both scales is Excellence.

Acknowledgements: To all students that participated in the survey.

## Conflict of Interest Statement

No interest was declared. No funding was received.

## References

1. Hood VL. Medical professionalism faces new challenges, opportunities [Internet]. ACP Internist; 2012. [cited 2020 Nov 01]. Available from: <https://acpinternist.org/archives/2012/01/presidents.htm>
2. ABIM Foundation. American Board of Internal Medicine; ACP–ASIM Foundation. American College of Physicians–American Society of Internal Medicine; European Federation of Internal Medicine. Medical professionalism in the new millennium: a physician charter. *Ann Intern Med.* 2002;136(3):243-6. <https://doi.org/10.7326/0003-4819-136-3-200202050-00012>

3. Li H, Ding N, Zhang Y, Liu Y, Wen D. Assessing medical professionalism: A systematic review of instruments and their measurement properties. *PLoS One*. 2017;12(5):e0177321. <https://doi.org/10.1371/journal.pone.0177321>
4. Lee JH. The Weaponization of Medical Professionalism. *Acad Med*. 2017;92(2):579-80. <https://doi.org/10.1097/ACM.0000000000001647>
5. Birden H, Glass N, Wilson I, Harrison M, Usherwood T, Nass D. Teaching professionalism in medical education: a Best Evidence Medical Education (BEME) systematic review. BEME Guide No. 25. *Med Teach*. 2013;35(7):e1252-66. <https://doi.org/10.3109/0142159X.2013.789132>
6. Al-Eraky MM. Twelve Tips for teaching medical professionalism at all levels of medical education. *Med Teach*. 2015;37(11):1018-25. <https://doi.org/10.3109/0142159X.2015.1020288>
7. Medical profession. Medical professional. Medical professionalism. Organización Médica Colegial de España; 2010. p. 1-30. Spanish. [cited 2020 Nov 01]. Available from: [https://www.educacionmedica.net/pdf/documentos/omc/definiciones\\_profesional\\_2010.pdf](https://www.educacionmedica.net/pdf/documentos/omc/definiciones_profesional_2010.pdf)
8. Merino J. Profesionalismo o profesionalidad médica. *Educ Med*. 2015;16(1):29-32. Spanish.
9. Millán Núñez-Cortés J. Physician's values for quality practice: professionalism. *FEM*. 2014;17(Suppl 1):S1-47. Spanish. [cited 2020 Nov 01]. Available from: [http://scielo.isciii.es/scielo.php?script=sci\\_arttext&pid=S2014-98322014000500003](http://scielo.isciii.es/scielo.php?script=sci_arttext&pid=S2014-98322014000500003)
10. Papadakis MA, Hodgson CS, Teherani A, Kohatsu ND. Unprofessional behavior in medical school is associated with subsequent disciplinary action by a state medical board. *Acad Med* 2004;79(3):244-9.
11. Roberts TE. Teaching, learning and evaluating professionalism: the greatest challenge of all. *FEM*. 2017;20(2):47-51. Spanish. [cited 2020 Nov 01]. Available from: [http://scielo.isciii.es/scielo.php?script=sci\\_abstract&pid=S2014-98322017000200002](http://scielo.isciii.es/scielo.php?script=sci_abstract&pid=S2014-98322017000200002)
12. Davis K, Reyes A. Critical Synthesis Package: Penn State College of Medicine Professionalism Questionnaire. *MedEdPORTAL* 2015;11(10). [https://doi.org/10.15766/mep\\_2374-8265.10235](https://doi.org/10.15766/mep_2374-8265.10235)
13. Bustamante E, Sanabria A. Evaluation of attitudes towards professionalism in medical students. *Rev Colomb Cir*. 2014;29(1):222-29. Spanish. [cited 2020 Nov 01]. Available from: <http://www.scielo.org.co/pdf/rcci/v29n3/v29n3a7.pdf>
14. Govindaraja C, Ramachandran G, Ko Ko Min A. The Ecology of Medical Professionalism: Perceived and Emulated, What matters? *MedEdPublish*. 2016;5(3):11. <https://doi.org/10.15694/mep.2016.000097>
15. Smith R. Medical professionalism: a key to a better health system and more satisfied doctors. *BMJ Blogs* [Internet] 2018. [cited 2020 Nov 01]. Available from: <https://blogs.bmj.com/bmj/2018/12/06/medical-professionalism-a-key-to-a-better-health-system-and-more-satisfied-doctors/>
16. Morales-Ruiz J. Comprehensive training and medical professionalism: a proposal for work in the classroom. *Educ Med*. 2009;12(2):73-82. Spanish. [cited 2020 Nov 01]. Available from: <http://scielo.isciii.es/pdf/edu/v12n2/colaboracion2.pdf>
17. Yavari N. Does medical education erode medical trainees' ethical attitude and behavior? *J Med Ethics Hist Med*. 2016;9:16.
18. Mak-van der Vossen M, van Mook W, van der Burgt S, Kors J, Ket JCF, Croiset G, et al. Descriptors for unprofessional behaviours of medical students: a systematic review and categorisation. *BMC Med Educ*. 2017;17(1):164. <https://doi.org/10.1186/s12909-017-0997-x>
19. Newton BW, Barber L, Clardy J, Cleveland E, O'Sullivan P. Is there hardening of the heart during medical school? *Acad Med*. 2008;83(3):244-9. <https://doi.org/10.1097/ACM.0b013e3181637837>
20. Rosenthal S, Howard B, Schlüssel YR, Herrigel D, Smolarz BG, Gable B, et al. Humanism at heart: preserving empathy in third-year medical students. *Acad Med*. 2011;86(3):350-8. <https://doi.org/10.1097/ACM.0b013e318209897f>
21. Blackall GF, Melnick SA, Shoop GH, George J, Lerner SM, Wilson PK, et al. Professionalism in medical education: the development and validation of a survey instrument to assess attitudes toward professionalism. *Med Teach*. 2007;29(2-3):e58-62. <https://doi.org/10.1080/01421590601044984>
22. Pearson WG Jr, Hoagland TM. Measuring change in professionalism attitudes during the gross anatomy course. *Anat Sci Educ*. 2010;3(1):12-6. <https://doi.org/10.1002/ase.113>
23. Akhund S, Shaikh ZA, Ali SA. Attitudes of Pakistani and Pakistani heritage medical students regarding professionalism at a medical college in Karachi, Pakistan. *BMC Res Notes*. 2014;7:150. <https://doi.org/10.1186/1756-0500-7-150>
24. Brown ME, Coker O, Heybourne A, Finn GM. Exploring the Hidden Curriculum's Impact on Medical Students: Professionalism, Identity Formation and the Need for Transparency. *Med Sci Educ*. 2020;30(3):1107-21. <https://doi.org/10.1007/s40670-020-01021-z>
25. Coulehan J, Williams PC. Vanquishing virtue: the impact of medical education. *Acad Med*. 2001;76(6):598-605. <https://doi.org/10.1097/00001888-200106000-00008>
26. AlMahmoud T, Hashim MJ, Elzubeir MA, Branicki F. Ethics teaching in a medical education environment: preferences for diversity of learning and assessment methods. *Med Educ Online*. 2017;22(1):1328257. <http://doi.org/10.1080/10872981.2017.1328257>

## Tables

**Table 1.** Complete PSCOM survey (slightly adapted from Bustamante and Sanabria (13).

### 1. Responsibility

- Maintains scientific standards and bases his/her decisions on scientific evidence and experience.
- Works respectfully in collaboration with the team (of peers) for the benefit of providing better patient care or as a contribution to research
- Participates in corrective action processes against those who fail to meet standards of professional conduct.
- Recognizes his/her own limitations.
- Assumes his/her own personal responsibility in making decisions about patient care.
- Presents information and acts honestly.

### 2. Altruism

- Maintains doctor-patient relationships without seeking personal financial, privacy or sexual advantage.
- Shows interest in initiating and offering assistance for the professional and personal development of a partner
- Does not seek career advancement at the expense of others
- Manifests compassion.
- Demonstrates empathy.
- Defends the interests of the patient or research subject above personal interest.

### 3. Duty

- Takes time to review the work of colleagues and provide meaningful and constructive comments and suggestions for improvement.
- Attends faculty meetings, seminars and presentations of student research as a demonstration of support.
- Volunteers her experience and skills for the well-being of the community.
- Demonstrates adaptability in responding to changing needs and priorities.
- Adopts uniform and equitable standards of patient care
- Is committed to implementing cost-effective patient care.

### 4. Excellence

- Seeks personal improvement.
- Promotes the well-being and development of young teachers.
- Contributes significantly to the teaching mission of the department and the School of Medicine
- Assumes leadership in patient management
- Participates in activities focused on achieving excellence in patient care.
- Responds to constructive criticism by seeking to improve his/her skills in the area being criticized.

### 5. Honour and integrity

- Transmits information in a consistent, accurate and honest manner.
- Refuses to break its own personal and professional code of conduct.
- Complies with its obligations and commitments in a serious manner.
- Promotes justice within the health care system by demonstrating efforts to eliminate discrimination within the system.
- Report medical or research errors.
- Discloses conflicts of interest in the performance of professional duties and activities.

### 6. Respect

- Avoid making offensive comments and indelicate or unfair criticism of other classmates.
- Appreciates and respects the diverse nature of research subjects or patients and honors those differences in their work.
- Respects the rights, individuality, and diversity of thought of colleagues and students.
- Respects the autonomy of patients and helps them make informed decisions.
- Your behaviour demonstrates commitment to confidentiality.
- Dresses professionally and respectfully towards others.

# LONG-TERM FOLLOW-UP OF DENTAL REHABILITATION OF A PATIENT WITH CLOUSTON SYNDROME AND CONGENITAL EDENTULISM (ISSUES OF THEORY AND CLINICAL PRACTICE)

V.G. Galonsky<sup>1,3,4</sup>, N.V. Tarasova<sup>3</sup>, V.N. Chernov<sup>2</sup>, M.Yu. Makarchuk<sup>1</sup>, A.V. Gradoboev<sup>5</sup>

<sup>1</sup>Department of paediatric dentistry and orthodontics, FSBEI HE Prov. V.F. Voino-Yasenetsky Krasnoyarsk State Medical University, Krasnoyarsk, Russian Federation

<sup>2</sup>Department of orthopaedic dentistry, FSBEI HE Prov. V.F. Voino-Yasenetsky Krasnoyarsk State Medical University, Krasnoyarsk, Russian Federation

<sup>3</sup>Department of dentistry at the Institute of Postgraduate Education, FSBEI HE Prov. V.F. Voino-Yasenetsky Krasnoyarsk State Medical University, Krasnoyarsk, Russian Federation

<sup>4</sup>Siberian Branch of the Russian Academy of Sciences Krasnoyarsk Scientific Center, Research Institute for Medical Problems of Northern Regions, Krasnoyarsk, Russian Federation

<sup>5</sup>Dental Clinic "Helios" LLC, Sharypovo, Russian Federation

## Abstract

The article presents results of a concise analysis of domestic and foreign literature addressing the problem of determining of distinctive diagnostic features in patients with Clouston syndrome as an orphan disease rarely encountered in clinical practice of dentistry. A clinical case of effective orthopaedic rehabilitation of a 10-years-old patient with Clouston syndrome and congenital edentulism using minimally invasive orthopaedic dentistry measures: removable dentures application using shape memory materials is presented. Technological peculiarities and advantages of the chosen approach to treatment are described. Photographic documents of orthopaedic dental treatment results including long-term results within the follow-up period of 10 years are presented providing strong evidence of effective aesthetic, functional and social rehabilitation of the patient. Detailed analytical conclusion is drawn according to the study results.

## Keywords

Clouston syndrome • ectodermal dysplasia • hidrotic ectodermal dysplasia • congenital edentulism • orthopaedic dental treatment • removable dentures • orphan diseases • shape memory materials • titanium nickelide

## Introduction

Clouston syndrome (synonym: hidrotic ectodermal dysplasia) is an extremely rare hereditary genetic disorder related to a wide array of congenital pathologies – ectodermal dysplasias. This disease, as opposed to the anhidrotic form (Christ-Siemens-Touraine syndrome), is less frequently diagnosed in clinical practice and leads to a lower degree of abnormal development of ectodermal germ layer derivatives: skin cover, hair, perspiratory glands, nails, teeth and other organs and systems of ectodermal origin [1-5].

Clouston syndrome is on the list of rare (orphan) diseases. This group of nosological entities includes congenital and hereditary diseases, the frequency of which does not exceed a certain value defined by legal acts. Thus, prevalence of rare diseases in 10,000 of the population totals 7.5 in the

USA, 4.0 in Japan, 1.1 in Australia, 5.0 in the EU, 0.18 in Great Britain according to normative legal documents of the respective countries.

In the Russian Federation (RF), the frequency criterion of incidence is defined as 10 cases in 100,000 of the population according to the Federal Law dated November 21, 2011 No.323-FZ "On Fundamentals of Healthcare of the Citizens in the Russian Federation". The expected number of Clouston syndrome patients (in 1.7mil of newborns) in the RF totals 1-2 clinical cases. In the RF, the problem of rare disease diagnosis becomes ever more relevant. Therewith, practicing physicians are insufficiently informed about orphan diseases. In educational and scientific literature, little attention is devoted to the problem of such diseases.

The factors prohibiting effective solution of orphan disease clinical problems are the following:

1. Low occurrence of orphan diseases and syndrome in clinical practice
2. Difficulty in diagnosis, lack or unavailability of diagnosis verification in the conditions of actual clinical practice
3. As a rule, late diagnosis of the pathology in an older age group, not in the childhood
4. Oftentimes, in over 40% of the clinical cases, erroneous diagnosis is established
5. Absence of approved clinical guidelines for treatment of orphan disease patients, including such guidelines for single-discipline specialists, with absence of continuity and complementarity of such guidelines in outpatient and inpatient clinical practice
6. Difficult social consequences of orphan diseases in absence of timely treatment provision
7. Low quality of medical service
8. Insufficient awareness of practicing physicians about rare diseases [6, 7]. In this context, the issue of diagnosis and dental rehabilitation of paediatric patients with Clouston syndrome and congenital edentulism is no exception. Approved clinical guidelines for practicing physicians regarding this problem are absent.

The aim of this study is review of literatures regarding diagnosis and treatment procedure for paediatric and adolescent patients with Clouston syndrome and demonstration of possibilities in minimally invasive orthopaedic dental rehabilitation exemplified by a clinical case.

## Materials and Methods

Analysis of domestic and foreign scientific and educational literature devoted to the problem of differentiated approach to Clouston syndrome diagnosis and treatment procedures including rehabilitation. The search for the literature was performed in "Elibrary.ru" and "Web of Science" databases. During our investigation of the problem, the following trend was revealed: studies related to the syndrome are predominantly unsystematic and have the form of clinical case report with no relation to practical dentistry.

In order to demonstrate possibilities in effective dental rehabilitation in the aforementioned context, we present our clinical case of orthopaedic dental treatment provided to a 10-years-old patient with Clouston syndrome and congenital edentulism. In our case, the condition of the oral cavity was complex and ambiguous with dynamically changing clinical picture. We also provide long-term data of the patient follow up within the duration of 10 years.

## Results and Discussion

As the result of the analysis performed with the existing scientific literatures regarding to the studied topic, a theoretical basis of the problem and a system of main diagnostic features of Clouston syndrome have been formed. This system could be used by dentists of any profile as a diagnostic algorithm.

### *Historical note*

Clouston syndrome was described by H.R. Clouston in 1929 [8] and named after the author who revealed and described the disease. H.R. Clouston analysed 119 clinical cases of hidrotic ectodermal dysplasia in a group of French-Canadian descent in six generations. Thereafter, he formed the term "hidrotic form of ectodermal dysplasia" describing the essence of the pathology of this new nosological entity [9].

The varied clinical character of Clouston syndrome is determined by the level and character of ectodermal germ tissue differentiation. The patients with this hereditary genetic disease demonstrate severe abnormalities not only in dentoalveolar system formation, but in the whole organism in general. Symptoms of the hidrotic form of ectodermal dysplasia is closely associated with morphological and functional impairment of organs and tissues deriving from the ectodermal germ layer. A part of such impairments may progress asymptotically including the mineral metabolism level.

### *The algorithm of diagnosis of patients with Clouston syndrome*

1. Physical development. Intact, short stature, possible dwarfism (the symptom is not frequent) [1, 3, 5, 10].
2. Intellectual development. Intelligence is intact, possible slowness, intellectual deficit (the symptom is not frequent) [1, 3, 5, 10].
3. Genetic aspects of the problem. The classical modern concept is that Clouston syndrome as an autosomal dominant disease with variable expression (the severity may vary in one or different family). The disease develops from mutation in the GJB6 gene coding the ion channels protein connexin-30. The GJB6 gene also known as connexin-30 (gap junction protein beta 6) is located in the centromeric part of the long arm of the 13th chromosome in the 13q12.11 region. Mutations in this gene lead to development of autosomal dominant deafness type 3B, autosomal recessive deafness type 1B. Different mutations in the same gene have led to non-syndromic autosomal dominant deafness and development of the syndrome of keratitis-ichthyosis-deafness (KID) in at least one patient. Other connexin genes demonstrate similar variability of mutations: disease

combinations (e.g. connexin-31 gene (GJB3) mutations) may lead to either variable erythrokeratoderma or later onset of autosomal deafness [11-20]. According to other data, inheritance of the pathologic gene is conducted through any autosome. Clinical manifestations of the disease are pronounced both in homozygous and heterozygous state i.e. complete penetrance (always in all cases). [1, 3, 10]. Inheritance type – the autosomal inheritance type was described by H. Clouston (1929) [8, 9], the autosomal dominant inheritance was first revealed by R.B. Lowrey et al. (1966) in Canadian families of French descent [16, 21] and later by J.S. Giansani et al. (1974) [22]. Male and female patients suffer from the disease with equal frequency and severity (gender ratio of M1:F1). Occurrence rate in the population has not been revealed [6, 7].

4. Skin cover condition. Decrease in the number of perspiratory and sebaceous glands (the perspiratory and sebaceous glands). The number of perspiratory glands is decreased insignificantly, their morphological structure shows no significant changes. In a number of cases, there is progressing hyperkeratosis of palms and feet – overgrowth of the horny layer of skin (diffuse papillomatous hyperkeratosis of palms and feet, usually in the pressure points), hyperpigmentation of skin – excess pigmentation on skin over joints (especially in major joint areas), nipples, axillary cavities and pubis [1, 3, 5, 10, 23-30].

5. Head hair, facial hair and body hair condition. Head hair is hard and dull hair with increased fragility (hypotrichosis). Alopecia lesions are frequently visualised. Such symptoms progress over age leading to full (total) hair loss in both male and female patients. Analogical impairment is observed in overall facial and body hair. Histological examination of skin reveals insignificant epidermal atrophy, lack or underdevelopment of hair follicles. Electron microscopy of the hair shaft reveals disorganisation of hair fibrils and hair cortex layer thickness loss [1, 3, 5, 10, 23, 26-29, 31-33].

6. Nail condition. Nail pathology is characterised by dystrophy, hypoplasia and aplasia against the background of paronychia in the most severe cases. Infant and young children's nail plates have milk-white colour. With increasing age, they gradually thicken and become dystrophic. Adult patients' nail plates are thick, short, grow slowly and are distally separate from the nail bed. This creates painful sensation in a number of cases. There are clinical cases with protuberant nails. The severity of nail impairment in the patient may vary. There are cases of anonychia [1, 3, 5, 10, 12, 24, 26-29].

7. Ophthalmological symptoms. Strabismus (crossed eyes), cataract (the symptoms are not frequent) [1, 3, 5, 10].

8. Otological symptoms. Neurosensory deafness (the symptom is not frequent) [1, 3, 5, 10].

9. Dental symptoms. A characteristic clinical feature is multiple dental caries, hypodontia – congenital absence of

less than 6 teeth. Usually, second maxillary incisors and all mandibular incisors are absent. There is mosaic absence of premolars and less often there are clinical cases with absence of the whole group of molars. Teeth form anomaly is characteristic to the diagnosis (conoid teeth, Hutchinson's, Fournier's, Turner's teeth). Microdontia is intrinsic as well [1-3, 5, 10, 12, 23, 34, 35].

Quite an original and high-quality research on the problem of Clouston syndrome was performed by M.A. Kolesov in 2006. We consider the scientific data obtained of great importance in the context of this paper from the standpoint of clinical practice. Thus, we will take the liberty to present the results of the mentioned work below, according to the original source [34].

#### ***Inheritance types in patients with the hidrotic form of ectodermal dysplasia***

According to the results of medical genetic counseling for patients with the hidrotic form of ectodermal dysplasia, the autosomal dominant inheritance type was revealed in 69.7% cases and the X-linked recessive type in 3.03%. In the same number of cases, development of this disease was due to de novo mutations as no signs of the anomaly were found in the patient's relatives. In 6.06% cases, the inheritance type was not determined clearly according to available data on dental and general state of health of the proband and their relatives. Presumably, due to absence of complete information regarding relatives, among these 3.03% were with the X-linked recessive of autosomal dominant inheritance and 3.03% were associated with de novo mutations. The inheritance type was undetermined in 18.18% of the cases, although clinical examination revealed minor symptoms of the hidrotic form of ectodermal dysplasia. Therefore, the autosomal dominant inheritance type is predominant in patients with the hidrotic form of ectodermal dysplasia.

#### ***Results of phenotypic manifestations analysis for patients with the hidrotic form of ectodermal dysplasia***

Analysis of phenotypic manifestations in patients with the hidrotic form of ectodermal dysplasia was performed taking into account the phenotypic characteristics of hair, eyebrows, nails and skin.

Among the examined patients in this group, the condition of the "hair" characteristic was normal in 17.85% of the cases. In the rest of the patients, the characteristics of this parameter were: "fair" (64.3%), "fragile" (39.27%), "thin" (32.13%), "sparse" (17.85%), "dry" (17.85%) and "soft" (10.71%). These patients only had single characteristic manifestations in 21.75% of the cases. These were: "fair" (8.7%), "fragile" (8.7%) and "soft" (4.35%). At the same time, combination of two characteristics was established in



39.1% of the cases: “fair-fragile” (17.4%), “fair-thin” (8.7%), “fair-sparse” (4.35%), “fair-soft” (4.35%), “fragile-sparse” (4.35%). In 34.8% of the cases, the phenotypic parameter “hair” had three characteristics: “fair-fragile-dry” (8.7%), “fair-fragile-thin” (8.7%), “fair-fragile-soft” (4.35%), “fair-thin-dry” (4.35%), “fragile-thin-sparse” (4.35%) and “fair-sparse-dry” (4.35%). In the rest of the cases (4.35%), a combination of four characteristics (“fair-thin-sparse-dry”) was observed. Therefore, the most prevalent and pronounced characteristic of the “hair” phenotypic parameter in patients with the hidrotic form of ectodermal dysplasia was noted to be “fair” (64.3%). Of lower frequency but equal importance were the “fragile” (39.27%) and “thin” (32.13%) characteristics. At that, the characteristics were obligatorily combined and only 17.85% of the cases were considered normal.

The “eyebrows” phenotypic parameter in patients with the hidrotic form of ectodermal dysplasia had such characteristics as “fair”, “thin” and “sparse” with the following distribution: 17.85% of the cases featured “fair” eyebrows, 10.71% showed “thin” eyebrows and “sparse” eyebrows were observed in 3.57% of the cases. It was established that only 17.86% of the cases featured the aforementioned characteristics. Accordingly, the rest of the examined patients did not have such manifestations in the “eyebrows” phenotypic parameter. Manifestation of the characteristics was as follows. In 20% of the cases, only the “fair” characteristic was present; a combination of two characteristics was present in 60% of the cases – “fair-thin” (40%) and “fair-sparse” (20%); in 20% of the cases, a combination of all mentioned characteristics (“fair-thin-sparse”) was revealed.

Therefore, patients with the hidrotic form of ectodermal dysplasia showed normal condition of the “eyebrows” phenotypic parameter in 82.14% of the cases. Presence of abnormalities was manifested by “fair”, “thin”, and “sparse” characteristics with the leading “fair” characteristic (17.85%). The “nails” phenotypic parameter in patients with the hidrotic form of ectodermal dysplasia had such characteristics as “fragile” (33.3%), “thin” (22.2%), “chipping” (11.1%), “hyperplasia” (7.4%) and “aplasia” (3.7%). However, such characteristics were only present in 58.15% of the examined patients. The characteristics were distributed as follows: in 46.15% of the cases, the parameter only featured one characteristic: 15.38% for “fragile”, 15.38% for “hyperplasia”, 7.69% for “chipping” and 7.69% for “thin”. A combination of two characteristics was present in 46.15% of the patients with nail impairment: “fragile-thin” (30.77%), “chipping-fragile” (7.69%) and “fragile-aplasia” (7.69%). The rest of the patients showed the triad “chipping-fragile-thin” combination of characteristics in this parameter.

Thus, the main deviation of the “nails” phenotypic parameter in patients with the hidrotic form of ectodermal dysplasia was manifested by increased fragility (33.3% of the cases) and

this symptom could be combined with “chipping” or “thin” characteristics or their combination.

While determining characteristics of the “skin” phenotypic parameter in patients with the hidrotic form of ectodermal dysplasia, the following criteria were considered abnormalities: “fair”, “thin”, “dry”, “hyperkeratosis of feet and palms” as well as “hyperpigmentation” and “exudative diathesis”. It was noted that no eczemas were present on the patients’ skin. Normal condition of the skin was observed in 7.14% of the cases. The “skin” phenotypic parameter was determined to feature such characteristic as “dry” in 57.12% of the cases and local lesions of “hyperkeratosis of feet and palms” was revealed in 46.41% of the patients. “Exudative diathesis” phenomena were observed in 35.7% of the cases and 28.56% of the patients had “dry” skin, while “fair” skin was present in 17.85% of the cases. Change of the complexion in areas of hyperpigmentation and depigmentation (including the periorbital region) was registered in 14.28% of the cases. Additionally, variants in manifestation of this phenotypic parameter were determined as well as variants in combinations of such characteristics. Thus, singular characteristics revealed in the patients were: “dry” (14.28%), “hyperpigmentation” (7.14%) and “exudative diathesis” (7.14%). Combinations of two characteristics of the “skin” parameter were “hyperkeratosis-dry” (7.14%) and “hyperkeratosis-exudative diathesis” (7.14%), “fair-dry” (3.57%), “fair-thin” (3.57%) and “fair-hyperpigmentation” (3.57%). In all cases of a triad combination, the obligatory characteristics of “hyperkeratosis” and “dry” combined with “thin” (7.14%), “fair” (3.57%) or “hyperpigmentation” (3.57%). Appearance of four characteristics in the “skin” parameter was varied as well with obligatory presence of such characteristics as “hyperkeratosis” and “thin” in different combinations with “fair”, “dry” and “exudative diathesis” (3.57% each).

Therefore, the “skin” phenotypic parameter in patients with the hidrotic form of ectodermal dysplasia was only normal in 7.14% of the cases while main deviations were manifested by “dry” skin (57.12%) with less frequent “hyperkeratosis” of feet and palms (46.41%) and “exudative diathesis” (35.7%).

#### ***Clinico-radiological analysis of patients with the hidrotic form of ectodermal dysplasia***

Distribution of the number of missing teeth was 52.64% in the maxilla and 47.36% in the mandible. Thus, patients with the hidrotic form of ectodermal dysplasia lack teeth primordia in their maxilla 5.28% more frequently than in the mandible. The minimum amount of missing teeth attested to one missing tooth primordium and was observed in 12.12% of the cases. Therewith, the minimum absence of tooth was revealed in both the maxilla (12.12%) and the mandible (6.06%). However, in the latter case, it was against

the background of one or two absent teeth in the upper jaw. The maximum number of missing teeth was 26 and was present in 3.03% of the cases. At that, the maximum amount of missing maxillary teeth was 12 (6.06%) and 14 mandibular teeth (3.03%).

Maxillary teeth of patients with the hidrotic form of ectodermal dysplasia are thus more subject to edentulism and the quantity of absent teeth may vary from 1 to 26 which attests to the edentulism degree of 3.13% to 81.25%. On average, edentulism in this group of patients totalled 25.3% and the most common number of missing teeth was two (18.75% of the cases). Distribution of edentulism prevalence in patients with the hidrotic form of ectodermal dysplasia is presented in Table 1.

As it follows from the data presented in Table 1, the patients with the hidrotic form of ectodermal dysplasia show absence of central incisors in 6.88% of the cases while mandibular incisors are significantly more likely to be absent (6.07% of the cases vs. 0.81% for the maxilla). In contrast, absence of maxillary lateral incisors was established to be more frequent in comparison with the mandibular ones (18.22% and 6.88%, respectively), which in total amounted to 25.1% of the missing teeth. The canines were only subject to edentulism in 4.05% of the cases (1.62% for maxillary canines and 2.43% for mandibular canines). Absence of first premolars was registered in the same amount of cases as that of central incisors (6.88%) and was prevalent in the maxilla (4.86%) in comparison with the mandible (2.02%). Second premolars and their primordia were absent in 20.24% of the cases equally in the maxilla and the mandible (10.12% each). First molars were only missing in 1.62% of the cases and only in the mandible, while absence of maxillary first molars was not found in patients with the hidrotic form of ectodermal dysplasia within the framework of our study. Absence of second molars was registered in 7.28% of the cases (3.24% and 4.04% for the maxillary and the mandibular, respectively). Third molars were missing in 27.95% of the cases: 13.77% in the maxilla and 14.18% in the mandible. As a result of clinical and radiological examination of patients with the hidrotic form of ectodermal dysplasia, it was revealed that teeth development abnormalities may be manifested, apart from edentulism, by microdontia with deformation of teeth (conoid shape). Therefore, 3.03% of

the clinically and radiologically examined patients showed microdontia of two lateral incisors of the maxilla and presence of the full set of permanent teeth. Edentulism was combined with microdontia of one maxillary lateral incisor in 18.18% of the cases. At that, microdontia of the left maxillary lateral incisor was found in 12.12% of the cases while it was 6.06% for microdontia of the right maxillary lateral incisor. In 3.03% of the cases, microdontia of this tooth was combined with presence of a supernumerary tooth in this area which was confirmed radiologically.

Hence, it may be concluded that maxillary teeth of patients with the hidrotic form of ectodermal dysplasia are more subject to edentulism and the quantity of missing teeth may vary from 1 to 26, which is 3.13% to 81.25% of their normal quantity. On the average, edentulism totalled 25.3% in this group of patients and absence of two teeth was most common. It was also established that primordia of lateral incisors in the maxilla were most commonly missing teeth (18.22%) and absence of maxillary central incisors was least common (0.81%), while first maxillary molars were not subject to edentulism completely. Among dental impairments in patients with this form of ectodermal dysplasia, there may be abnormalities of shape (conoid teeth) and size (microdontia) along with the decline in the number of teeth (edentulism).

**Results of microelement content analysis for patients with the hidrotic form of ectodermal dysplasia**

Deviations in both essential and toxic microelement content in patients with the hidrotic form of ectodermal dysplasia were revealed.

Among the elements related to conventionally essential, deviations from the norm were only registered for cadmium (Cd) and nickel (Ni) content increase (6.67% each). Other conventionally essential microelements were within the limits of normal including aluminium and mercury (Hg).

Among the essential elements, there was absence of normal values in all patients with this form of ectodermal dysplasia. Thus, the content of cobalt (Co), ferrum (Fe), potassium (K), manganese (Mn) and sodium (Na) was within the limits of normal in 13.34-40.02% of the cases and there was always the trend toward gradual decrease in their concentration in the organism. Thus, their content was within the lower limit of

**Table 1.** Prevalence and distribution of edentulism in patients with the hidrotic form of ectodermal dysplasia (% of the overall number of missing teeth) [34]

	Central incisors	Lateral incisors	Canines	First premolars	Second premolars	First molars	Second molars	Third molars	Total:
<b>Maxillary</b>	0.81	18.22	1.62	4.86	10.12	0	3.24	13.77	52.64
<b>Mandibular</b>	6.07	6.88	2.43	2.02	10.12	1.62	4.04	14.18	47.36
<b>Total:</b>	6.88	25.1	4.05	6.88	20.24	1.62	7.28	27.95	100

normal in 6.67-26.68% of the cases and their concentration was decreased in comparison to the norm in 53.36-73.37% of the cases (degrees 1-4). Calcium (Ca) and selenium (Se) content was registered to be within the limits of normal in 60.03% and 66.7% of the cases, respectively. The rest of the cases demonstrated decreased content of such substances within deviation degrees 1-4. Such microelements as iodine (I), chrome (Cr), copper (Cu) and magnesium (Mg) maintained the trend of the aforementioned elements: normal in 60.03-66.7% of the cases, within the lower limit of normal in 6.67% of the cases and decreased content (degrees 1-4) in 13.34-26.68% of the cases. However, the peculiarity of these elements was their increased content in 6.67-13.34% of the cases (degrees 1-4). The amount of cases characterising the content of phosphorus (P) and silicon (Si) was almost equally distributed among the limits of the normal and increased or decreased content. Concentration of zinc (Zn) was within the lower and upper limits of the normal in 73.37% and had increased concentration in 26.63% of the cases (degrees 1-2).

Hence, it is possible to conclude that deviations in microelement content in patients with the hidrotic form of ectodermal dysplasia are of chaotic character. However, the following tendency may be recognised. Silicon, phosphorus, magnesium, copper, chrome and iodine in the examined patients may either be within the limits of normal or have increased or decreased content (degrees 1-4). At the same time, zinc content may only be normal or increased by degrees 1-2 (premorbidly). Selenium, sodium, manganese, potassium, ferrum cobalt and calcium have the tendency to decrease in concentration only (degrees 1-4). Among conventionally essential microelements, deviations were only found in cadmium and nickel with 6.67% of the cases of increased content in the organism for both.

A numerically insignificant amount of articles has been devoted to the problem of orthopaedic dental rehabilitation of patients with Clouston syndrome and congenital edentulism [36, 37], undue radicalism in some of which [38-42] calls the efficacy of the described methods in short-term and long-term periods after treatment into question. In this regard, we present our clinical observation of an effective minimally invasive orthopaedic dental rehabilitation of a 10-years-old patient with the hidrotic form of ectodermal dysplasia and congenital edentulism with application of removable dentures made with shape memory materials – the “titanide” dental casting alloy as the material for the basis of the denture construction [43-47].

#### **Initial complaints**

Aesthetic complaints: smile aesthetics impairment due to occlusion abnormality, significant gaps between maxillary front teeth, absence of maxillary lateral incisors and all

mandibular incisors, deformation of maxillary central incisors and abnormal form of mandibular canines, dry facial skin, head hair defect. Morphological complaints: occlusion abnormality, absence of a large number of permanent maxillary and mandibular teeth, lack of physiological replacement of temporary teeth by permanent ones, over-retained primary teeth, defects in upper and lower dental arches. Functional complaints: complicated biting and chewing of food due to absence of teeth in upper and lower jaws and defects in front areas of upper and lower dental arches.

#### **Objective data**

Height – 145cm, weight – 38kg. Subcutaneous fat on the body and extremities was low. Hair on the hairy part of the head were fragile, thin and dry. Eyebrows and eyelashes were fair, thin and sparse. Internal organs showed no pathology. Examination of palms and feet showed insignificant hyperkeratosis and defects of nail plates (dystrophy, hypoplasia). Onychodystrophy and slow growth of nail plates were present. Perspiratory glands were intact. Skin cover in the regions of elbow and knee joints was insignificantly pigmented.

#### **Objective symptoms upon visual examination of the maxillofacial area**

Mesocephalic face type. Impairment of vertical and transverse facial proportions was not revealed. No deviations in facial symmetry. The height of the lower part of the face was not changed, the lower lip fell back, the mental fold was marked. The lower lip was full and turned to the outside (see Figure 2 – a, b). The facial skin was thin and dry. The external ears were large and protruding. Mouth opening value was and uncomplicated. Smiling showed narrow dental arches and wide buccal corridors. No pathological changes were found through palpation in right and left temporomandibular joints. Palpation of maxillofacial muscles was painless.

#### **Objective symptoms of the mouth vestibule and the oral cavity**

Pathological changes of the oral mucosa were absent. Labial and lingual frenula, buccal folds were clearly pronounced, adjusted closely to the upper part of the maxillary alveolar process and to the alveolar part of the mandible. The oral vestibule was shallow, the tongue was oval, with physiologically normal size with no apparent pathology. Excretory ducts of salivary glands were visible and demonstrated no apparent pathology. Palpation of parotid, submandibular and sublingual salivary glands showed a physiologically normal amount of secretion.

Examination of teeth and dental arches revealed abnormal conoid (spear-like, narrow-edged) form of 4.3 and 3.3

supernumerary teeth with sharp ends of the cutting edges non-characteristic to permanent mandibular canines, abnormal barrel-like shape with no semilunar incision of the cutting edge (Fournier's teeth) in teeth 1.1 and 2.1. Class 3 diastema was present between teeth 1.1 and 2.1. The upper lip frenulum was in the form of a wide band entangled into the upper part of the alveolar process between teeth 1.1 and

2.1. Persistent (remaining temporary) teeth 5.5, 6.5, 7.5, 7.4, 8.4, 8.5 and abnormal supernumerary teeth 4.3 и 3.3 had no facing of natural dental abrasion compliant with the patient's age. Reaction of all temporary and permanent teeth in the oral cavity to probing, percussion, temperature stimuli was painless. Inter-alveolar height was not decreased. The occlusion was pathologic and fixed (see Table 2).



Figure 1. Patient P., 8 years old, orthopantomogram

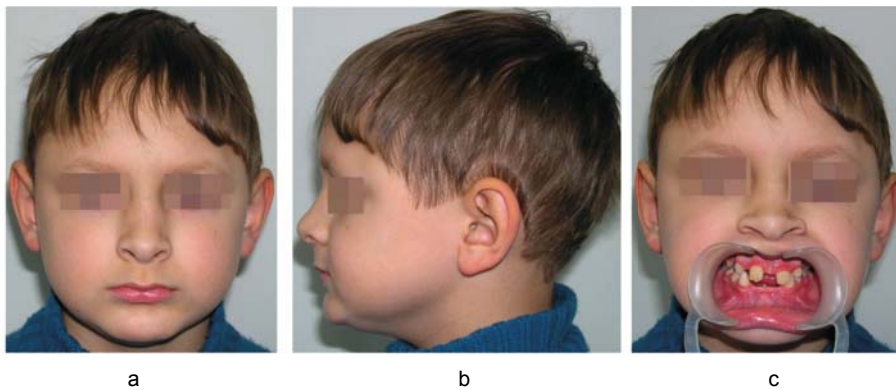


Figure 2. Patient P., 10, external view: a – frontal projection, b – left lateral projection, c – condition of the oral cavity

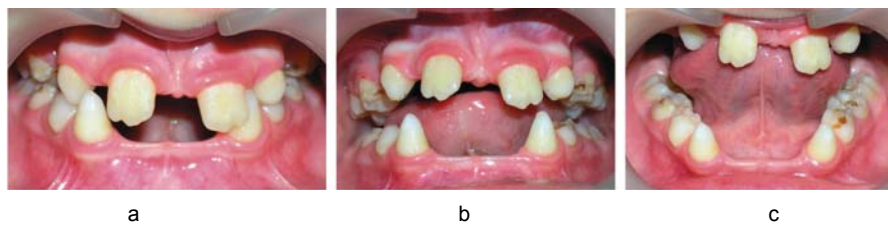


Figure 3. Patient P., 10 years old, condition of the oral cavity: a – central occlusion position, b – maxillary dental arch condition, c – mandibular dental arch condition

Table 2. Dental formula of patient P., 10 years old

M	M	1.6	5.5	M	1.3	M	1.1	2.1	M	2.3	M	6.5	2.6	M	M
			(C)				(A)	(A)				(C)			
M	M	4.6	8.5	8.4	4.3	M	M	M	M	3.3	7.4	7.5	3.6	M	M
			(C)		(A)					(A)	(C)	(C)			

Legend: M – missing tooth, C – dental caries, A – abnormal crown form.

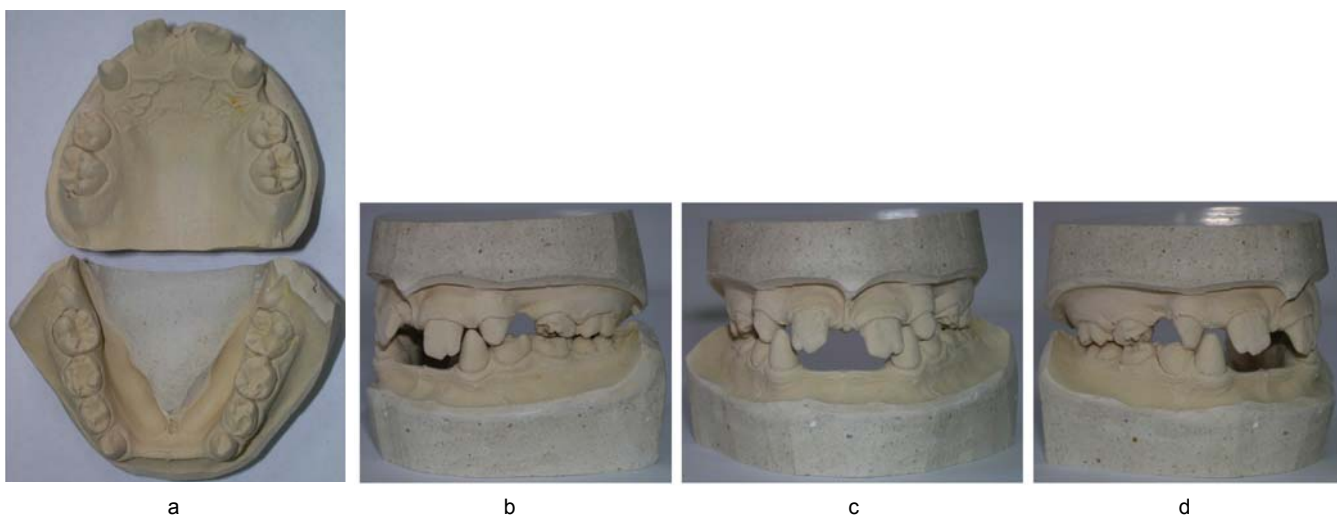


According to normal age-specific physiological development of the oral cavity, permanent teeth 1.4, 1.2, 2.2, 2.4, 3.4, 3.3, 3.2, 3.1, 4.1, 4.2, 4.3, 4.4 were absent. Defects of maxillary and mandibular dental arches were analogically in compliance with class IV of dental arch defects according to the Kennedy classification: bounded edentulous teeth in the front part. Toothless areas of the maxilla and the mandible demonstrated hypoplasia (underdevelopment) and pointed shape. The maxillary dental arch was of semielliptical shape and the mandibular dental arch was trapezium-shaped.

**Radiological symptoms**

The patient's parents provided the orthopantomogram images made at the patient's age of 8 years (see Figure 1) and 10 years (see Figure 4).

The orthopantomogram of the patient at the age of 8 visualised absent primordia of permanent teeth 1.4, 1.2, 2.2, 2.4, 3.5, 3.2, 3.1, 4.1, 4.2, 4.4, 4.5. Teeth 4.3 and 3.3 were supernumerary. Development of their root was at the stage of incomplete longitudinal formation of the root. Supernumerary teeth 4.3 and 3.3 had primordia of normal teeth in the root part projection. Primordia of teeth 1.7, 1.6, 1.1, 2.1, 2.6, 2.7,



**Figure 4.** Patient P., 10 years old, diagnostic casts: a – occlusal projection, b – left semi-lateral projection in the central occlusion position, c – frontal projection in the central occlusion position, d – right semi-lateral projection in the central occlusion position



**Figure 5.** Patient P., 10 years old, orthopantomogram

3.7, 3.6, 3.4, 3.3, 4.3, 4.6, 4.7 showed radiological symptoms of calcium deficiency in the coronal sections. Persistent (remaining temporary) teeth 7.5, 7.4, 7.3, 8.5 showed no root resorption. There were no pathological changes in bone tissue in the projection of the present roots of temporary and permanent teeth. The shape of left and right articular heads of the mandible are within the physiological norm according to the patient's age. In the projection of absent permanent teeth, there were radiological symptoms of hypoplasia (reduction in the vertical dimension) in the maxillary alveolar process and the alveolar part of the mandible (see Figure 1).

The orthopantomogram of the patient at the age of 10 visualised absence of permanent teeth 1.4, 1.2, 2.2, 2.4, 3.5, 3.2, 3.1, 4.1, 4.2, 4.4, 4.5. Teeth 4.3 and 3.3 were supernumerary. Development of their roots was at the stage of undeveloped root apex. Supernumerary teeth 4.3 and 3.3 had primordia of normal teeth in the root part projection with mineralised coronal sections. Primordia of teeth 1.7, 1.5, 2.5, 2.7, 3.7, 3.4, 4.7 demonstrated radiological symptoms of calcium deficiency of coronal sections of the teeth at different development stages. Temporary teeth 5.5, 6.5, 7.4 had radiological symptoms of physiological resorption of roots associated with development of the underlying primordia of the respective permanent teeth. Persistent (remaining temporary) teeth 7.5, 8.4, 8.5 had no root resorption. Pathological changes in bone tissue in the projection of present roots of temporary and permanent teeth were absent. The shape of left and right articular heads of the mandible are within the physiological norm according to the patient's age. In the projection of absent permanent teeth, there were radiological symptoms of hypoplasia (reduction in the vertical dimension) in the maxillary alveolar process and the alveolar part of the mandible (see Figure 4).

**From medical history:** according to the parents' words, the child was born after he first pregnancy and first delivery (abortion count was 0). The delivery was timely, the body mass on delivery was 3,500 g with height of 55cm. According to the mother's words, there were no complications of the

pregnancy. Systemic or infectious diseases were absent during the pregnancy. The father was clinically healthy and had undergone a course of radiotherapy due to an oncological disease 22 years ago and the mother had primary edentulism of the 12th tooth. The child cut the full set of his temporary teeth and had normal primary teeth occlusion. According to the parents' words Earlier and concomitant pathologies of the child were acute respiratory diseases. The diagnosis of ectodermal dysplasia in the hidrotic form (Clouston syndrome) was established for the first time (at the age of 10). There had been no reference to a geneticist physician. No orthodontic (prosthetic) treatment had been performed.

**Diagnosis:** ectodermal dysplasia (Q82.4), hidrotic form (Clouston syndrome), congenital maxillary hypodontia (congenital absence of less than 6 teeth) and mandibular oligodontia (congenital absence of more than 6 teeth) of permanent teeth (K00.0), hypoplasia of the upper part of the maxillary alveolar process and alveolar part of the mandible in the projection of congenital absence of teeth (K06.9). Abnormal (conoid) shape of supernumerary teeth 4.3 and 3.3 (K00.2, K00.1), abnormality of the shape (Fournier's teeth) in teeth 1.1 and 2.1 (K00.2), diastema (K07.3). Delay in replacement of primary (milk) teeth: persistent teeth 7.5, 8.4, 8.5 (K00.6). Defects in maxillary and mandibular dental arches matching class IV of dental arch defects according to the Kennedy classification. Pathological, fixed occlusion.

**Orthopaedic treatment:** the patient received orthodontic treatment of the diastema. Premanufactured individual impression trays were used to obtain imprints of maxillary and mandibular dental arches with application of silicone impression compound. Thereafter, removable maxillary and mandibular dentures with bases from titanium nickelide were produced. The patient's adaptation to removable dentures was achieved in 7 days. Thereafter, the patient noted satisfactory functional state of the dentoalveolar system. As the result of orthopaedic dental treatment, the aesthetics and psychological comfort

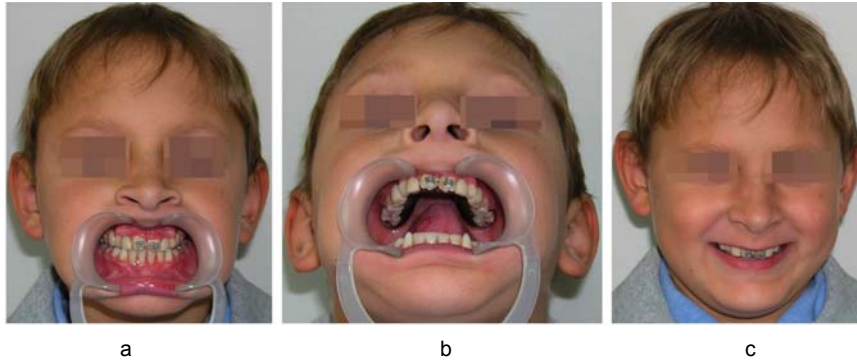


**Figure 6.** Patient P., 10 years old, removable dentures: a – maxillary, mandibular



of the patient were restored to the maximum possible extent (see figure 12). The parents noted the child's complete age-conforming social adaptation, good academic achievement,

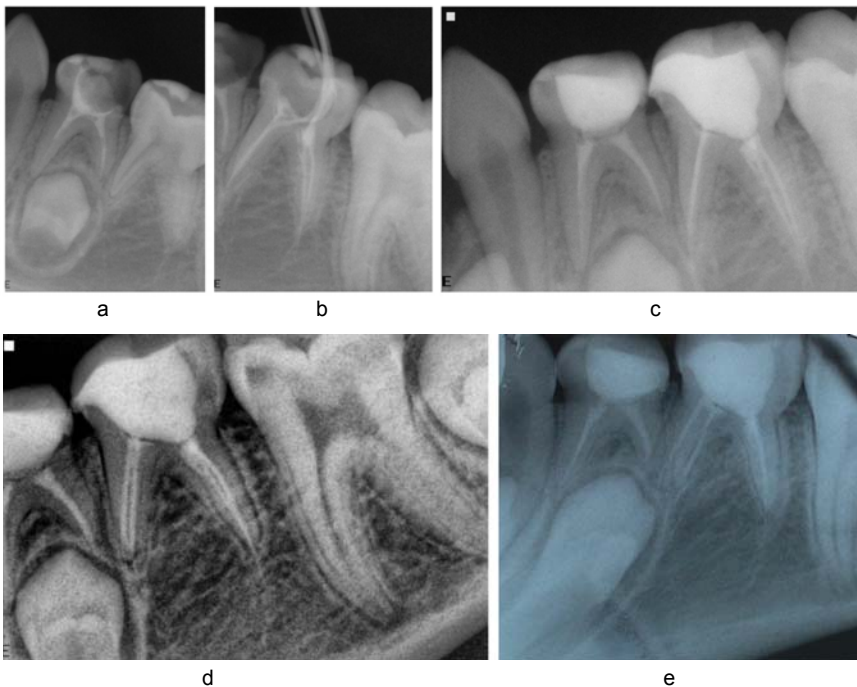
established communication with the peers, eliminated psychological and emotional lability associated with unusual appearances.



**Figure 7.** Patient P., 10 years old, after orthodontic and orthopaedic treatment: a – closed mouth, b – open mouth, c – frontal external view of the smile



**Figure 8.** Patient P., 10 years old, after orthodontic and orthopaedic treatment: a – closed mouth, b – open mouth



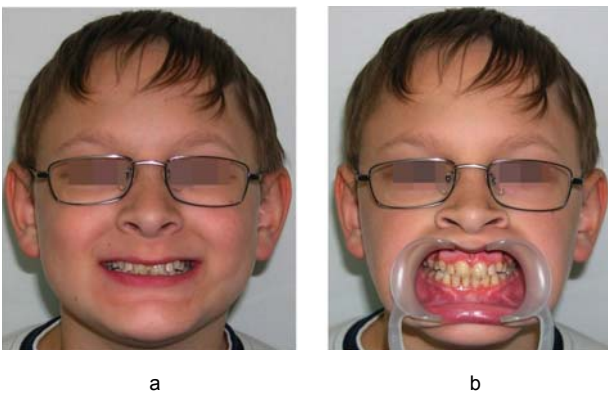
**Figure 9.** Patient P., 12 years old, radiograms of tooth 7.5: a – before treatment, b – control radiogram of root canal sealing quality after endodontic treatment, c – control radiogram after 6 month from endodontic treatment, d – control radiogram after 6 month from endodontic treatment, e – control radiogram after 6 month from endodontic treatment

**Recommendation:** 1) Consultation by a geneticist physician aimed at confirmation of the diagnosis of ectodermal dysplasia, hidrotic form (Clouston syndrome). 2) Consultation by a dermatologist and trichologist regarding the hair condition. 3) Dynamic observation by a dentist-orthopaedist (no less frequently than once per three months) for correction of removable dentures. 4) Periodically repeating production of new removable dentures with growing and developing jaws. 5) Consultation by the district orthopaedist and geneticist regarding the possibility and viability of registration of disability due to the main disease – ectodermal dysplasia, hidrotic form (Clouston).

Control examination at the age of 12, the patient had no complaints, the condition of prostheses and basal seat tissues was satisfactory (see Figures 9-11). Complicated caries with chronic fibrous pulpitis that emerged due to rapid progression of the carious process in teeth 5.5, 6.5, 7.5, 7.4, 8.5 observed in different periods of the follow-up between the ages of 10 and 12 years was treated through vital pulpectomy. At the final stage of endodontic treatment, the root canals were sealed using zinc-oxide-eugenol cement “Endometasone” (Septodont) with gutta-percha points [48].

According to the radiology data, apical level of root canal obturation was established at the distance of 0.5-2mm from the radiographic apex immediately after endodontic treatment. Control radiogram during dynamic observation showed hermeticity of root canal obturation through the whole length, homogeneity of root seals and absence of lumens between the seals and the canal walls. Symptoms of root resorption as well as pathological changes of bone tissue or periodontium in periapical regions were absent until the patient's age of 14. As an example, let us present the dynamics of the radiological picture of treatment of tooth 7.5 with the long-term follow-up period of 24 months (see Figure 9).

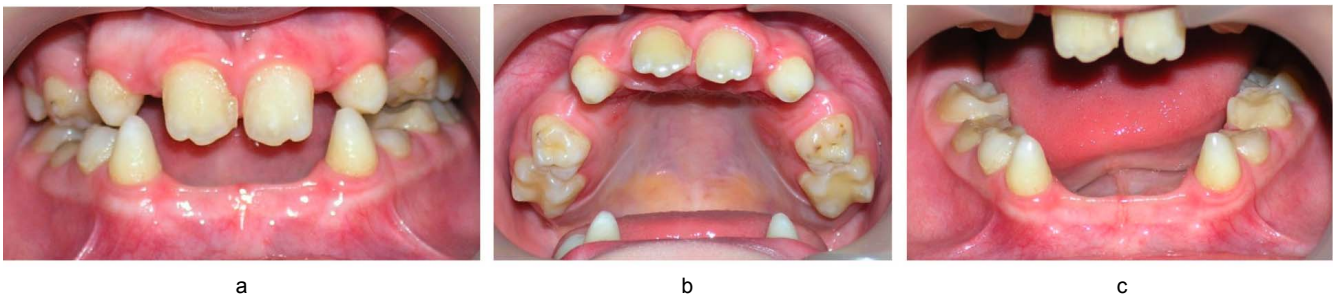
Control radiological examination of the dentoalveolar system at the age of 14 revealed a lesion of bone tissue destruction in the mandibular alveolar bone in the form of a radiolucency with clear oval outlines with horizontal longitudinal orientation from tooth 8.4 to tooth 7.5. Clinically, teeth 8.5, 8.4, 4.3, 3.3, 7.4, 7.5 have 3rd-degree mobility and symptoms of granulating periodontitis. Radiologically, roots of teeth 8.4, 4.3, 3.3, 7.4, 7.5 were in the lesion of alveolar bone tissue destruction, roots of abnormal supernumerary



**Figure 10.** Patient P., 12 years old, 2 years after the orthodontic and orthopaedic treatment: a – frontal external view of the smile, b – closed mouth



**Figure 11.** Patient P., 12 years old, the oral cavity condition after 2 years from the orthodontic and orthopaedic treatment



**Figure 12.** Patient P., 12 years old, the basal seat area tissues condition after 2 years from the orthodontic and orthopaedic treatment: a – central occlusion position, b – condition of the maxillary dental arch, c – condition of the mandibular dental arch

teeth 4.3 and 3.3 were resorbed at whole length. Tooth 8.5 was with radiological symptoms of granulating periodontitis. In the lesion of mandibular alveolar bone tissue destruction, there were primordia of normal teeth 4.3, 3.3, 3.4 at different stages of development (see Figure 13). Operative treatment was performed on the patient involving extraction of temporary teeth 8.5, 8.4, 7.4, 7.5, abnormal supernumerary permanent teeth 4.3 and 3.3, surgical debridement of the chronic inflammation lesion in the mandibular alveolar bone with retaining of primordia of normal teeth 4.3, 3.3, 3.4.

Thereafter, replacing therapy with a denture was performed on the mandible involving fenestration of the prosthetic basal seat area designed to stimulate and guide the cutting process for teeth 4.3, 3.3, 3.4 (see Figures 14-17). The adaptation period lasted for 7 days with subsequent notice of satisfactory functional condition of the dentoalveolar system by the patient. Over time with cutting of teeth 4.3, 3.3, 3.4 assisted by chewing pressure of the orthopaedic construction, correction and deepening of the window-form guides.



**Figure 13.** Patient P., 12 years old, orthopantomogram

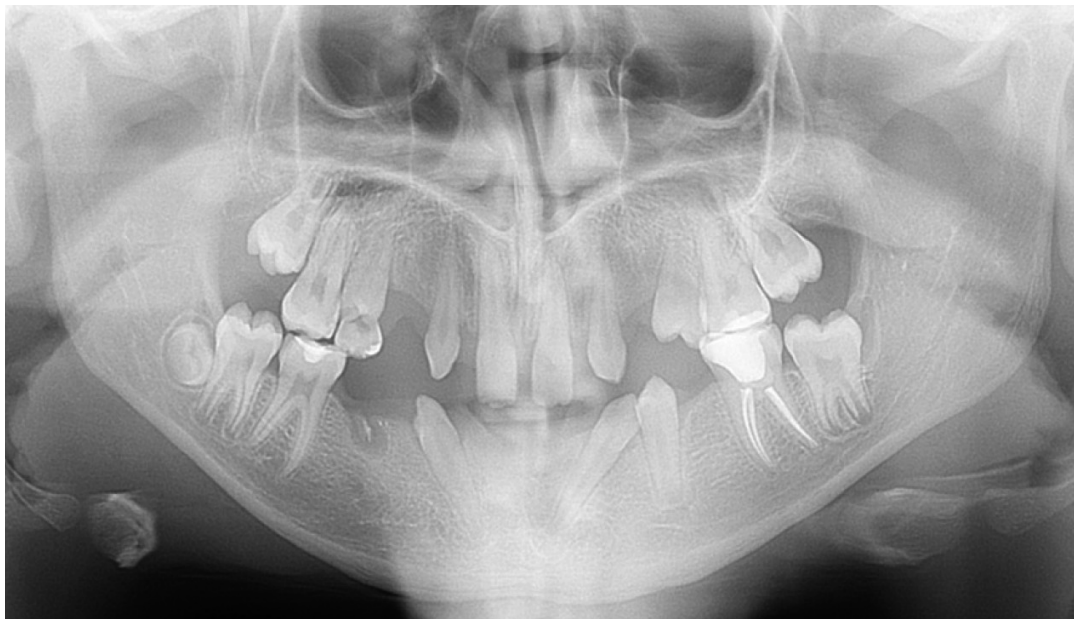


**Figure 14.** Patient P., 14 years old, orthopantomogram

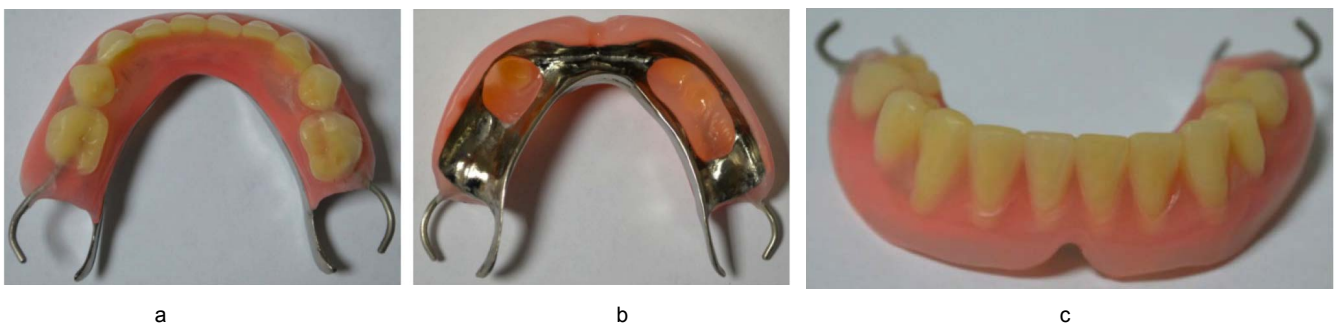




**Figure 15.** Patient P., 14 years old, the oral cavity condition after 4 years from the orthodontic and orthopaedic treatment, operative treatment of the mandibular alveolar bone: a – central occlusion position, b – condition of the mandibular dental arch



**Figure 16.** Patient P., 14 years old, orthopantomogram



**Figure 17.** Patient P., 14 years old, a replacing removable mandibular denture manufactured after operative treatment of the mandibular alveolar bone: a –occlusal projection, b – basal seat area projection, c – frontal projection

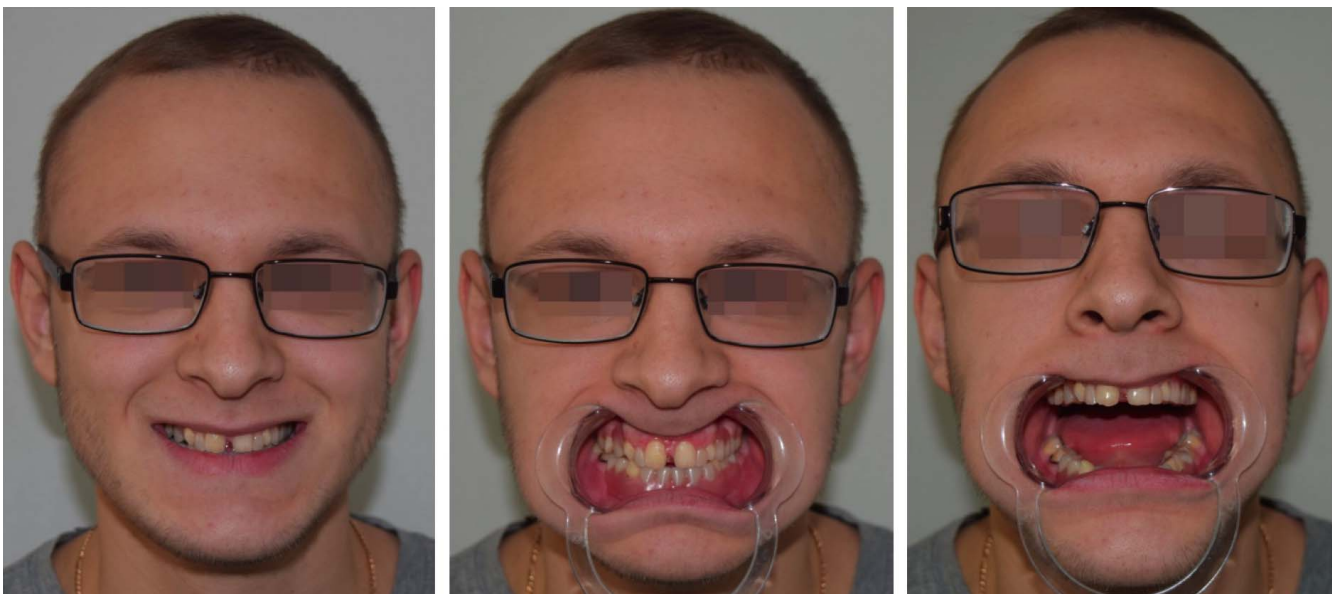


**Figure 18.** Patient P., 14 years old, frontal external view of the smile after operative treatment and treatment with removable mandibular denture

No complaints during a control examination were presented by the patient at the age of 20. The condition of dentures and basal seat area tissues were satisfactory. Over time, window-shaped guides of the mandibular denture were reshaped into perforations due to increase in height of clinical crowns of teeth 4.3, 3.3, 3.4 and their occlusal contact with the antagonists. A new removable laminar denture was produced for the maxilla due to its physiological growth. The condition of dentures, functional state of the dentoalveolar system and the condition of basal seat tissues were satisfactory (see Figures 18-22).

### Conclusion

The presented concise review of domestic and foreign literatures devoted to main diagnostic clinical features of Clouston syndrome is an effective diagnostic algorithm in clinical practice of orthopaedic dentistry and orthodontics. The algorithm forms a clear route of consultations with related professionals of the general profile in cases of registration of patients with this rare orphan pathology.

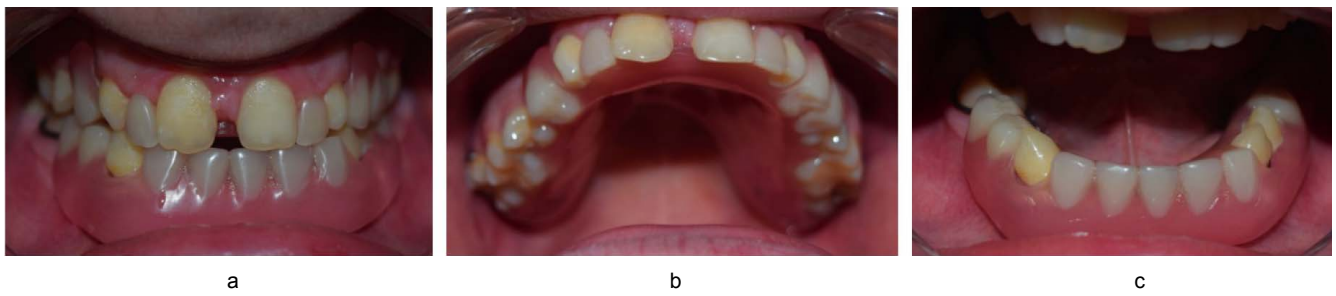


a

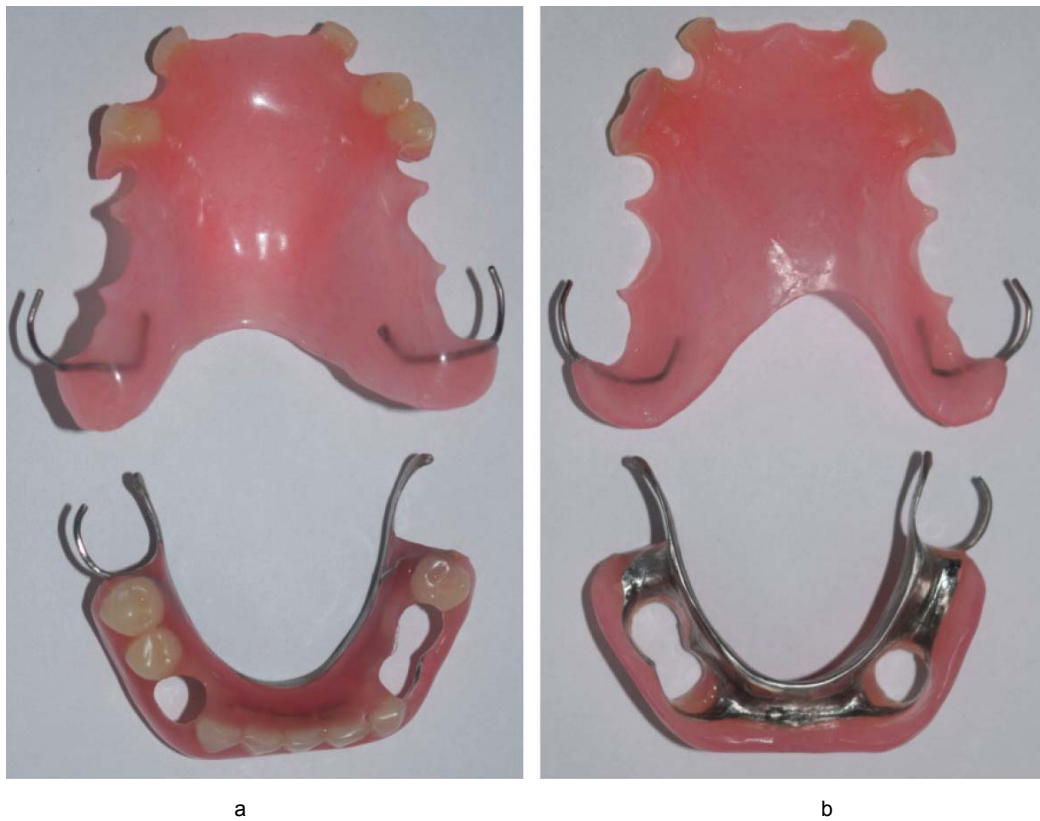
b

c

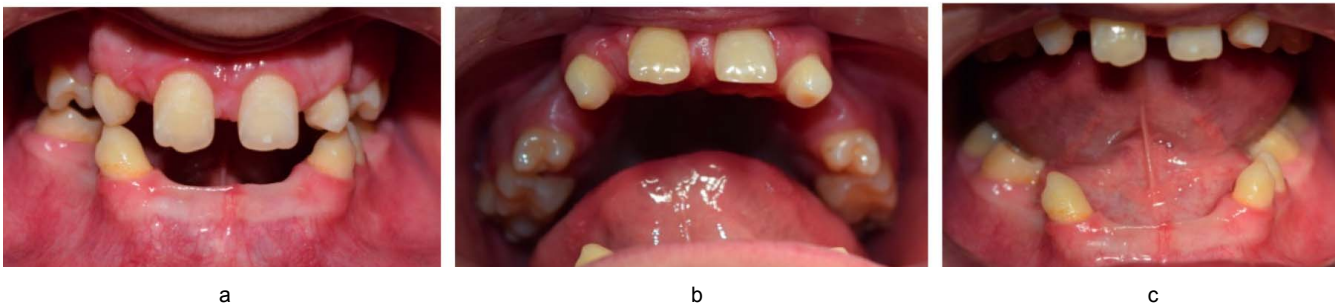
**Figure 19.** Patient P., 20 years old, after 10 years from the dental treatment: a – frontal external view of the smile, b – closed mouth, c – open mouth



**Figure 20.** Patient P., 20 years old, condition of the oral cavity after 10 years from the complex dental treatment: a – closed mouth, b – condition of the maxillary dental arch, c – condition of the mandibular dental arch



**Figure 21.** Patient P., 20 years old, maxillary and mandibular removable dentures: a – occlusive projection, b – basal seat area projectio



**Figure 22.** Patient P., 20 years old, condition of the basal seat area tissues after 10 years of removable orthopaedic dental constructions: a – closed mouth, b – condition of the maxillary dental arch, c – condition of the mandibular dental arch





Figure 23. Patient P., 20 years old, orthopantomogram



Figure 24. Patient P., diagnostic casts at the ages of 10, 12, 14 and 20, dynamics of maxillary and mandibular dental arches growth

The presented clinical case of minimally invasive orthopaedic dental methods for rehabilitation of patients with Clouston syndrome and congenital edentulism is an option providing predictable and satisfactory aesthetic and functional treatment outcomes, social adaptation of patients and a wide spectrum of later clinical decisions in short-term and long-term management of the patients after the treatment. Application of shape memory materials in compliance with the developed technologies of prosthetic dentistry has made

it possible to drastically increase efficacy of orthopaedic treatment for paediatric and adolescent patients with Clouston syndrome and congenital edentulism. Peculiarities of prosthetic base production eliminating contact of synthetic resin with basal seat area tissues and minimal shrinkage of the "titanide" dental alloy provide for precise matching of the prosthesis and the basal seat area. Absence of macro shears of the construction on the surface of basal seat area tissues provides for even distribution of the mastication load on

unpliable, medium-hard and pliable tissues of the basal seat area enlarging the effective area of the support structures. At that, superelastic properties of titanium nickelide promote damping of the load and harmonious functioning of the denture in the organism replacing the absent anatomical structures.

Elastic behaviour of the clasp system provides for easy positioning, fixation and removing of the prosthesis including the situation of dental malposition, prevents traumatic overload and tension in the periodontium of the supporting teeth and, as a result, their pathological mobility. Therewith, increased resistance of the material to fatigue against the background of long-term multidirectional deformations increases robustness, durability of the denture while retaining the acquired stability. All the aforesaid in combination with biocompatibility of titanium nickelide with organic tissues

prevents inflammation and progression of basal seat area tissue atrophy and also stimulates age-related development of the jaws.

### Conflict of Interest Statement

The authors declare absence of conflict of interest. The study received no sponsorship. The researchers carry full responsibility for submission of the final version of the manuscript for publication. All authors participated in development of the concept and design of the study and in preparation of the manuscript. The final version was approved by all authors. No financial reward was received for the study.

### References

- Kenneth LJ. Smith's Recognizable Patterns of Human Malformation. Moscow: Practice; 2011. p. 1–1024. Russian.
- Kolesov MA, Pankratova NV. The ectodermal dysplasia and its manifestation in oral cavity. *Orthodontics*. 2004;(1):21–5. Russian.
- Kozlova SI, Demikova NS, Semanova E, Blinnikova OE. Hereditary syndromes and medical-genetic consulting. Moscow: Practice; 1996. p. 1–416. Russian.
- Galonsky VG, Radkevich AA, Chernov VN, Tarasova NV, Gradoboev AV. Late morphological and functional results of orthopaedic rehabilitation for patients with damaged ectodermal dysplasia and complete congenital edentulism. Ushnitsky ID, editor. Relevant problems and prospects in dentistry development in the North. A collection of articles of the interregional scientific-practical conference devoted to the 100 years anniversary in the Republic of Sakha (Yakutia). Yakutsk: Publishing house SVFU; 2020. p. 309–51. Russian.
- Galonsky VG, Radkevich AA, Shushakova AA, Tumshevits VO. Ectodermal dysplasia: typical clinical signs and methods of dental rehabilitation. *The Siberian Medical Journal*. 2011;26(2-1):21–7. Russian.
- Novikov PV. Rare (orphan) diseases and congenital diseases in children: problems and goals at the present stage. *Clinical practice in pediatrics*. 2011;6(1):34–44. Russian.
- Novikov PV. Legal issues relating to rare (orphan) diseases - Russian and international experience. *Medicine*. 2013;1(4):53–73. Russian.
- Clouston HR. A hereditary ectodermal dystrophy. *Can Med Assoc J*. 1929;21(1):18–31.
- Clouston HR. The major forms of hereditary ectodermal dysplasia : (With an Autopsy and Biopsies on the Anhydrotic Type). *Can Med Assoc J*. 1939;40(1):1–7.
- Badalyan LO, editor. Hereditary diseases: a reference book. Tashkent: Medicine; 1980. p. 1–415. Russian.
- Fraser FC, Der Kaloustian VM. A man, a syndrome, a gene: Clouston's hidrotic ectodermal dysplasia (HED). *Am J Med Genet*. 2001;100(2):164–8. [https://doi.org/10.1002/1096-8628\(20010422\)100:2<164::AID-AJMG1244>3.0.CO;2-W](https://doi.org/10.1002/1096-8628(20010422)100:2<164::AID-AJMG1244>3.0.CO;2-W)
- Hudson CD, Witkop CJ. Autosomal dominant hypodontia with nail dysgenesis. Report of twenty-nine cases in six families. *Oral Surg Oral Med Oral Pathol*. 1975;39(3):409–23. [https://doi.org/10.1016/0030-4220\(75\)90085-7](https://doi.org/10.1016/0030-4220(75)90085-7)
- Agarwal N, Singh PK, Gupta K, Gupta N, Kabra M. Identification of GJB6 gene mutation in an Indian man with Clouston syndrome. *Indian J Dermatol Venereol Leprol*. 2016;82(6):697–700. <https://doi.org/10.4103/0378-6323.190855>
- Kibar Z, Lafrenière RG, Chakravarti A, Wang JC, Chevrette M, Der Kaloustian VM, et al. A radiation hybrid map of 48 loci including the clouston hidrotic ectodermal dysplasia locus in the pericentromeric region of chromosome 13q. *Genomics*. 1999;56(1):127–30. <https://doi.org/10.1006/geno.1998.5698>
- Kibar Z, Dubé MP, Powell J, McCuaig C, Hayflick SJ, Zonana J, et al. Clouston hidrotic ectodermal dysplasia (HED): genetic homogeneity, presence of a founder effect in the French Canadian population and fine genetic mapping. *Eur J Hum Genet*. 2000;8(5):372–80. <https://doi.org/10.1038/sj.ejhg.5200471>
- Lamartine J, Laoudj D, Blanchet-Bardon C, Kibar Z, Soularue P, Ridoux V, et al. Refined localization of the gene for Clouston

- syndrome (hidrotic ectodermal dysplasia) in a large French family. *Br J Dermatol*. 2000;142(2):248–52. <https://doi.org/10.1046/j.1365-2133.2000.03292.x>
17. Khatter S, Puri RD, Mahay SB, Bhai P, Saxena R, Verma IC. Mutation-Proved Clouston Syndrome in a Large Indian Family with a Variant Phenotype. *Indian J Dermatol*. 2019;64(2):143–5. [https://doi.org/10.4103/ijid.IJD\\_510\\_17](https://doi.org/10.4103/ijid.IJD_510_17)
  18. Liu YT, Guo K, Li J, Liu Y, Zeng WH, Geng SM. Novel mutations in GJB6 and GJB2 in Clouston syndrome. *Clin Exp Dermatol*. 2015;40(7):770–3. <https://doi.org/10.1111/ced.12654>
  19. Taylor TD, Hayflick SJ, McKinnon W, Guttmacher AE, Hovnanian A, Litt M, et al. Confirmation of linkage of Clouston syndrome (hidrotic ectodermal dysplasia) to 13q11-q12.1 with evidence for multiple independent mutations. *J Invest Dermatol*. 1998;111(1):83–5. <https://doi.org/10.1046/j.1523-1747.1998.00245.x>
  20. Radhakrishna U, Blouin JL, Mehenni H, Mehta TY, Sheth FJ, Sheth JJ, et al. The gene for autosomal dominant hidrotic ectodermal dysplasia (Clouston syndrome) in a large Indian family maps to the 13q11-q12.1 pericentromeric region. *Am J Med Genet*. 1997;71(1):80–6. [https://doi.org/10.1002/\(sici\)1096-8628\(19970711\)71:1<80::aid-ajmg15>3.0.co;2-r](https://doi.org/10.1002/(sici)1096-8628(19970711)71:1<80::aid-ajmg15>3.0.co;2-r)
  21. Smith RA, Vargervik K, Kearns G, Bosch C, Koumjian J. Placement of an endosseous implant in a growing child with ectodermal dysplasia. *Oral Surg Oral Med Oral Pathol*. 1993;75(6):669–73. [https://doi.org/10.1016/0030-4220\(93\)90419-5](https://doi.org/10.1016/0030-4220(93)90419-5)
  22. Giansanti JS, Long SM, Rankin JL. The “tooth and nail” type of autosomal dominant ectodermal dysplasia. *Oral Surg Oral Med Oral Pathol*. 1974;37(4):576–82. [https://doi.org/10.1016/0030-4220\(74\)90289-8](https://doi.org/10.1016/0030-4220(74)90289-8)
  23. Belyakov YuA. Hereditary diseases and syndromes in dental practice. Moscow: Medicine; 2008. p. 1–240. Russian.
  24. Kirdakiv DF, Potekaev NN. Keratodermias. *Russian Journal of Clinical Dermatology and Venereology*. 2009;7(6):7–13. Russian.
  25. Kellermayer R, Keller M, Ratajczak P, Richardson E, Harangi F, Mérei E, et al. Bigenic connexin mutations in a patient with hidrotic ectodermal dysplasia. *Eur J Dermatol*. 2005;15(2):75–9.
  26. Cammarata-Scalisi F, Rinelli M, Pisaneschi E, Diociaiuti A, Willoughby CE, Avendaño A, et al. Novel clinical features associated with Clouston syndrome. *Int J Dermatol*. 2019;58(8):e143–6. <https://doi.org/10.1111/ijd.14507>
  27. Trídico LA, Antonio JR, Pozetti EM, Rosa AM, Antonio CR. Clouston Syndrome: 25-year follow-up of a patient. *An Bras Dermatol*. 2015;90(6):897–9. <https://doi.org/10.1590/abd1806-4841.20153990>
  28. Marakhonov A, Skoblov M, Galkina V, Zinchenko R. Clouston syndrome: first case in Russia. *Balkan J Med Genet*. 2012;15(1):51–4. <https://doi.org/10.2478/v10034-012-0008-9>
  29. Sanches S, Rebellato PRO, Fabre AB, Campos GLM. Do you know this syndrome? Clouston syndrome. *An Bras Dermatol*. 2017;92(3):417–8. <http://dx.doi.org/10.1590/abd1806-4841.20175716>
  30. Tan E, Tay YK. What syndrome is this? Hidrotic ectodermal dysplasia (Clouston syndrome). *Pediatr Dermatol*. 2000;17(1):65–7. <https://doi.org/10.1046/j.1525-1470.2000.01713.x>
  31. Damarad A, Dubovik A. Genetic and congenital syndromes associated with hair loss in children: causes, clinical features. *Dermatovenerology. Cosmetology*. 2016;2(1):43–59. Russian.
  32. Korotkiy NG, Sharova NM, Kostina SV. Alopecia areata in monozygotic twins as one of the manifestations of clouston syndrome. *Clinical practice in pediatrics*. 2009;4(4):88–90. Russian.
  33. Soloshenko EN. Clinical varieties of alopecia: pathogenesis, differential diagnosis, therapy. *International Medical Journal*. 2009;15(1):102–9. Russian.
  34. Bergendal B. Orofacial manifestations in ectodermal dysplasia - a review. *Am J Med Genet A*. 2014;164A(10):2465–71. <https://doi.org/10.1002/ajmg.a.36571>
  35. Petrov RS, Kurilo LF, Demikova NS, Kozlova SI. Hereditary syndromes involving disorders of the embryonic development of the oral cavity. *Clinical and experimental morphology*. 2014;(4):4–13. Russian.
  36. Singh T, Singh R, Singh GP, Singh JP. Hypohidrotic ectodermal dysplasia: a felicitous approach to esthetic and prosthetic management. *Int J Clin Pediatr Dent*. 2013;6(2):140–5. <https://doi.org/10.5005/jp-journals-10005-1207>
  37. Gupta C, Verma M, Gupta R, Gill S. Telescopic overdenture for oral rehabilitation of ectodermal dysplasia patient. *Contemp Clin Dent*. 2015;6(Suppl 1):S258–61. <https://doi.org/10.4103/0976-237X.166821>
  38. Ghoveizi R, Siadat H, Nikzad S, Ommati Shabestari G, Soleimani Shayesteh Y. Full mouth rehabilitation of an ectodermal dysplasia patient with implant-supported prostheses: a clinical report. *J Dent (Tehran)*. 2013;10(3):283–8.
  39. Mascolo A, Boschetti E, Flanagan D. An ectodermal dysplasia patient treated with a small diameter implant supporting a single crown. *Clin Cosmet Investig Dent*. 2018;10:171–7. <https://doi.org/10.2147/CCIDE.S170670>
  40. Priya V, Srivatsa, Ramachandraprabakar, Kannan K, Dwaragesh. Multidisciplinary approach of ectodermal dysplasia with implant retained fixed prosthesis. *J Pharm Bioallied Sci*. 2013;5(Suppl 1):S128–30. <https://doi.org/10.4103/0975-7406.113313>
  41. Shah R, Shah S. Oral rehabilitation of a patient with ectodermal dysplasia: A multidisciplinary approach. *J Nat Sci Biol Med*. 2014;5(2):462–6. <https://doi.org/10.4103/0976-9668.136253>
  42. Sadashiva KM, Shetty NS, Hegde R, Karthik MM. Osseointegrated supported prosthesis and interdisciplinary approach for prosthodontic rehabilitation of a young patient with ectodermal dysplasia. *Case Rep Med*. 2013;2013:963191. <https://doi.org/10.1155/2013/963191>
  43. Galonsky VG, Radkevich AA. Complete removable dental prosthetics with the use of the materials with the memory of form. *Siberian Medical Journal (Irkutsk)*. 2007;71(4):82–7. Russian.
  44. Galonsky VG, Radkevich AA. Application of shape memory materials for the construction of pediatric dental prosthesis. *Pediatric dentistry and prophylaxis*. 2009;2(29):21–9. Russian.

45. Galonsky VG, Radkevich AA, Pulikov AS, Shushakova AA, Tarasova NV, Bril EA, et al. Clinical signs, morphology of prosthetic bed tissues, methods of rehabilitation for patients suffering from ectodermal dysplasia and congenital adentia. *Pediatric dentistry and prophylaxis*. 2011;10(4):29–41. Russian.
46. Mirgazizov MZ, Gunter VE, Galonsky VG, Sysolyatin PG, Olesova VN, Radkevich AA, et al. Gunter VE, ed. *Medical materials and implants with shape memory: in 14 vol. Vol. 5. Materials and implants with shape memory in dentistry*. Tomsk: MIZ; 2011. p. 1–220. Russian.
47. Galonsky VG, Radkevich AA, Pulikov AS, Gunter VE. Rehabilitation of adults and children with total edentulism using orthopedica construction from the “Titanide” alloy. Tomsk: publishing house «NPP MIZ»; 2009. 1–36 p. Russian.
48. Galonsky VG, Tarasova NV. Endodontic treatment of persistent teeth pulpitis: case study. *Family Health — the 21 Century*. 2013;(1):35–54. Russian.

# ANALYSIS OF THE EDUCATIONAL PROCESS WITH APPLICATION OF DISTANCE LEARNING TECHNOLOGY IN SPECIALITY 33.05.01 PHARMACY

E.V. Kharitonova<sup>1</sup>, O.L. Lopatina<sup>1,2</sup>

<sup>1</sup>Department of Biochemistry with courses of medical, pharmaceutical and toxicological chemistry, FSBEI HE Prof. V.F. Voino-Yasenetsky Krasnoyarsk State Medical University MOH Russia, Krasnoyarsk, Russian Federation

<sup>2</sup>FSAEI HE Siberian Federal University, Krasnoyarsk, Russian Federation

## Abstract

In the context of new coronavirus COVID-2019 infection spread, many students in numerous higher education institutions have undergone the transition to education applying distance learning technology while medical students undergo partially remote education. It is worth noting that in the setting of the COVID-19 pandemic, remote education is the best prevention measure for decrease in incidence of the new coronavirus infection among students.

## Keywords

remote education • e-learning • students • teachers

## Introduction

At the present time, computers and related technologies find their application in solution of many tasks. Distance education (DE) is promising for all students around the globe. Achievements in the area of information technology enhance the education process: many programs are used for e-learning. Growing interest of researchers and specialists in this area to design, development and implementation of information and communication technology is observed [1]. Application of modern software makes it possible to receive information and process in at a distance, communicate with people from any place on Earth online without leaving one's work place. More often than not, people have begun using their smartphones, tablets, laptops, etc. in order to receive information. In the past several years, such form of teacher-student communication is considered normal and is actively used in all educational institutions of the Russian Federation and the world [2].

For full-fledged learning and perception of information, both students and teachers obligatorily require modern computer platforms and access to the worldwide web as well as availability of specialised learning material in order to perform interactive classes and application of computers to their maximum potential. DE is a perfect opportunity for

knowledge level improvement and/or receipt of education by individuals incapable of daily educational facility attendance living in remote areas of Russia or even abroad [3].

However, efficacy of remote learning still remains controversial among the teachers. Application of any communication means in the educational environment may improve its efficacy for some categories of students and decrease it for the other [4].

Rostislav Fojtík has outlined main fundamental problems in implementation of distance learning technology (DLT) into the educational process by the teachers:

1. Students and many teachers have little to no experience in distance learning and teaching;
2. Teachers use the same pedagogical and didactic approaches as during in-person classes;
3. Learning requires high motivation of the students, their capability of effective time management and self-organisational skills;
4. Complex and difficult preparation of interactive learning materials;
5. Technical problems.

A survey for extramural students is presented in Table 1 [5].

**Table 1.** Main advantages and disadvantages of e-learning

Problems and complications of distance education	Advantages of distance education
1. Limited personal contact with the teacher and the groupmates	1. Possibility to learn without being distracted from the process. 1. Возможность учиться, не отрываясь от рабочего процесса.
2. Non-attendance to classical lectures and lab classes	2. Possibility to plan the learning mode individually. 2. Возможность индивидуально планировать режим обучения
3. Difficulty in correct time management.	3. Absence of the necessity to attend the educational institution on the daily basis.
4. Problems related to understanding of the learning material and keeping motivated for learning.	4. Possibility to receive tasks and send the results of their performance via the Internet.

According to the educational standard, students in speciality 33.05.01 Pharmacy have a large number of laboratory classes that are difficult to be performed through distance learning. However, the epidemiological situation evokes necessary changes in the educational process.

This work presents results of a study devoted to adaptation of teachers in speciality 33.05.01 Pharmacy to active application of distance education at the FSBEI HE Prof. V.F. Voino-Yasenetsky KrasSMU MOH Russia after six months of practice.

The aim of the study was to reveal positive and negative aspects of e-learning in the educational prospects of Pharmacy students as well as analyse problems and comments on the issue for further planning and establishment of a balance between the in-class and remote educational modes.

## Materials and Methods

Pharmacy (speciality 33.05.01) teachers (n=40) at the FSBEI HE Prof. V.F. Voino-Yasenetsky KrasSMU MOH Russia who had to work in the urgently-required mode of partially-remote education due to the COVID-19 pandemic for six month participated in the survey.

For the purpose of the research, a questionnaire containing the following items was developed:

1. How did you adapt to new conditions of distance education?
2. Is remote teaching comfortable for you?
3. What is the level of students' motivation for learning within the framework of distance education?
4. Are you satisfied with the teaching process in the remote mode?
5. In your opinion, the workload on the teachers during the lockdown has...
6. What difficulties have you encountered in the process of remote work?

7. What technical problems have you encountered in the process of remote work?
8. What form of education would you choose if you had a choice?
9. Do you think you will use educational online resources in your work after the lockdown?

Statistical analysis of the results obtained was performed with application of descriptive statistics.

## Results and Discussion

The research survey conducted has shown that the main part of the academic teaching staff (ATS) evaluated their adaptation to remote teaching as "good" (85%), 37% of the surveyed noted that this type of teaching was comfortable for them while 34% stated they had difficulties in such form of teaching. At that, 5 (14%) of the teachers mentioned absolute discomfort in application of computer technology in teaching future pharmacists. Opposite opinions were observed in the majority of the ATS regarding the satisfaction by the distance education process: 40% were more dissatisfied than not, 30 were more satisfied than not, 17% declared their complete dissatisfaction. Overall load on the teachers, according to the majority (90%) generally increased.

Large amount of homework assessment and preparation of learning materials for online classes, untimely performance of homework by students are problems intrinsic to e-learning that were noted by 70% of the teachers. Emergence of such technical problems in distance education as compromised study material playback and access to the Internet, as well as slow Internet connection speed and insufficient computer knowledge were noted by 50% of the ATS. Therewith, approximately 70% of the teachers stated they would prefer to use the traditional form of education with elements of DE in the future.

Application of distance education as an emergency measure created both problems and opportunities for many medical



schools around the globe as it has exerted influence on teachers, students, administration and auxiliary personnel. However, teaching with DLT only may lead to significant insufficiency of practical skills at the workplace in the future and affect mental health of the students negatively. In order to make the online learning package useful it must be properly composed and integrated in compliance with the educational programme. Moreover, efficacy of e-learning remains to be evaluated [6, 7].

According to Nina A. Sokolova et al., e-learning is more suitable for extramural students, for teachers who have to undergo additional training and people with health limitations. For intramural students, remote education must be supplemented with lectures and lab classes providing for the availability of in-person communication with the ATS [8].

The modern world establishes new trends in development of university teaching. In particular, it is introduction of relevant teaching methods. In this manner, the Online Journal Club is digital educational activity making it possible to perform scientific exchange using existing easily accessible technologies. Wide geographical distribution of participants in subspecialty-related classes has demonstrated the availability of such a format to the participants [9].

The COVID-19 pandemic has influenced medical and pharmaceutical education in the whole world. Unique problems related to remote high-quality training of future specialists have emerged for the first time.

## Conclusion

Over the years, DE or mixed education has been becoming increasingly required, which is mainly associated with systematic additional training for specialists or acquisition of higher education as well as development of technical capabilities.

According to results of the questionnaire for teachers in speciality 33.05.01 Pharmacy at the FSBEI HE Prof. V.F.

Voino-Yasenetsky KrasSMU MOH Russia, it is becoming obvious that:

1. Workload of the teachers has increased;
2. Technical problems exist;
3. All teachers prefer to conduct in-person classes while distance teaching cannot provide students in speciality 33.05.01 Pharmacy with comprehensive skills and abilities. Therewith, the teachers assume that partial implementation of remote technologies in the future is possible.

During the COVID-19 pandemic, e-learning and telemedicine have become ingrained in the education process of medical students and will remain important sources of medical education in the future. Deeper understanding of prospective advantages and disadvantages will make it possible for medical schools to improve the quality of e-learning.

DE has made it possible for educational establishments to maintain the knowledge acquisition process uninterrupted during the COVID-19 pandemic. The pandemic presents a unique opportunity to evaluate the significance of online-training platforms. Moreover, digitalisation of medical education may play an important role in the future of medical schools. After assessment of advantages in application of remote teaching, Smiullah Dost et al. recommend combining it with in-person classes and use online-platforms for studying making it possible for the students to digest information at their convenience and discuss the received material with the peers constructively. Apart from the COVID-19 outbreak period, introduction of online-learning methods into traditional medical and pharmaceutical education has been considered, which may contribute to a significant shift of educational practice toward virtual consultations [10].

## Conflict of Interest Statement

The authors declare no conflict of interest.

## References

1. Schneider SL, Council ML. Distance learning in the era of COVID-19. *Arch Dermatol Res.* 2020;1–2. <https://doi.org/10.1007/s00403-020-02088-9>
2. Golivkin AP. Actual problems of distance education. *StudNet.* 2020;8:419–23. Russian. <https://doi.org/10.24411/2658-4964-2020-10125>
3. Digtyar O, Fomina N, Anyushenkova O, Esina L, Zakirova E. The problems of distance learning education while teaching foreign languages at the non-linguistic higher school. *EDULEARN19 Proceedings. 11th International Conference on Education and New Learning Technologies.* Palma, Mallorca; 2019. <https://doi.org/10.21125/edulearn.2019.2658>

4. Al-Balas M, Al-Balas HI, Jaber HM, Obeidat K, Al-Balas H, Abo-rajoo EA, et al. Distance learning in clinical medical education amid COVID-19 pandemic in Jordan: current situation, challenges, and perspectives. *BMC Med Educ.* 2020;20(1):341. <https://doi.org/10.1186/s12909-020-02257-4>
5. Fojtik R. Problems of distance education. *International Journal of Information and Communication Technologies in Education.* 2018;7(1):14–23. <https://doi.org/10.2478/ijcte-2018-0002>
6. Gaur U, Majumder MAA, Sa B, Sarkar S, Williams A, Singh K. Challenges and Opportunities of Preclinical Medical Education: COVID-19 Crisis and Beyond. *SN Compr Clin Med.* 2020:1–6. <https://doi.org/10.1007/s42399-020-00528-1>
7. Wilcha RJ. Effectiveness of Virtual Medical Teaching During the COVID-19 Crisis: Systematic Review. *JMIR Med Educ.* 2020;6(2):e20963. <https://doi.org/10.2196/20963>
8. Sokolova NA, Pylkin AA, Stroganova OA, Antonian KG. The pros and cons of distance learning. *The European Proceedings of Social & Behavioural Sciences. Future Academy;* 2018. p. 1478–86. <https://dx.doi.org/10.15405/epsbs.2018.12.02.157>
9. Musits AN, Mannix AL. Synchronous Online Journal Club to Connect Subspecialty Trainees across Geographic Barriers. *West J Emerg Med.* 2020;21(1):33–6. <https://doi.org/10.5811/westjem.2019.7.43545>
10. Dost S, Hossain A, Shehab M, Abdelwahed A, Al-Nusair L. Perceptions of medical students towards online teaching during the COVID-19 pandemic: a national cross-sectional survey of 2721 UK medical students. *BMJ Open.* 2020;10(11):e042378. <https://doi.org/10.1136>

# AN OBJECTIVE METHOD FOR ASSESSMENT OF FACIAL EXPRESSION IN PATIENTS WITH PARKINSON'S DISEASE AND HEALTHY POPULATION

S.V. Prokopenko<sup>1</sup>, A.A. Khomchenkova<sup>1</sup>, V.A. Gurevich<sup>1</sup>, N.A. Butenko<sup>2</sup>, V.A. Kontorin<sup>2</sup>, A.V. Spirin<sup>2</sup>

<sup>1</sup>FSBEI HE Prof. V.F. Voyno-Yasenetsky Krasnoyarsk State Medical University MOH Russia, Krasnoyarsk, Russian Federation

<sup>2</sup>Association "Mutual Business Interests (Independent Association of Supplementary Education)", Krasnoyarsk, Russian Federation

## Abstract

Hypomimia is a common symptom of Parkinson's disease. At the present time, issues related to existence of interrelations between hypomimia and manifestations of common hypokinesia remain under-investigated in aspects of both clinical manifestations and rehabilitation efficacy. An objective method for facial muscle movement diagnostics is necessary to achieve this goal. The article presents novel experience in application of a proprietary method using objective facial expression assessment video analysis on the example of a healthy female subject and a female patient with Parkinson's disease. The Parkinson's female patient had objective symptoms of hypomimia: a decrease in velocity and amplitude of eyebrow and mouth movement, slow winking. Therefore, application of this method creates prerequisites for more in-depth study of theoretical and clinical aspects in facial expression of Parkinson's disease patients.

## Keywords

*Parkinson's disease • hypokinesia • hypomimia • video analysis of facial expression*

## Introduction

As is commonly known, hypomimia – impairment of facial expression – is among important clinical manifestations of Parkinson's disease (PD). The patient's face assumes mask-like expression, slowness and decrease amplitude of facial muscles is observed. At examination, the patient demonstrates decreased winking frequency, lowered expressiveness of eyebrow movement, weakened movement of the mouth varying from spontaneous smile impairment to half-open resting mouth [1-3]. Hypomimia combined with other motor and non-motor PD symptoms decreases the patients' quality of life [4, 5]. Decrease in facial expressiveness is assumed as manifestation of indifference and detachment by other people, which in turn leads to difficulties in social contacts and promotes appearance of anxiety and depression disorders [6-8]. Generally, facial expression is assessed subjectively [9, 10]. The most frequent method used for hypomimia degree evaluation is a fragment of the UPDRS making it possible to determine the degree of facial muscle movement impairment according to a point system with the degrees varying from 0 to 4 [11]. In clinical practice, increased facial expressiveness in the PD patient is a sign of effective dopaminergic therapy and other rehabilitation activities.

Presently, issues related to the interrelation between hypomimia and general hypokinesia remain insufficiently studied. In particular, it is not clear whether we may exert influence on manifestations of hypokinesia through facial expressiveness activation. Do such facial expressiveness activation methods exist in medical practice? There is little data available [12].

Therefore, assessment of hypomimia manifestations is possibly an important aspect in management of PD patients. A method for objective analysis of velocity and amplitude of facial muscular system movement is required in order to solve a number of clinical and theoretical problems.

The aim of the study was to create a method for objective evaluation of facial expression movements and assess its diagnostic capabilities.

## Materials and Methods

An objective method for assessment of facial expression muscles movement has been developed at the department of

neurological diseases with a course of postgraduate education at the Prof. V.F. Voyno-Yasenetsky Krasnoyarsk State Medical University in collaboration with the Association "Mutual Business Interests (Independent Association of Supplementary Education)". The method is based on computer video analysis of facial expression and is a hardware and software suite consisting of software created in the Visual Studio 2015 programming package using the PostgreSQL database management system and a video camera with the resolution of 1280x720. Assessment of facial muscle activity is performed without immediate touching and via recording of a video with a web camera. The software registers coordinates of 68 key points on the face using an open-source library of computer vision of the Python programming language. By this means, motion of eyelids, eyebrows and lips is recorded. During examination, the patient is offered to perform six diagnostic tests at the doctor's signal (see Table 1) that make it possible to evaluate the velocity and amplitude of facial muscles. A total of 10 seconds is given for performance of each of the first five tests. The text-reading test has no time restrictions.

## Results and Discussion

According to the data obtained, a digital database is formed containing all aforementioned facial movement parameters.

Below are results of facial expression video analysis results after examination of a healthy female subject aged 73 and a female PD patient aged 74 with an established diagnosis of stage 2 PD according to Hoehn and Yahr Rating Scale, akinetic-rigid-tremulous form. The disease duration was 5 years and the test was performed at the time of Levodopa dose offset (see Table 2).

As it follows from the data presented, the analysis showed significant difference between all spatial and temporal values (decrease in movement amplitude and velocity in the PD female patient). Higher indices of amplitude are observed in the healthy subject: 1.5 times higher along the X axis and 2 times higher along the Y axis. The PD patient performed 1.5 times less smiles that the healthy subject. The area of the

**Table 1.** Diagnostic tests for facial expression analysis

No	Diagnostic test	Description	Values analysed
1.	Fast smile	The patient is offered to smile as many times as possible and with the maximum amplitude	-quantity of smiles in 10 seconds -mean smile amplitude along the X axis (mm); -mean distance between the upper and the lower lips along the Y axis
2.	Letter "O"	The patient is offered to draw the letter "O" with shut pursed lips	-the area of the "O" letter drawn (mm <sup>2</sup> )
3.	Winking	The patient is offered to wink with maximum possible frequency	-quantity of winks in 10 seconds
4.	Eyebrow elevation	The patient is offered to elevate eyebrows at maximum speed and amplitude	-quantity of eyebrow elevations in 10 seconds -mean distance along the X axis (mm) -mean height of eyebrow elevation along the Y axis (mm)
5.	Frowning	The patient is offered to approximate the eyebrows and split them back at maximum speed and amplitude	- quantity of frowns in 10 seconds; - mean distance between the eyebrows
6.	Text reading	The patient is offered to read a text at a comfortable pace	-mean amplitude of the smile along the X axis (mm); -mean distance between the upper and the lower lips along the Y axis; -mean distance between the eyebrows along the X axis (mm) -mean height of eyebrow elevation along the Y axis (mm) -voice pitch (Hz)

**Table 2.** Results of the objective analysis of facial expression in a clinically healthy female subject and a female PD patient

No	Diagnostic test	Values	Healthy subject, 73 years old	PD patient, 74 years old
1.	Fast smile	X of the mouth (mm)	24.05	16.71
		Y of the mouth (mm)	21.66	10.73
		Velocity (times/10 sec)	9	6
2.	Letter "O"	S (mm <sup>2</sup> )	498	248
3.	Winking	Velocity (times/10 sec)	49	27
4.	Eyebrow elevation	X of the eyebrows (mm)	21.29	10.1
		Y of the eyebrows (mm)	23.34	12.1
		Velocity (times/10 sec)	10	7
5.	Frowning	X of the eyebrows (mm)	10.4	5.59
		Velocity (times/10 sec)	8	6
6.	Text reading	X of the mouth (mm)	10.03	6.06
		Y of the mouth (mm)	27.2	14.8
		X of the eyebrows (mm)	2.4	2.25
		Y of the eyebrows (mm)	2.4	1.24
		Pitch (Hz)	187.5	187.5

"O" letter and the winking speed was almost two times higher in the healthy subject. The eyebrow movement and frowning amplitude was reduced twofold in the female PD patient with a 1.5 times lower quantity of eyebrows elevations and insignificant difference in frowning quantity. While reading the text, the healthy subject performed twice more active lip and eyebrows motion in comparison to the PD patient.

## Conclusion

Objective facial expression evaluation revealed all main manifestations of hypomimia in the female PD patient: decrease in the amplitude and velocity of mouth and eyebrow movement and winking.

It is possible that the proprietary method of facial expression evaluation has prospects of assessment of its diagnostic value with establishment of its sensitivity and specificity as well as further implementation in clinical practice for analysis of efficacy of conducted therapy and rehabilitation. It is also planned to perform a larger-scale study on PD patients aimed at assessment of the association between hypomimia and general hypokinesia and gait impairment. The data obtained may become the basis for development of rehabilitation methods for correction of hypomimia and general hypokinesia.

## Conflict of Interest Statement

The authors declared no conflict of interest.

## References

1. Bologna M, Fabbrini G, Marsili L, Defazio G, Thompson PD, Berardelli A. Facial bradykinesia. *J Neurol Neurosurg Psychiatry*. 2013;84(6):681–5. <https://doi.org/10.1136/jnnp-2012-303993>
2. Garcia-Ruiz PJ, Feliz-Feliz CE, Maycas-Cepeda T, Del Val-Fernandez J. Amimia in Parkinson's disease. Significance and correlation with the clinical features. *Rev Neurol*. 2018;66(2):45–8. Spanish. <https://doi.org/10.33588/rn.6602.2017387>
3. Rinn WE. The neuropsychology of facial expression: a review of the neurological and psychological mechanisms for producing facial expressions. *Psychol Bull*. 1984;95(1):52–77. <https://doi.org/10.1037/0033-2909.95.1.52>
4. Kulua TK, Fedorova NV, Bril EV. Quality of life in patients with Parkinson's disease. *Pharmateca*. 2017;(20):13–8. Russian.
5. Behari M, Srivastava AK, Pandey RM. Quality of life in patients with Parkinson's disease. *Parkinsonism & related disorders*. 2005;11(4):221–6. <https://doi.org/10.1016/j.parkrel-dis.2004.12.005>
6. Kang J, Derva D, Kwon DY, Wallraven C. Voluntary and spontaneous facial mimicry toward other's emotional expression in patients with Parkinson's disease. *PLoS One*. 2019;14(4):e0214957. <https://doi.org/10.1371/journal.pone.0214957>
7. Gunnery SD, Habermann B, Saint-Hilaire M, Thomas CA, Tickle-Degnen L. The relationship between the experience of hypomimia and social wellbeing in people with Parkinson's disease and their care partners. *J Parkinsons Dis*. 2016;6(3):625–30. <https://doi.org/10.3233/JPD-160782>
8. Ma HI, Gunnery SD, Stevenson MT, Saint-Hilaire M, Thomas CA, Tickle-Degnen L. Experienced facial masking indirectly compromises quality of life through stigmatization of women and men with Parkinson's disease. *Stigma Health*. 2019;4(4):462–72. <https://doi.org/10.1037/sah0000168>
9. Ricciardi L, De Angelis A, Marsili L, Faiman I, Pradhan P, Pereira EA, et al. Hypomimia in Parkinson's disease: an axial sign responsive to levodopa. *Eur J Neurol*. 2020;27(12):2422–29. <https://doi.org/10.1111/ene.14452>
11. Özekmekçi S, Benbir G, Özdoğan FY, Ertan S, Kızıltan ME. Hemihypomimia, a rare persistent sign in Parkinson's disease: follow up of 11 patients. *J Neurol*. 2007;254(3):347–50. <https://doi.org/10.1007/s00415-006-0372-z>
12. Buck PO, Wilson RE, Seeberger LC, Conner JB, Castelli-Haley J. Examination of the UPDRS bradykinesia subscale: equivalence, reliability and validity. *J Parkinsons Dis*. 2011;1(3):253–8. <https://doi.org/10.3233/JPD-2011-11035>
13. Ricciardi L, Baggio P, Ricciardi D, Morabito B, Pomponi M, Bentivoglio AR, et al. Rehabilitation of hypomimia in Parkinson's disease: a feasibility study of two different approaches. *Neurol Sci*. 2016;37(3):431–6. <https://doi.org/10.1007/s10072-015-2421-9>



# THE ROLE OF OXIDATIVE STRESS AND ANTIOXIDANTS IN OCCURRENCE OF MYOCARDIAL INFARCTION AND CHRONIC HEART FAILURE

N.A.Terekhina<sup>1</sup>, O.G. Goryacheva<sup>1</sup>

<sup>1</sup>FSBEI HE E.A. Wagner Perm State Medical University of the Ministry of Healthcare of the Russian Federation, Perm, Russian Federation

## Abstract

Oxidative stress is one of the most important mechanisms of cardiovascular diseases, especially in heart failure. Mitochondrial dysfunction and inflammation play a major role in formation of free radicals and antioxidants. The association between oxidative stress, telomere biology and cell senescence plays the key role in cardiovascular pathology development. The paper considers role of pro-oxidant and antioxidant enzymes in heart pathology development. Specifically, the role of such antioxidant enzymes as glutathione peroxidase 3, catalase, and superoxide dismutase is described. The role of gamma-glutamyl transferase is emphasized as its activity increases significantly in cases of heart failure, coronary heart disease, stroke, arterial hypertension, and arrhythmias. This article is a literature review of the effect of such antioxidants as alpha-tocopherol, ubiquinone, uric acid, and triiodothyronine on development of heart failure and myocardial infarction. A decrease in triiodothyronine concentration is a risk factor for coronary heart disease. High uric acid values in patients with myocardial infarction upon admission to the hospital are associated with a high risk of sudden death. The influence of such minerals such as zinc, copper, magnesium, selenium, potassium, sodium, calcium, and iron on heart failure development has been analyzed. The role of ceruloplasmin as an independent predictor of acute and chronic cardiac disorders cardiac events, mortality, and bad prognosis in patients with heart failure and myocardial infarction is examined. The authors demonstrate the influence of inflammation on heart failure development as well as association of inflammation with oxidative stress.

## Keywords

heart failure • myocardial infarction • oxidative stress • inflammation • antioxidants

## Introduction

Oxidative stress is one of the most important mechanisms of human biology, especially in such cardiovascular diseases of atherosclerotic nature as coronary artery disease [1-3]. Oxidative stress plays a key role in endothelial damage, combined with  $\beta$ -oxidation of fatty acids and subsequent formation of preatherosclerotic lipid lesions in the vascular wall [1, 4]. Oxidative stress in the heart may be caused by reduced antioxidant capacity and increased production of reactive oxygen species (ROS). This may arise secondary to mechanical strain of the myocardium, neurohormonal stimulation (angiotensin II, alpha-adrenergic agonists, endothelin-1) and inflammatory cytokines (tumour necrosis factor, interleukin-1) [5, 6]. Main mechanisms of oxidative stress are localized in mitochondria in cardiomyocytes. In patients with heart failure, oxidative stress occurs in

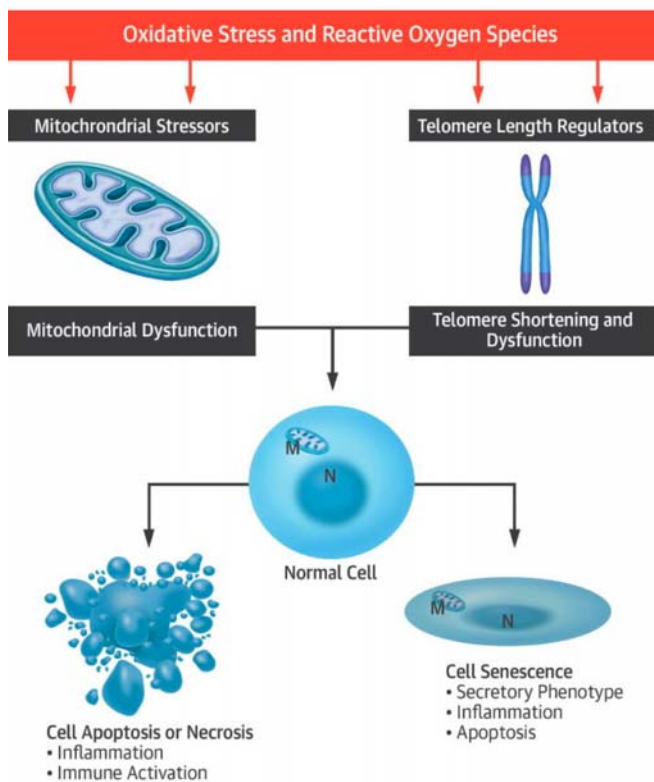
the myocardium and plasma, which correlates with left ventricular disorders (Figure 1) [7].

## Background information

### ***The role of enzymes pro- and antioxidants in development of heart failure and myocardial infarction***

The function of mitochondria is to sustain numerous homeostatic processes in the heart, including generation of energy and control of calcium metabolism and redox homeostasis [1]. The majority of free radicals in cardiomyocytes is produced in mitochondria and by nicotinamide adenine dinucleotide phosphate oxidase,

cyclooxygenase and xanthine oxidase, that contribute to production of free radicals in cardiomyocytes of patients with such complications as obesity or diabetes. Other mitochondrial proteins, such as p66shc and monoamine oxidases are also major free radicals producers as well as nitric oxide synthase [1, 8].



**Figure 1.** Mechanism of oxidative stress, based of materials of Sack MN., Fuhrquist FY, Saijonmaa OJ, Fuster V, Kovacic JC., 2017 [1]

Mitochondrial enzymes include calcium-mediated activation of isocitrate dehydrogenase, pyruvate dehydrogenase, and  $\alpha$ -ketoglutarate dehydrogenase. Thus, a small minority (<0.1%) of electrons can dissociate from the electron transfer chain and cause partial reduction of oxygen into superoxide radical and emergence of such subsequent free radicals as hydrogen peroxide and hydroxyl radicals. Mitochondria itself also contain antioxidant mechanisms to remove oxygenation of free radicals. An example of this system is superoxide dismutase enzymes that conduct dismutation of superoxide anion to hydrogen peroxide. Mitochondrial hydrogen peroxide is then catabolized by additional enzymes, including glutathione peroxidase, peroxiredoxin-3 and non-enzymatic scavengers, with its ultimate reduction to water. In cardiomyocytes *in vitro*, a high concentration of hydrogen peroxide (1mmol/l) induces myocyte autophagy.

Oxidative stress and myocyte autophagy coexist in pressure overload-induced heart failure [9]. Oxidative capacity of the cardiac muscle, mitochondrial content, and mitochondrial fusion are abnormal in elderly patients with heart failure with preserved ejection fraction and could contribute to physical load intolerance in such patients [10].

Experimental studies have demonstrated that glutathione peroxidase 3 – an antioxidant enzyme that catabolizes hydrogen peroxide – provides protection against thrombosis. Activity of glutathione peroxidase 3 progressively decreases with increasing age. Reduction of natural antioxidants may be a factor predisposing to cardiovascular complications in the elderly population [11]. The majority of experimental studies related to excess formation of mitochondrial free radicals or free radical balance disruption support the fact that it contributes to exacerbating ischemia or reperfusion injury, heart failure and diabetic cardiomyopathy. In animal models of myocardial infarction, nicotinamide adenine dinucleotide phosphate oxidase inactivation decreases the infarct lesion area and ameliorates heart failure development. However, it is unclear whether this is related to vascular or phagocytic nicotinamide adenine dinucleotide phosphate oxidases located in inflammatory cells [7].

Free radical species negatively affect disposition of myocardial calcium, generate arrhythmia, and contribute to left ventricular remodelling by inducing hypertrophic signalling, apoptosis and necrosis [7]. The beneficial effects of malonyl coenzyme A decarboxylase inhibition were attributed to a decrease in proton production due to an improved coupling between glycolysis and glucose oxidation in rats during experimental myocardial infarction [12]. All lipoproteins, proteins and nucleic acids are targets for free radical activity, which leading to their oxidative modification [1, 3, 9]. Proteins with modified amino acid residues are involved in the pathogenesis of metabolic and structural disorders in various diseases [13]. The connections between oxidative stress, telomere biology and cell senescence play the key role in formation of cardiovascular pathology. Cell division and ageing are the most important causes of telomere shortening. Oxidative stress facilitates early telomere shortening and dysfunction. Cell senescence characterised by mitotic arrest and stimuli generation of the great number of proinflammatory and growth factors, leading to an increase of tissue inflammation and oxidative stress [1]. Generation of oxidative stress mediates pathological autophagy in cardiomyocytes leading to left ventricle dysfunction and antioxidants are capable of preventing pressure overload-induced heart failure through inhibition of excessive cardiomyocyte apoptosis [9].

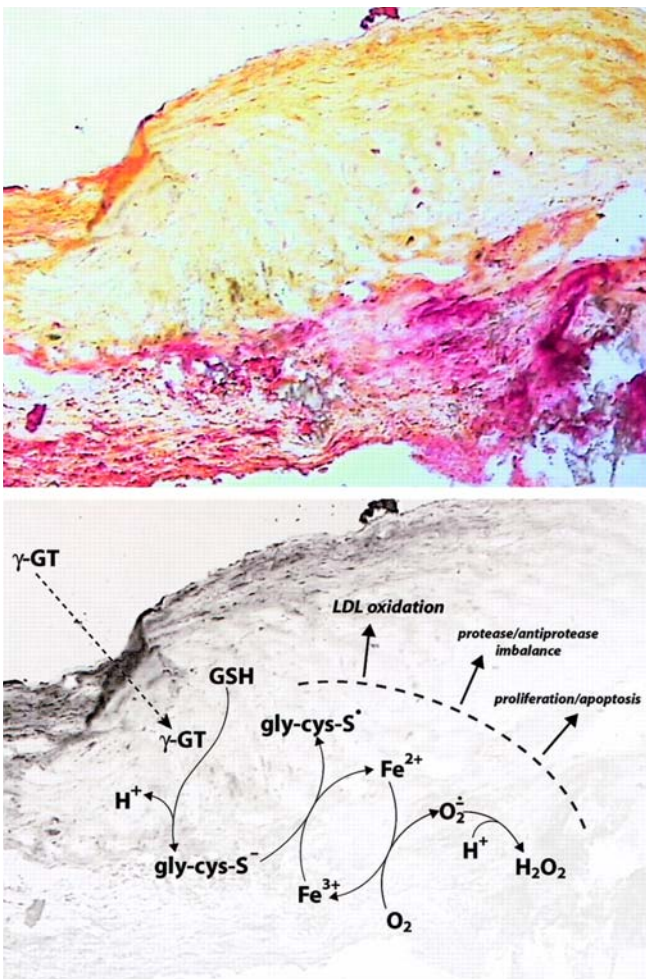
The content of lipoperoxides grows gradually from the moment of myocardial infarction occurrence over a period of 21 days. In Q-wave myocardial infarction, activity of

free radicals is higher than in non-Q-wave myocardial infarction patients [3]. Inflammation in the atherosclerotic plaque area is one of factors in atherothrombosis [14-16]. Free radicals contribute to appearance of a region of stunned myocardium around the ischemic foci and there is no contractility, conduction and excitability in that region of stunned myocardium. Mainly, the form of cell death in the heart is divided into 2 distinctly regulated molecular pathways defined as apoptosis and necrosis. Mitochondria are often part of a critical amplification loop orchestrating these cell death programmes [1]. Obesity, diabetes, smoking and pollution are prominent causes of oxidative stress in the cardiovascular system [17]. Some viruses, e.g. human immunodeficiency virus (HIV), may impair cardiac function through mitochondrial pathways. HIV infection initiates a mitochondrion-mediated cascade, releasing proteases that lead to cardiac myocyte damage and apoptosis [18, 19]. The decrease in fatty acid oxygenation contributes to contractile dysfunction of myocardium. Therefore, normalisation of fatty acid generation deficit would be assumed to improve contractility of heart [6]. Patients with heart failure have significantly higher levels of white blood cells than those with COVID-19, who do not have chronic heart failure, acute myocardial infarction or more severe complications and sudden death [20]. During the acute period of myocardial infarction, there is decreased activity of antioxidant enzymes – glutathione reductase, catalase, superoxide dismutase – in blood serum through destruction of protective mechanisms and depletion of the antioxidant pool [3, 21]. Enzymatic sources for ROS, such as the nicotinamide adenine dinucleotide phosphate oxidases, uncoupled nitric oxide synthase and mitochondria, are all considered relevant sources of free radicals in heart failure leading to vascular and myocardial dysfunction [7].

Gamma-glutamyl transferase (GGT) is a very important enzyme in metabolism of intracellular antioxidant glutathione [1, 22]. GGT is an enzyme localised on the external surface of cellular membranes. GGT contributes to maintenance of physiological concentrations of cytoplasmic glutathione and cellular defence against oxidative stress via cleavage of extracellular glutathione and increased availability of amino acids for its intracellular synthesis (Figure 2). Increased GGT activity is a marker of antioxidant inadequacy and increased oxidative stress. Elevated GGT activity is associated with increased risk of such cardiovascular diseases as coronary heart disease, stroke, arterial hypertension, heart failure, cardiac arrhythmias and all-cause or heart-related mortality [23]. The evidence is weaker for the association between elevated GGT activity and acute ischemic events or myocardial infarction. The risk of heart-related mortality mediated by

GGT may be explained by the close correlation of GGT with conventional cardiovascular disease risk factors and various comorbidities, particularly non-alcoholic fatty liver disease, alcohol consumption, oxidative stress, metabolic syndrome, insulin resistance and systemic inflammation. The finding of GGT activity in atherosclerotic plaques and correlation of intra-plaque GGT activity with histological indexes of plaque instability may suggest participation of GGT in the pathophysiology of cardiovascular diseases, particularly atherosclerosis [23]. Noteworthy is GGT activation of tyrosine kinase. Tyrosine kinase is involved in the regulation of potassium channels, expression of oxidative processes, in electrical myocardial remodelling processes after a heart attack and in heart failure development [24]. Gamma-glutamyl transpeptidase activity is used to diagnose diseases of the hepatobiliary system. The enzyme  $\gamma$ -glutamyltranspeptidase is a target for the action of various toxicants [25].

A positive correlation was established between the activity of GGT in blood serum and obesity, arterial hypertension and diabetes mellitus [26]. Results of a number of studies indicate that GGT activity correlates with the severity of coronary artery disease [22, 27-29]. The activity of the enzyme in the blood serum of patients after MI is higher than in healthy population [1, 26, 29]. An association was established between the activity of gamma-glutamyl transpeptidase and mortality from cardiovascular diseases [23, 27, 30, 31]. Enzyme activity was detected in atherosclerotic plaques of coronary and cerebral vessels [27, 32, 33]. In 2001, for the first time, G. Wannamethee et al. in the UK investigated that GGT in patients with coronary artery disease was confirmed by coronary angiography. The association between significantly increased levels of GGT activity and sudden death from heart diseases was estimated. The prognostic value of the serological activity of gamma-glutamyl transpeptidase on fatal events in coronary heart disease and chronic heart failure was confirmed [32, 34]. The effects of GGT as a pro-oxidant are evident within atherosclerotic coronary and cerebral plaques, where the enzyme was histochemically identified and retained by iron-containing proteins – transferrin, ferritin, or even free iron shown to be present in sufficient concentrations in the atherosclerotic plaque [24]. It was found that of the four available GGT fractions ( $\beta$ -, M-, S-, f-), only the  $\beta$ -fraction of GGT was found in atherosclerotic plaques [33]. GGT directly stimulates tissue factor expression in mononuclear cells of human peripheral blood through a nuclear factor kappa-light-chain-enhancer of activated B cells (NF- $\kappa$ B)-mediated mechanism and the high blood glucose level amplifies that effect. This potentially contributes to the atherothrombotic risk related to higher GGT levels, especially in diabetic patients [35].



**Figure 2.** Histochemical demonstration of GGT activity within a frozen section of coronary atheroma from endarterectomy in vivo. Histochemical reaction for GGT enzyme activity was performed with the specific substrate  $\gamma$ -glutamyl-4-methoxy-2-naphthylamide and the diazonium salt. Strong GGT activity (red stain) is selectively present in correspondence of the core of the atheroma, whereas the fibrous cap stains negative (original magnification  $\times 20$ ) [36], GGT metabolism of glutathione (GSH) within the plaque. The hydrolysis of GSH originates cysteinylglycine, which is a powerful reductant of  $\text{Fe}^{3+}$ , able to simultaneously generate  $\text{Fe}^{2+}$  and a free thiol radical, then oxygen reactive species contribute to a prooxidant effect, leading to LDL oxidation and likely contributing to other processes, such as metalloproteinase activation, cell proliferation, and apoptosis. The figure was made by Emdin M, Pompella A, Paolicchi A. [22].

**The activity of mechanisms of inflammation in the development of heart failure**

ATP-binding cassette transporter gene G1 attenuated of tumour necrosis factor  $\alpha$  induces oxidative stress and apoptosis in endothelial cells, which may involve decreased NADPH oxidase activity and expression of NADPH oxidase subunits and antioxidant superoxide dismutase 1 and 2 enzymes [37]. Interleukins IL-1, IL-2, IL-6 and  $\gamma$ -interferon may initiate

synthesis of  $\alpha$ -factor of tumour necrosis in cardiomyocytes. As a result, nitric oxide production is induced, cardiomyocytes pumping function decreases, and apoptosis is activated. There is obligatory microvascular endothelial inflammation in all patients with preserved ejection fraction heart failure [38, 39]. There is also obligatory increase in the functional class of heart failure and decrease in life quality through increase of IL-1, and soluble receptors of IL-2, IL-6 and  $\alpha$ -factor of tumour necrosis in blood [3]. Reactive radicals play a key role in the inflammatory component of atherosclerosis, where they mediate inflammation formation, which in turn supports secretion and processing of the proinflammatory cytokines interleukin (IL)-1b and IL-8 through caspase-1 activation [40]. Protein ST2 should be noted as well. It is a receptor for the family of interleukin-1 and exists in two main forms: transmembrane (ST2L) and soluble (sST2). The transmembrane form (ST2L) interacts with interleukin-33 (IL-33) forming the IL-33/ST2L complex protecting cardiomyocytes from undergoing systolic overload and prevents the development of myocardial hypertrophy [41].

**The role of ceruloplasmin in generation of heart failure and myocardial infarction**

A special place in the antioxidant system is held by ceruloplasmin - the main copper-containing glycoprotein of blood binding 90-95% of copper in serum and about 3% of all copper in the body [3, 5, 42]. In plasma, ceruloplasmin performs the function of an "interceptor" of superoxide radicals. The acute phase protein ceruloplasmin can rightfully be considered as the main antioxidant in blood plasma. Ceruloplasmin and transferrin aggregate into an antioxidant system regulating concentration of reduced ferrum (Fe) ions. Increase of ceruloplasmin in plasma of blood is and additional diagnostic marker in hypertrophic cardiomyopathy and heart failure [43]. Concentration of ceruloplasmin increases by 16% in case of myocardial infarction and by 22% in myocardial infarction complicated by severe acute left ventricle failure [44]. Patients with high content of ceruloplasmin in plasma have a higher risk of stroke or myocardial infarction [5]. Elevated ceruloplasmin levels in blood and oral fluid are associated with high risk of cardiac events including nonfatal MI, nonfatal stroke or death [18, 44]. Ceruloplasmin provides prognostic value of 5-year mortality in patients with heart failure that was independent from coronary heart disease traditional risk factors. Additionally, availability of ceruloplasmin levels can reclassify risk for 5-year mortality by 9.33%. On the other hand, strict correlation between the level of ceruloplasmin in blood serum and ejection fraction of left ventricle and brain natriuretic peptides is absent [18]. Ceruloplasmin is an independent predictor of long-term all-cause mortality in patients with heart failure. The use of ceruloplasmin



in combination with brain natriuretic peptides may help to identify patients at heightened risk of mortality from cardiovascular events [45].

#### ***The role of fat-soluble antioxidants in development of heart failure and myocardial infarction***

Reconstituted ubiquinone is a fat-soluble antioxidant that is synthesised in animal and human cells and is also constantly regenerated from the oxidized form using enzyme systems of the body. Ubiquinone is present in all cellular membranes, serum and LD-lipoproteins [46]. Ubiquinone is able to regenerate the restored form of vitamin E and correlates with the level of cholesterol [30]. Coenzyme Q deficiency indicates an unfavourable prognosis of heart failure [11]. Ubiquinone may improve endothelial dysfunction, can possibly enhance cardiac ATP production and may be an adjunctive therapeutic option for patients with heart failure with reduced ejection fraction. Evidence to support its widespread use is limited by small, heterogeneous studies [34].

A-tocopherol (Vitamin E) is a naturally occurring basic fat-soluble antioxidant and stabiliser of biological membranes. Nevertheless, upon radical-scavenging,  $\alpha$ -tocopherol itself is converted into a pro-oxidant radical (tocopheroxyl radical) potentially limiting its in vivo efficacy [7]. Alpha-tocopherol is able to integrate into the lipid layer of membranes and thereby have a membrane-protective and membrane-stabilising effect. Its high antioxidant activity is due to the hydroxyl group of the ring [3]. In the blood serum of patients with myocardial infarction, the concentration of  $\alpha$ -tocopherol decreases from the first hours of the disease remaining lowered after 24 hours [47]. Plasma  $\alpha$ -tocopherol decreases by the first day of MI, and then increases by 7 days [21]. In the study by Ruiz Rejon F. [47], there were no significant changes in the concentration of  $\alpha$ -tocopherol in the blood serum of patients with MI in the first 24 hours of the disease. However, the content of alpha-tocopherol in the blood plasma of patients with MI on days 1, 2, 3, 7, 14-16 significantly increased compared with the content of vitamin E in healthy human plasma. The maximum values of endogenous  $\alpha$ -tocopherol of blood plasma were observed on the 3rd day of myocardial infarction [48]. In patients with myocardial infarction, a decrease in the level of lipophilic antioxidants in the adipose tissue contributes to progression and complications of the disease. Administration of high doses of vitamin E worsens rather than improves the vascular function [49], which may be related to formation of the pro-oxidative vitamin E radical [50]. This may also explain why long-term treatment with vitamin E does not prevent but rather induces heart failure and acute left heart decompensation, which was shown in the HOPE (Heart Outcomes Prevention Evaluation) and HOPE-TOO (Heart Outcomes Prevention Evaluation Study-The Ongoing Outcomes) trials [37, 51].

#### ***The role of minerals in generation of heart failure and myocardial infarction***

Acute myocardial infarction is accompanied by long-term interconnected disturbances in the distribution of microelements (copper, zinc, manganese, selenium, potassium, sodium, magnesium, calcium) in the body [52]. During the acute stage of myocardial infarction, a deficit of magnesium in the blood and an increase in the concentration of iron are present [3]. There is a direct correlation between high  $Fe^{2+}$  levels, the risk of coronary heart disease and myocardial infarction. During progressive angina pectoris without development of MI, the concentration of serum iron also exceeds normal values, but does not reach the level that is observed in case of myocardial infarction [53]. Anaemia is in correlation with premature development of coronary heart disease, chronic heart failure, cardiac arrhythmias and sudden death from cardiac pathology [1, 9]. Concentrations of pro-inflammatory markers of interleukin-6, interleukin-10 and C-reactive protein in patients with myocardial infarction, along with the value of ferritin, correlate with the risk of sudden death in patients with coronary artery disease [40, 54, 55]. During a study of concentration of individual chemical elements in various parts of the hearts of patients who died from myocardial infarction, it was found that there always were 4 macroelements (sulphur, chlorine, potassium, calcium) and 13 microelements (chromium, manganese, iron, nickel, copper, zinc, selenium, bromine, rubidium, strontium, arsenic, molybdenum, mercury). Strontium, chromium and mercury were only detected in the necrosis region, which can be considered as laboratory post-mortem markers of myocardial infarction [56].

Contents of iron in peripheral blood of patients with heart failure has to be controlled as decrease of serum iron concentration is associated with duration of heart failure worsening, and intravenous injection of drugs containing iron may improve heart failure outcomes [57].

Experimental myocardial infarction revealed a significant excess of calcium concentration in myocardial tissue, which correlates with the clinical severity of the disease along with troponin, echocardiographic indicators of systolic insufficiency, and "wet" ventricular weight. At the same time, copper and selenium were recorded in high concentrations in the necrosis area [58].

Zinc – a powerful antioxidant, a component of superoxide dismutase – is crucial for protecting cardiomyocytes from damage. In patients with myocardial infarction, zinc deficiency and high concentration of copper and iron were detected in the whole blood, urine, and scalp hair [59]. The degree of zinc reduction in myocardial infarction depends on the disease severity and is more significant for large focal heart attacks, especially with the presence of arterial hypertension [60].

Copper deficiency may lead to impaired collagen synthesis

and, as a result, to atherosclerotic changes in blood vessels and hypertension through a decrease in cyclooxygenase activity. This may serve as a risk factor in development of heart hypertrophy, arrhythmias and coronary circulation disorders. A significant deficiency of copper in plasma appears with extensive Q-positive myocardial infarction. This is explained by the accumulation of copper in the myocardium and depletion of its reserves in plasma and lymph, since copper is one of vascular tone regulators [61]. In the blood of patients with pseudo infarction cardiosclerosis, copper concentration is significantly higher than in healthy ones, and zinc concentration is within normal values [59].

The antioxidant microelement cobalt increases formation of endothelial progenitor cells [62]. The presence of low concentrations of ascorbic acid in endothelial cells significantly reduces the concentration of hypoxia-inducing-factor-1- $\alpha$  associated with cobalt metabolism and protection against free radicals oxygenation. In the group of patients with acute myocardial infarction, two hours after the disease onset, the albumin-binding ability of cobalt increased significantly, while troponin had not yet responded [62]. The albumin-binding ability of cobalt can be an important diagnostic marker for acute coronary syndrome since changes in the blood only occur with myocardial ischemia [63, 64].

#### ***The role of uric acid in development of heart failure and myocardial infarction***

Uric acid has a high redox potential and is able to restore ascorbic acid. Even a moderate increase in the concentration of uric acid in blood plasma is associated with a high risk of myocardial infarction, stroke, congestive heart failure in people without heart disease [1, 65]. In chronic HF, levels of serum uric acid rise with increased purine catabolism resulting from tissue hypoxia, apoptosis, and enhanced or upregulated xanthine oxidoreductase activity [7]. The result of apoptosis and tissue hypoxia enhance purine catabolism, which in turn increases xanthine oxidase activity and subsequently serum uric acids level. Increased serum level of uric acid in the blood leads to an increase in the enzymatic activity of xanthine oxidase and increased oxidative stress forming thereby a vicious circle [8]. There is a close correlation between the concentration of uric acid in plasma and the severity of acute heart failure according to T. Killip in patients in the acute period of myocardial infarction. On admission of patients with repeated heart attacks, the concentration of uric acid was significantly higher than in patients with the first myocardial infarction. The highest level of uric acid was registered in individuals who died within 3 days from the onset of myocardial infarction with acute left ventricular insufficiency IV standard according to Killip [66]. High uric acid values in patients with myocardial infarction upon admission to the hospital are associated with a high

risk of sudden death and an unfavourable prognosis for life during the first month [67].

#### ***The role of hormones in formation of heart failure and myocardial infarction***

The thyroid hormone triiodothyronine improves myocardial contractile function and improves heart geometry in acute myocardial infarction [68]. A decrease in the concentration of triiodothyronine is a risk factor for coronary heart disease even after the exclusion of traditional risk factors [69]. Tetraiodothyronine and thyroid-stimulating hormone do not have a significant relation to prevalence of atherosclerotic plaques in coronary arteries [70]. In experimental animals (dogs and rats) with hypothyroidism, the area of myocardial infarction is larger than without hypothyroidism. After 4 weeks, animals with hypothyroidism have a more pronounced left ventricular dysfunction, large amounts of heart attack and greater final diastolic volumes of the left ventricle [70]. Changes in the level of thyroid hormones in patients with myocardial infarction and heart failure have poor prognostic value [71].

In 2018, the role of compounds that activate hypothalamus activities and cardiomyocytes proliferation in vitro was described. The authors synthesized a novel multifaceted fluorinated compound TT-10 from a biologically hit compound. The novel multifaceted fluorinated compound TT-10 showed promising features of CM proliferative, antioxidant, and antiapoptotic activities in vitro. Intraperitoneal injection of TT-10 in mice after myocardial infarction promoted proliferation of cardiomyocytes and reduced infarct size and fibrosis, which resulted in amelioration of cardiac dysfunction [72].

## **Conclusion**

Development of such acute and chronic pathology of the cardiovascular system as myocardial infarction and chronic heart failure is associated with free radical oxidation processes. The connections between oxidative stress, telomere biology, and cell senescence play the key role in formation of cardiovascular pathology. Main biochemical processes occur in the mitochondria of cardiomyocytes. Free radicals contribute to appearance of a lesion of stunned myocardium around the ischemic foci. The effects of GGT as a pro-oxidant are evident within atherosclerotic coronary and cerebral plaques, acute myocardial injury and chronic heart failure. A high dose of antioxidant vitamin E worsens rather than improves vascular function, which may be related to the formation of the pro-oxidative vitamin E radical and increase heart failure. High uric acid values in patients with myocardial infarction upon admission to the hospital are associated with a high risk of sudden death. Increase of ceruloplasmin



in plasma— additional diagnostic sign of hypertrophic cardiomyopathy and heart failure. High level of plasmas and salivates ceruloplasmin is a marker of not limited inflammation process in necrotic zone of myocardial infarction.

## Conflict of Interest Statement

The authors declare no conflict of interest.

## References

1. Sack MN, Fyhrquist FY, Saijonmaa OJ, Fuster V, Kovacic JC. Basic Biology of Oxidative Stress and the Cardiovascular System: Part 1 of a 3-Part Series. *J Am Coll Cardiol.* 2017;70(2):196–211. <https://doi.org/10.1016/j.jacc.2017.05.034>
2. Stocker R, Keaney JF Jr. Role of oxidative modifications in atherosclerosis. *Physiol Rev.* 2004;84(4):1381–478. <https://doi.org/10.1152/physrev.00047.2003>
3. Rahal A, Kumar A, Singh V, Yadav B, Tiwari R, Chakraborty S, et al. Oxidative stress, prooxidants, and antioxidants: the interplay. *Biomed Res Int.* 2014;2014:761264. <https://doi.org/10.1155/2014/761264>
4. Hill MF, Singal PK. Antioxidant and oxidative stress changes during heart failure subsequent to myocardial infarction in rats. *Am J Pathol.* 1996;148(1):291–300.
5. Zipes DP, Libby P, Bonow RO, Mann DL, Tomaselli GF, editors. Braunwald's Heart Disease: A Textbook of Cardiovascular Medicine, Single Volume. 11th edition. Elsevier; 2019. p. 1–2040.
6. Wende AR, Brahma MK, McGinnis GR, Young ME. Metabolic Origins of Heart Failure. *JACC Basic Transl Sci.* 2017;2(3):297–310. <https://doi.org/10.1016/j.jacbts.2016.11.009>
7. Münzel T, Camici GG, Maack C, Bonetti NR, Fuster V, Kovacic JC. Impact of Oxidative Stress on the Heart and Vasculature: Part 2 of a 3-Part Series. *J Am Coll Cardiol.* 2017;70(2):212–29. <https://doi.org/10.1016/j.jacc.2017.05.035>
8. Razvi S, Jabbar A, Pingitore A, Danzi S, Biondi B, Klein I, et al. Thyroid Hormones and Cardiovascular Function and Diseases. *J Am Coll Cardiol.* 2018;71(16):1781–96. <https://doi.org/10.1016/j.jacc.2018.02.045>
9. Zhu Z, Wang K, Wang J, Chi R, Yang Z, Xu H, et al. GW29-e1773 Enhanced oxidative stress mediates pathological autophagy in cardiac myocytes in pressure overload induced heart failure in rats. *J Am Coll Cardiol.* 2018;72(16):C58. <https://doi.org/10.1016/j.jacc.2018.08.212>
10. Molina AJ, Bharadwaj MS, Van Horn C, Nicklas BJ, Lyles MF, Eggebeen J, et al. Skeletal Muscle Mitochondrial Content, Oxidative Capacity, and Mfn2 Expression Are Reduced in Older Patients With Heart Failure and Preserved Ejection Fraction and Are Related to Exercise Intolerance. *JACC Heart Fail.* 2016;4(8):636–45. <https://doi.org/10.1016/j.jchf.2016.03.011>
11. Pastori D, Pignatelli P, Farcomeni A, Menichelli D, Nocella C, Carnevale R, et al. Aging-Related Decline of Glutathione Peroxidase 3 and Risk of Cardiovascular Events in Patients With Atrial Fibrillation. *J Am Heart Assoc.* 2016;5(9):e003682. <https://doi.org/10.1161/JAHA.116.003682>
12. Bloomfield GS, Alenezi F, Barasa FA, Lumsden R, Mayosi BM, Velazquez EJ. Human Immunodeficiency Virus and Heart Failure in Low- and Middle-Income Countries. *JACC Heart Fail.* 2015;3(8):579–90. <https://doi.org/10.1016/j.jchf.2015.05.003>
13. Heinecke JW. Oxidized amino acids: culprits in human atherosclerosis and indicators of oxidative stress. *Free Radic Biol Med.* 2002;32(11):1090–101. [https://doi.org/10.1016/s0891-5849\(02\)00792-x](https://doi.org/10.1016/s0891-5849(02)00792-x)
14. Chukaeva II, Orlova NV, Evdokimov FA, Aleshkin VA, Soloshenkova OO, Novikova LI, et al. Inflammation role and anti-inflammatory strategies in acute cardiovascular pathology. *Russian Journal of Cardiology.* 2009;(5):30–4. Russian. <https://doi.org/10.15829/1560-4071-2009-5-30-34>
15. Witte KK, Byrom R. Micronutrients for chronic heart failure: end of the road or path to enlightenment? *JACC Heart Fail.* 2014;2(3):318–20. <https://doi.org/10.1016/j.jchf.2014.04.001>
16. Dominguez-Rodriguez A, Abreu-Gonzalez P, Reiter RJ. Clinical aspects of melatonin in the acute coronary syndrome. *Curr Vasc Pharmacol.* 2009;7(3):367–73. <https://doi.org/10.2174/157016109788340749>
17. Niemann B, Rohrbach S, Miller MR, Newby DE, Fuster V, Kovacic JC. Oxidative Stress and Cardiovascular Risk: Obesity, Diabetes, Smoking, and Pollution: Part 3 of a 3-Part Series. *J Am Coll Cardiol.* 2017;70(2):230–51. <https://doi.org/10.1016/j.jacc.2017.05.043>
18. Terekhina NA, Goryacheva OG, Petrovich YuA, Reuk SE, Zubarev MA. The investigation of a 1-antitripsin, orozomukoid and ceruloplasmin in peripheral blood and oral fluid. parodontitis is one of more risk factors of cardiovascular diseases. *Patologicheskaya Fiziologiya i Eksperimental'naya Terapiya.* 2012;56(2):18–21. Russian.
19. Goryacheva OG, Koziolova NA. Heart failure in human immunodeficiency virus-infected patients. *Russian Journal of Cardiology.* 2020;25(1):3706. Russian. <https://doi.org/10.15829/1560-4071-2020-1-3706>
20. Zhu ZW, Tang JJ, Chai XP, Fang ZF, Liu QM, Hu XQ, et al. Comparison of heart failure and COVID-19 in chest CT features and clinical characteristics. *Zhonghua Xin Xue Guan Bing*

- Za Zhi. 2020;48(6):467–71. Chinese. <https://doi.org/10.3760/cma.j.cn112148-20200218-00093>
21. Cheng ML, Chen CM, Ho HY, Li JM, Chiu DT. Effect of acute myocardial infarction on erythrocytic glutathione peroxidase 1 activity and plasma vitamin E levels. *Am J Cardiol*. 2009;103(4):471–75. <https://doi.org/10.1016/j.amjcard.2008.09.104>
  22. Emdin M, Pompella A, Paolicchi A. Gamma-glutamyltransferase, atherosclerosis, and cardiovascular disease: triggering oxidative stress within the plaque. *Circulation*. 2005;112(14):2078–80. <https://doi.org/10.1161/CIRCULATIONAHA.105.571919>
  23. Ndrepepa G, Kastrati A. Gamma-glutamyl transferase and cardiovascular disease. *Ann Transl Med*. 2016;4(24):481. <https://doi.org/10.21037/atm.2016.12.27>
  24. Zheng MQ, Tang K, Zimmerman MC, Liu L, Xie B, Rozanski GJ. Role of gamma-glutamyl transpeptidase in redox regulation of K<sup>+</sup> channel remodeling in postmyocardial infarction rat hearts. *Am J Physiol Cell Physiol*. 2009;297(2):C253–62. <https://doi.org/10.1152/ajpcell.00634.2008>
  25. Terekhina NA, Terekhin GA, Zhidko EV, Goryacheva OG. Oxidative modification of proteins, permeability of erythrocyte membranes and activity gamma-glutamyltranspeptidase in various intoxications. *Medical science and education of Ural*. 2019;20(4):78–82. Russian.
  26. Lee DH, Silventoinen K, Hu G, Jacobs DR Jr, Jousilahti P, Sundvall J, et al. Serum gamma-glutamyltransferase predicts non-fatal myocardial infarction and fatal coronary heart disease among 28,838 middle-aged men and women. *Eur Heart J*. 2006;27(18):2170–6. <https://doi.org/10.1093/eurheartj/ehl086>
  27. Ruttman E, Brant LJ, Concin H, Diem G, Rapp K, Ulmer H. Gamma-glutamyltransferase as a risk factor for cardiovascular disease mortality: an epidemiological investigation in a cohort of 163,944 Austrian adults. *Circulation*. 2005;112(14):2130–7. <https://doi.org/10.1161/CIRCULATIONAHA.105.552547>
  28. Emdin M, Passino C, Michelassi C, Titta F, L'abbate A, Donato L, et al. Prognostic value of serum gamma-glutamyl transferase activity after myocardial infarction. *Eur Heart J*. 2001;22(19):1802–7. <https://doi.org/10.1053/euhj.2001.2807>
  29. Karlson BW, Wiklund O, Hallgren P, Sjölin M, Lindqvist J, Hertz J. Ten-year mortality amongst patients with a very small or unconfirmed acute myocardial infarction in relation to clinical history, metabolic screening and signs of myocardial ischaemia. *J Intern Med*. 2000;247(4):449–56. <https://doi.org/10.1046/j.1365-2796.2000.00679.x>
  30. Ulus T, Yildirim A, Sade LE, Temiz A, Polat E, Bozbaş H, et al. Serum gamma-glutamyl transferase activity: new high-risk criteria in acute coronary syndrome patients? *Coron Artery Dis*. 2008;19(7):489–95. <https://doi.org/10.1097/MCA.0b013e32830eab8c>
  31. Strasak AM, Kelleher CC, Klenk J, Brant LJ, Ruttman E, Rapp K, et al. Longitudinal change in serum gamma-glutamyltransferase and cardiovascular disease mortality: a prospective population-based study in 76,113 Austrian adults. *Arterioscler Thromb Vasc Biol*. 2008;28(10):1857–65. <https://doi.org/10.1161/ATVBAHA.108.170597>
  32. Franzini M, Paolicchi A, Fornaciari I, Ottaviano V, Fierabracci V, Maltinti M, et al. Cardiovascular risk factors and gamma-glutamyltransferase fractions in healthy individuals. *Clin Chem Lab Med*. 2010;48(5):713–7. <https://doi.org/10.1515/CCLM.2010.125>
  33. Sharma A, Fonarow GC, Butler J, Ezekowitz JA, Felker GM. Coenzyme Q10 and Heart Failure: A State-of-the-Art Review. *Circ Heart Fail*. 2016;9(4):e002639. <https://doi.org/10.1161/CIRCHEARTFAILURE.115.002639>
  34. Tereshchenko SN, Zhironov IV, Nasonova SN, Nikolaeva OA, Led'yakhova MV. Pathophysiology of acute heart failure. What's new? *Russian Journal of Cardiology*. 2016;9(137):52–64. Russian. <https://doi.org/10.15829/1560-4071-2016-9-52-64>
  35. Irving BA, Lanza IR, Henderson GC, Rao RR, Spiegelman BM, Nair KS. Combined training enhances skeletal muscle mitochondrial oxidative capacity independent of age. *J Clin Endocrinol Metab*. 2015;100(4):1654–63. <https://doi.org/10.1210/jc.2014-3081>
  36. Paolicchi A, Emdin M, Ghiozeni E, Ciancia E, Passino C, Popoff G, et al. Images in cardiovascular medicine. Human atherosclerotic plaques contain gamma-glutamyl transpeptidase enzyme activity. *Circulation*. 2004;109(11):1440. <https://doi.org/10.1161/01.CIR.0000120558.41356.E6>
  37. Xue J, Huang H, Zhu C. GW28-e1203 ABCG1 attenuates Oxidative Stress Induced by TNF- $\alpha$  through the inhibition of NADPH oxidase and the upregulation of antioxidant enzymes in endothelial cells. *J Am Coll Cardiol*. 2018;70(16S):C46–7. <https://doi.org/10.1016/j.jacc.2017.07.160>
  38. Franssen C, Chen S, Unger A, Korkmaz HI, De Keulenaer GW, Tschöpe C, et al. Myocardial Microvascular Inflammatory Endothelial Activation in Heart Failure With Preserved Ejection Fraction. *JACC Heart Fail*. 2016;4(4):312–24. <https://doi.org/10.1016/j.jchf.2015.10.007>
  39. Harouki N, Nicol L, Remy-Jouet I, Henry JP, Dumesnil A, Lejeune A, et al. The IL-1 $\beta$  Antibody Gevokizumab Limits Cardiac Remodeling and Coronary Dysfunction in Rats With Heart Failure. *JACC Basic Transl Sci*. 2017;2(4):418–30. <https://doi.org/10.1016/j.jacbs.2017.06.005>
  40. Li H, Horke S, Förstermann U. Vascular oxidative stress, nitric oxide and atherosclerosis. *Atherosclerosis*. 2014;237(1):208–19. <https://doi.org/10.1016/j.atherosclerosis.2014.09.001>
  41. Ghafourian K, Shapiro JS, Goodman L, Ardehali H. Iron and Heart Failure: Diagnosis, Therapies, and Future Directions. *JACC Basic Transl Sci*. 2020;5(3):300–13. <https://doi.org/10.1016/j.jacbs.2019.08.009>
  42. Terekhina NA, Petrovich YuA. Free radical oxidation and antioxidant system. *Perm*; 2005. p. 1–57. Russian.
  43. Kennedy DJ, Fan Y, Wu Y, Pepoy M, Hazen SL, Tang WH. Plasma ceruloplasmin, a regulator of nitric oxide activity, and incident cardiovascular risk in patients with CKD. *Clin J Am Soc Nephrol*. 2014;9(3):462–7. <https://doi.org/10.2215/CJN.07720713>

44. Jenkins DJA, Spence JD, Giovannucci EL, Kim YI, Josse R, Vieth R, et al. Supplemental Vitamins and Minerals for CVD Prevention and Treatment. *Am Coll Cardiol*. 2018;71(22):2570–84. <https://doi.org/10.1016/j.jacc.2018.04.020>
45. Rosano GM, Vitale C. Metabolic Modulation of Cardiac Metabolism in Heart Failure. *Card Fail Rev*. 2018;4(2):99–103. <https://doi.org/10.15420/cfr.2018.18.2>
46. Molyneux SL, Florkowski CM, George PM, Pilbrow AP, Frampton CM, Lever M, et al. Coenzyme Q10: an independent predictor of mortality in chronic heart failure. *J Am Coll Cardiol*. 2008;52(18):1435–41. <https://doi.org/10.1016/j.jacc.2008.07.044>
47. Ruiz Rejón F, Martín-Peña G, Granado F, Ruiz-Galiana J, Blanco I, Olmedilla B. Plasma status of retinol, alpha- and gamma-tocopherols, and main carotenoids to first myocardial infarction: case control and follow-up study. *Nutrition*. 2002;18(1):26–31. [https://doi.org/10.1016/s0899-9007\(01\)00683-9](https://doi.org/10.1016/s0899-9007(01)00683-9)
48. Terekhina NA, Goryacheva OG. Influence of heart failure severity on the content of alpha-tocopherol in erythrocytes of blood in myocardial infarction. *Medical alphabet*. 2015;1(2):52–3. Russian.
49. Keaney JF Jr, Gaziano JM, Xu A, Frei B, Curran-Celentano J, Shwaery GT, et al. Low-dose alpha-tocopherol improves and high-dose alpha-tocopherol worsens endothelial vasodilator function in cholesterol-fed rabbits. *J Clin Invest*. 1994;93(2):844–51. <https://doi.org/10.1172/JCI117039>
50. Stocker R. The ambivalence of vitamin E in atherogenesis. *Trends Biochem Sci*. 1999;24(6):219–23. [https://doi.org/10.1016/s0968-0004\(99\)01404-8](https://doi.org/10.1016/s0968-0004(99)01404-8)
51. Lonn E, Bosch J, Yusuf S, Sheridan P, Pogue J, Arnold JM, et al. Effects of long-term vitamin E supplementation on cardiovascular events and cancer: a randomized controlled trial. *JAMA*. 2005;293(11):1338–47. <https://doi.org/10.1001/jama.293.11.1338>
52. Fiarresga AJ, Feliciano J, Fernandes R, Martins A, Pelicano N, Timóteo AT, et al. Relationship between coronary disease and subclinical hypothyroidism: an angiographic study. *Rev Port Cardiol*. 2009;28(5):535–43.
53. Depalma RG, Hayes VW, Chow BK, Shamayeva G, May PE, Zacharski LR. Ferritin levels, inflammatory biomarkers, and mortality in peripheral arterial disease: a substudy of the Iron (Fe) and Atherosclerosis Study (FeAST) Trial. *J Vasc Surg*. 2010;51(6):1498–503. <https://doi.org/10.1016/j.jvs.2009.12.068>
54. Shreider EV, Shakhnovich Rm, Kaznacheeva EI, Bosykh EG, Tkachev GA, Ruda Mla. Comparative dynamics of markers of inflammation and NT-proBNP in different variants of treatment of patients with ACS. *Kardiologija*. 2008;48(8):20–7. Russian.
55. Okuneva GN, Chernyavsky AM, Levicheva EN, Loginova IYu, Volkov AM, Trunova VA, et al. Content of microelements in left ventricular myocardium of patients with ischemic heart disease. Data of roentgenofluorescent analysis with the use of synchrotron irradiation. *Kardiologija*. 2006;46(10):13–7. Russian.
56. Mladenka P, Hrdina R, Bobrovová Z, Semecky V, Vávrová J, Holecková M, et al. Cardiac biomarkers in a model of acute catecholamine cardiotoxicity. *Hum Exp Toxicol*. 2009;28(10):631–40. <https://doi.org/10.1177/0960327109350665>
57. Jankowska EA, von Haehling S, Anker SD, Macdougall IC, Ponikowski P. Iron deficiency and heart failure: diagnostic dilemmas and therapeutic perspectives. *Eur Heart J*. 2013;34(11):816–29. <https://doi.org/10.1093/eurheartj/ehs224>
58. Kazi TG, Afridi HI, Kazi N, Jamali MK, Arain MB, Sarfraz RA, et al. Distribution of zinc, copper and iron in biological samples of Pakistani myocardial infarction (1st, 2nd and 3rd heart attack) patients and controls. *Clin Chim Acta*. 2008;389(1–2):114–9. <https://doi.org/10.1016/j.cca.2007.12.004>
59. Shokrzadeh M, Ghaemian A, Salehifar E, Aliakbari S, Saravi SS, Ebrahimi P. Serum zinc and copper levels in ischemic cardiomyopathy. *Biol Trace Elem Res*. 2009;127(2):116–23. <https://doi.org/10.1007/s12011-008-8237-1>
60. Hoenig MR, Bianchi C, Sellke FW. Hypoxia inducible factor-1 alpha, endothelial progenitor cells, monocytes, cardiovascular risk, wound healing, cobalt and hydralazine: a unifying hypothesis. *Curr Drug Targets*. 2008;9(5):422–35. <https://doi.org/10.2174/138945008784221215>
61. Lele S, Shah S, McCullough PA, Rajapurkar M. Serum catalytic iron as a novel biomarker of vascular injury in acute coronary syndromes. *EuroIntervention*. 2009;5(3):336–42. <https://doi.org/10.4244/e5i3a53>
62. Qiao H, Li L, Qu ZC, May JM. Cobalt-induced oxidant stress in cultured endothelial cells: prevention by ascorbate in relation to HIF-1alpha. *Biofactors*. 2009;35(3):306–13. <https://doi.org/10.1002/biof.43>
63. Bhagavan NV, Lai EM, Rios PA, Yang J, Ortega-Lopez AM, Shinoda H, et al. Evaluation of human serum albumin cobalt binding assay for the assessment of myocardial ischemia and myocardial infarction. *Clin Chem*. 2003;49(4):581–5. <https://doi.org/10.1373/49.4.581>
64. Holme I, Aastveit AH, Hammar N, Jungner I, Walldius G. Uric acid and risk of myocardial infarction, stroke and congestive heart failure in 417,734 men and women in the Apolipoprotein MORTALITY RISK study (AMORIS). *J Intern Med*. 2009;266(6):558–70. <https://doi.org/10.1111/j.1365-2796.2009.02133.x>
65. Nadkar MY, Jain VI. Serum uric acid in acute myocardial infarction. *J Assoc Physicians India*. 2008;56:759–62.
66. Car S, Trkulja V. Higher serum uric acid on admission is associated with higher short-term mortality and poorer long-term survival after myocardial infarction: retrospective prognostic study. *Croat Med J*. 2009;50(6):559–66.
67. Dan GA. Thyroid hormones and the heart. *Heart Fail Rev*. 2016;21(4):357–9. <https://doi.org/10.1007/s10741-016-9555-6>
68. Coceani M, Iervasi G, Pingitore A, Carpeggiani C, L'Abbate A. Thyroid hormone and coronary artery disease: from clinical correlations to prognostic implications. *Clin Cardiol*. 2009;32(7):380–5. <https://doi.org/10.1002/clc.20574>
69. Yaman B, Cerit L, Günşel HK, Günşel A, Usalp S, Yüsek Ü, et al. Association between subclinical hypothyroidism and coronary

- artery disease. *Progress in Nutrition*. 2019;21(4):871–5. <https://doi.org/10.23751/pn.v21i4.7979>
70. Chen YF, Redetzke RA, Said S, Beyer AJ, Gerdes AM. Changes in left ventricular function and remodeling after myocardial infarction in hypothyroid rats. *Am J Physiol Heart Circ Physiol*. 2010;298(1):H259–62. <https://doi.org/10.1152/ajp-heart.00755.2009>
71. Wang W, Zhang L, Battiprolu PK, Fukushima A, Nguyen K, Milner K, et al. Malonyl CoA decarboxylase Inhibition improves cardiac function post-myocardial infarction. *JACC Basic Transl Sci*. 2019;4(3):385–400. [doi.org/10.1016/j.jacbts.2019.02.003](https://doi.org/10.1016/j.jacbts.2019.02.003)
72. Freaney PM, Shah SJ, Khan SS. COVID-19 and Heart Failure With Preserved Ejection Fraction. *JAMA*. 2020;324(15):1499–1500. <https://doi.org/10.1001/jama.2020.17445>

# PANTON-VALENTINE LEUKOCIDIN-POSITIVE METHICILLIN-RESISTANT STAPHYLOCOCCUS AUREUS WITH REDUCED VANCOMYCIN SUSCEPTIBILITY: AN EMERGING TREND?

Tatsuo Yamamoto<sup>1,2</sup>, Olga E. Khokhlova<sup>1,2</sup>, Tsai-Wen Wan<sup>1,3</sup>, Darya N. Akhusheva<sup>2</sup>, Ivan V Reva<sup>1</sup>, Olga V. Peryanova<sup>2</sup>, Lee-Jene Teng<sup>3</sup>

<sup>1</sup>Department of Epidemiology, Genomics, and Evolution, International Medical Education and Research Center, Niigata, Japan

<sup>2</sup>Russia-Japan Laboratory of Microbiology, Metagenomics, Federal State Budgetary Educational Institution of Higher Education «Prof. V.F. Voynov-Yasenetsky Krasnoyarsk State Medical University» of the Ministry of Healthcare of the Russian Federation, Krasnoyarsk, Russian Federation

<sup>3</sup>Department of Clinical Laboratory Sciences and Medical Biotechnology, National Taiwan University College of Medicine, Taipei, Taiwan

## Abstract

Methicillin-resistant *Staphylococcus aureus* (MRSA) is a major multidrug-resistant nosocomial pathogen. This class of MRSA, first reported in the early 1960s and now termed healthcare-associated MRSA (HA-MRSA), was followed by a newer class of MRSA, community-associated MRSA (CA-MRSA). The unique feature of the initial CA-MRSA included Panton-Valentine leukocidin (PVL), an abscess-associated toxin and also *S. aureus* spread factor. CA-MRSA usually causes skin and soft-tissue infections, but occasionally causes invasive infections, including (necrotizing) pneumonia, sometimes preceded by respiratory virus infections. The most successful CA-MRSA USA300 (ST8/SCCmecIVa) caused an epidemic in the United States. In Russia, we first detected PVL-positive CA-MRSA (ST30/SCCmecIVc) in Vladivostok in 2006, but with no more PVL-positive MRSA isolation. However, we recently isolated four lineages of PVL-positive MRSA in Krasnoyarsk. Regarding chemotherapy against invasive MRSA infections, vancomycin still remains a gold standard, in addition to some other anti-MRSA agents such as teicoplanin, linezolid, and daptomycin. For resistance, vancomycin-resistant MRSA (VRSA) with MICs of  $\geq 16$   $\mu\text{g}/\text{mL}$  appeared in patients, but cases are still limited. However, clinically, infections from strains with MICs of  $\geq 1.5$   $\mu\text{g}/\text{mL}$ , even albeit with susceptible MICs ( $\leq 2$   $\mu\text{g}/\text{mL}$ ), respond poorly to vancomycin. Some of those bacteria have been bacteriologically characterized as vancomycin-intermediate *S. aureus* (VISA) and heterogeneous VISA (hVISA), generally with HA-MRSA genetic backgrounds. The features of the above PVL-positive Krasnoyarsk MRSA include reduced susceptibility to vancomycin, which meets the criteria of hVISA. In this review, we discuss a possible new trend of PVL-positive hVISA, which may spread and threaten human health in community settings.

## Keywords

methicillin-resistant *Staphylococcus aureus* (MRSA) • Panton-Valentine leukocidin (PVL) • heterogeneous vancomycin-intermediate *S. aureus* (hVISA) • genotype • community setting • bacterial cell structure • oxacillin/imipenem/meropenem resistance

## Introduction

Methicillin-resistant *Staphylococcus aureus* (MRSA) is a major multidrug-resistant (MDR) pathogen [1-5], once again recognized by the World Health Organization (WHO) in 2014 [6]. The term MRSA includes healthcare-associated MRSA (HA-MRSA) and community-associated MRSA (CA-MRSA) [1-3]. HA-MRSAs, emerging in the early 1960s, are most frequently associated with infections in hospital in-patients (particularly the elderly), such as ventilator-associated pneumonia, bloodstream infections, catheter-associated urinary tract infections, surgical site infections

[1, 3, 7, 8]. They are usually resistant to antibacterial drugs frequently used in hospital settings, such as fluoroquinolones [1, 3, 4]. HA-MRSA lineages include, for example, ST239/SCCmecIII and ST5/SCCmecII [9, 10]; SCCmecII and SCCmecIII are associated with HA-MRSA [2, 3, 11].

CA-MRSA has been noted more recently than HA-MRSA, since 1997-1999 [12]. CA-MRSA infections occur in healthy individuals in community settings (including children [1, 3, 7] and athletes [13]), usually causing skin and soft-



tissue infections (SSTIs), but occasionally causing invasive infections, including (necrotizing) pneumonia, sometimes preceded by respiratory virus infections [1, 3, 14-16]. They usually display less MDR pathogens [3], and include, for example, ST8/SCC*mecIVa* (USA300) [1, 3, 14, 17], ST30/SCC*mecIV* [2, 18], ST59/SCC*mecV* [2, 19], and ST80/SCC*mecIV* [2, 20]; SCC*mecIV* and SCC*mecV* are associated with CA-MRSA [2, 3, 11]. USA300 caused an epidemic of serious invasive infections in the United States in 2007, progressing to a nosocomial MDR pathogen and a global pathogen [15, 17, 21, 22].

CA-MRSA often produces Panton-Valentine leukocidin (PVL), which is an abscess-associated toxin [23] and also spread factor [24] of *S. aureus*. In Russia, we first detected PVL-positive MRSA with a global genotype, ST30/SCC*mecIVc*, in Vladivostok in 2006 [25]. Recently in many countries, MRSA incidences have been declining, while the proportion of CA-MRSA genotypes is increasing [26].

Invasive infections with MRSA are treated with anti-MRSA agents, such as vancomycin and teicoplanin (glycopeptides), linezolid (oxazolidinones), daptomycin (calcium-dependent cyclic lipopeptides), and arbekacin (aminoglycosides) [27, 28]. Although vancomycin has been known since the beginning of the 1980s as the drug of last resort in treating MRSA infections, vancomycin still remains the gold standard for invasive MRSA therapy [27, 28]. Regarding the susceptibility of *S. aureus* to vancomycin, the Clinical and Laboratory Standards Institute (CLSI) [29] defined MICs  $\geq 16$   $\mu\text{g}/\text{mL}$  as resistant (*S. aureus* as VRSA [30]), MICs of 4 and 8  $\mu\text{g}/\text{mL}$  as intermediate (*S. aureus* as VISA [31-33]), and MICs  $\leq 2$   $\mu\text{g}/\text{mL}$  as susceptible. Thus, VISA is detected according to the CLSI procedure. However, it has been reported that infections involving *S. aureus* with MICs  $\geq 1.5$   $\mu\text{g}/\text{mL}$  respond poorly to vancomycin [34]. MRSA cases of reduced susceptibility to vancomycin has been reported worldwide [35, 36], albeit with no cases [37].

The Hiramatsu group defined the third category of vancomycin resistance, heterogeneous VISA (hVISA), which shows susceptible MICs ( $\leq 2$   $\mu\text{g}/\text{mL}$ ), but produces VISA cells in its cell population at a frequency of  $10^{-6}$  or greater [38]. The reported detection methods of hVISA include, for example, macro Etest method [39], population analyses profile-area under curve (PAP-AUC) method [32, 40-42], and micro broth dilution method [43]. hVISA is not routinely diagnosed in clinical labs. They generally report, based on their experiences, that the phenotypes may be unstable, and some of the isolated hVISA cells easily become susceptible during storage. In this review, an attempt was made to discuss a new possible trend of PVL-positive hVISA, based on those that emerged in Krasnoyarsk, Russia.

## Methods

Our epidemiological and experimental data on Krasnoyarsk isolates are used as the bases for this review. Table 1 and Table 2 [44-51], respectively, summarize the methods of susceptibility testing and MRSA strains used in this study. For analysis, the PVL-positive and vancomycin-susceptible CA-MRSA strain RS08 (ST30/SCC*mecIVc*) from Vladivostok [25], and PVL-negative and vancomycin-susceptible CA-MRSA strain OC8 (ST8/SCC*mecIVc*) [44, 45] and HA-MRSA strain OC3 (ST239/SCC*mecIIIa*[3A&5]) [44] from Krasnoyarsk were used as reference strains (Table 2). VISA strain Mu50 [32, 46-49] and hVISA strain Mu3 [32, 50] were also used as reference strains (Table 2); Mu50 and Mu3 were kindly provided by K. Hiramatsu (Juntendo University, Tokyo, Japan). In susceptibility testing, we used Mueller-Hinton (MH) agar and the results (MICs) were recorded after incubation for 18-24 hours (Table 1), as described by the Clinical and Laboratory Standards Institute (CLSI) [29], unless otherwise noted. *S. aureus* ATCC29213 was used as an MIC standard strain [29]. In this study, MRSA clinical isolates with a vancomycin MIC of 3  $\mu\text{g}/\text{mL}$  were classified as hVISA, higher vancomycin MIC mutants (hVISA<sub>v</sub>) were derived, similarly to a hVISA Mu3 case, and characteristics of hVISA and hVISA<sub>v</sub> were examined in detail. Data published by others are also used to evaluate our data and to extend our discussion.

## Results and Discussion

MRSA was isolated from prisoners and also healthy hospital workers in Krasnoyarsk; four strains of PVL-positive MRSA were detected, two from prisoners (frequency, 2/5 [2 out of 5 MRSA; MRSA being obtained from 246 prisoners]) and two from healthy hospital workers (frequency, 2/8 [2 out of 8 MRSA; MRSA being obtained from 2,076 staffs]). The relevant characteristics of MRSA strains used in this study are summarized in Table 2. The four PVL-positive MRSA strains from Krasnoyarsk are of divergent genotypes: ST1, ST30, ST152, and ST154. The genotypes of 0380 (ST30/SCC*mecIV*) and 0409 (ST1/SCC*mecIV*), together with their PVL gene carriage, suggest that they are CA-MRSA lineages. Both 0380 and 0409 were isolated from a nasal carrier; 0380 being isolated from a healthy hospital worker, but 0409 from a HIV-infected prisoner (prison inmates) with furunculosis. Prisoners are at a high risk for CA-MRSA infections [7, 52].

Strain 0409 unusually exhibits high MIC values for oxacillin and imipenem/meropenem (carbapenems) (Table 2), which



are the characteristics of HA-MRSA [53]. The carrier (SSTI patient) has not been at risk of HA-MRSA within the last year [1]. Strain 0409 must have been selected on a large scale and on the long term use of drugs, such as cephalosporins or carbapenems. Alternatively, transmission of the selected strain may have occurred. We already reported a case of the Russian ST8/SCC*mecIVc* CA-MRSA lineage with HA-MRSA-like high MICs for oxacillin ( $\geq 256$   $\mu\text{g/mL}$ ) and imipenem (16  $\mu\text{g/mL}$ ) [45]. Therefore, this represents the second case.

Regarding the oxacillin/imipenem resistance levels of HA-MRSA, progression occurred from MIC<sub>50</sub> 0.2  $\mu\text{g/mL}$  and MIC<sub>90</sub> 12.5  $\mu\text{g/mL}$  in 1976 to 1989 to MIC<sub>50</sub>  $\geq 100$   $\mu\text{g/mL}$  and MIC<sub>90</sub>  $\geq 100$   $\mu\text{g/mL}$  in 1990 and 1991, respectively [53]. At that time, we pointed out the possibility that in the future, CA-MRSA could also manifest higher oxacillin and imipenem resistance. This is indeed occurring in current CA-MRSA lineages.

PVL-positive CA-MRSA ST152 and ST154 lineages have also been clinically isolated albeit generally to a lesser extent. For example, cases of ST152 isolation include ST152 from Austria [54], ST152/SCC*mecV* from Switzerland [55], ST152/spat454 from Slovenia [56], and ST152/SCC*mecNT* (nontypeable) from Denmark [57] and Sweden [58]. For ST154, isolation cases include ST154/SCC*mecIVNT* (subtype, nontypeable) from Ireland [59] and Japan [60], ST152/SCC*mecNT* from Sweden [58], ST154/SCC*mec-Hg* (SCC*mecIV* [2B&5]) from the Czech Republic [61], and ST154/SCC*mecIVc* from Mongolia [62]. ST154/SCC*mecNT* was also reported in Finland, but as a HA-MRSA lineage [63]; it is resistant to chloramphenicol, which is commonly used in the community, because of its low price and the absence of a need for a doctor's prescription, in some countries/areas, including Krasnoyarsk, Russia, but it has resulted in the appearance of a chloramphenicol resistance plasmid [44].

In our case, strain 0553 (ST154/SCC*mecNT*) was isolated from the nasal mucosa of a healthy hospital worker, and strain 0579 (ST152/SCC*mecNT*) was from the purulent wound (pus) of a HIV-infected prisoner (Table 1). Both 0553 and 0579 exhibit low MIC values for oxacillin and carbapenems, in agreement with the characteristics of CA-MRSA [53], and also the carrier and patient have not been at risk of HA-MRSA within the last year [1], suggesting that the two strains are CA-MRSA. The SCC*mec* types or SCC*mecIV* subtypes of the four PVL-positive MRSA strains from Krasnoyarsk (Table 1) remain to be examined.

PVL-positive CA-MRSA still spreads worldwide. In Japan, it is mainly associated with deep-seated skin infections in communities (PVL+/total MRSA, 13.2%), surprisingly reaching 93.8% in Ishigaki island in Okinawa [64]; it also spreads among HIV-infected people in Tokyo [65]. In Canada,

PVL-positive CA-MRSA accounts for 78.4% of the CA-MRSA genotypes and 1.7% of the HA-MRSA genotypes [26].

VISA strain Mu50 and hVISA strain Mu3, used as reference strains, belong to the common HA-MRSA lineage (ST5/SCC*mecII*) in Japan, which is often called the New York/Japan clone [10, 66, 67]; the two strains exhibit high oxacillin and imipenem MICs (Table 2). OC8 and OC3, respectively, are representative strains of the unique ST8 CA-MRSA (ST8<sub>Kras</sub>) [44, 45] and unique ST239 HA-MRSA (ST239<sub>Kras</sub>) [44] distributed to Krasnoyarsk, with both being resistant to levofloxacin and chloramphenicol, ST8<sub>Kras</sub> possesses a one-megabase genomic inversion and exhibits low oxacillin and imipenem MICs, and ST239<sub>Kras</sub> carries the staphylococcal superantigen gene (toxic shock syndrome toxin-1 [TSST-1] gene, *tst*) on SaPI and exhibits high oxacillin and imipenem MICs. RS08 is from Vladivostok, and is the first PVL-positive CA-MRSA isolate from Russia [25]; RS08 exhibits low oxacillin and imipenem MICs and is susceptible to levofloxacin, chloramphenicol, and vancomycin.

All four PVL-positive Krasnoyarsk MRSA exhibited hVISA MICs (vancomycin MIC, 3  $\mu\text{g/mL}$ ) (Table 2). However, after storage of the bacterial strains at  $-80^{\circ}\text{C}$ , they turned out to be vancomycin MIC 1  $\mu\text{g/mL}$ , which is a susceptible level (Table 3), suggesting that the hVISA phenotypes are unstable. Strain Mu3, stored at  $-80^{\circ}\text{C}$ , also produced the same vancomycin MIC level of 1  $\mu\text{g/mL}$  (Table 3). In some published papers [50], vancomycin MICs are examined using brain heart infusion (BHI) agar, instead of MH agar, and involve a prolonged incubation time. So, we also examined them using BHI agar, resulting in two-fold higher vancomycin MICs, 2  $\mu\text{g/mL}$ , for the four PVL-positive Krasnoyarsk MRSA and Mu3 (Table 3). Vancomycin MIC of 2  $\mu\text{g/mL}$  for Mu3 is also reported by others [38]. There is cross-resistance between structurally-related vancomycin and teicoplanin (glycopeptides). However, the four Krasnoyarsk hVISA exhibited lower teicoplanin MICs, compared with those of Mu3, suggesting the presence of divergent genetic backgrounds between the two. Vancomycin MICs for Mu50, stored at  $-80^{\circ}\text{C}$ , were 2  $\mu\text{g/mL}$  on MH agar and 4  $\mu\text{g/mL}$  on BHI agar (Table 3); the data were also slightly lower compared with reported data [50]. VISA cells (bacterial cells exhibiting a lower susceptibility to vancomycin) included in hVISA cultures can be identified by population analysis called PAP-AUC [32, 40-42]. So, next, we performed population analysis, and colonies (mutants) that developed on MH agar containing vancomycin at 4  $\mu\text{g/mL}$  were obtained: 0409v was obtained from the 0409 MH broth cultures at a frequency of  $1.5 \times 10^{-8}$ , Mu3v was from the Mu3 MH broth cultures at a frequency of  $4.8 \times 10^{-8}$ , and Mu50v was from the Mu50 MH broth cultures at a frequency of  $3.2 \times 10^{-6}$ . Thus, the 0409 has a similar potential to

produce vancomycin lower-susceptibility mutants, compared with Mu3. 0409v exhibited two or four-fold higher MIC values than 0409 for vancomycin and teicoplanin (glycopeptides), and these data are similar to those of Mu3v, as shown in Table 3. Regarding daptomycin MICs, 0409v, Mu3v, and Mu50v all exhibited two-fold higher MICs, compared with their original strains (0409, Mu3, and Mu50) (Table 3).

Next, the bacterial cell structures of the 0409 and 0409v, which were stored at  $-80^{\circ}\text{C}$  and grown on sheep blood agar plates, were analyzed by scanning electron microscopy (SEM) and transmission electron microscopy (TEM) (Fig. 1). The 0409 cells (Fig. 1A and B) still has a thick septum, the characteristic structure of VISA (Fig. 1Bb, arrow); the structure is considered to be responsible for vancomycin-intermediate phenotype, because vancomycin's approach to the target site of cell wall synthesis is prevented through the thick division septum [31].

In addition, in contrast to the 0409 (Fig. 1 A and B), 0409v shows an abnormal cell surface with accumulated cell walls along the cell separation site or the irregular, multiple cross-like structure (Fig. 1C and D) and also abnormal septum formation (Fig. 1 Cb, Db, and Dc). In addition, the cell wall thickness, observed in TEM, were approximately 35% increased in 0409v.

When the bacterial cell structures of the Mu3 and Mu3v, which were stored at  $-80^{\circ}\text{C}$  and grown on sheep blood agar plates, were analyzed by SEM, abnormal cell surface with accumulated cell walls along the cell separation site or the irregular, multiple cross-like structures was observed for the Mu3v, but to a lesser extent (Fig. 2B).

Colonies of the 0380, 0553, and 0579, which were stored at  $-80^{\circ}\text{C}$  and grown on sheep blood agar plates, were also analyzed by SEM (Fig. 3). The 0380, 0553, and 0579 produced a sticky intercellular substance, spreading among the cells (Fig. 3A, B, Ca); which may be similar to that reported in *S. aureus* small colony variants (SCVs) [68, 69]. SCVs are slow-growing, drug-resistant mutants of gram-positive and -negative bacteria, and have been isolated during the long-term treatment with antimicrobial agents, such as gentamicin and trimethoprim-sulfamethoxazole (SXT); SCVs cause persistent and recurrent infections [68, 70-72], and examples include our reported case, daptomycin-resistant VISA SCV [69]. Therefore, the sticky intercellular substance may play a role in low-level vancomycin resistance. In the case of the 0579 (Fig. 3Cb), the abnormal cell surface with accumulated cell walls along the cell separation site or the irregular was more obvious than the 0380 and 0553. No intercellular sticky substance was observed for RS08 (Fig. 3D).

VISA was first described by Hiramatsu et al. in 1997 from Japan, in which VISA (ST5/SCC*mecII* HA-MRSA) with vancomycin MIC of  $8\ \mu\text{g}/\text{mL}$  led to failed treatment by vancomycin of an inpatient with long-term infections, which

started with a surgical site infection [46]. hVISA (ST5/SCC*mecII* HA-MRSA), with vancomycin MIC of  $3\ \mu\text{g}/\text{mL}$ , was isolated by the same group in 1996 from an inpatient's MRSA pneumonia with ineffective vancomycin therapy [50]. hVISA cultures spontaneously produce VISA cells [38]. Also, cell wall thickening is a common phenotype of VISA and hVISA [73].

The resistance phenotype was soon recognized around the world. Initially, it was generally considered that hVISA is associated with the HA-MRSA genetic background. However, hVISA of the ST72/SCC*mecIV* CA-MRSA lineage was reported from a vancomycin treatment failure case in 2012 [74]. In the present study, we isolated four PVL-positive CA-MRSA lineages (ST1, ST30, ST152, and ST154) of hVISA from two HIV-infected prisoners and two healthy hospital workers in Krasnoyarsk (or a related region) in 2016-2017. PVL-positive hVISA cases, such as ST239/SCC*mecIII* MRSA or ST121/SCC*mecIV* MRSA, has also been reported in 2019 from China [75]. CA-MRSA-type hVISA may be increasing.

The features of hVISA are summarized in Fig. 4 [31-33, 38, 76-86]. Selective pressure with vancomycin allows vancomycin-susceptible *S. aureus* (VSSA/MRSA) to yield hVISA, VISA, and slow-growth sVISA (SCVs), sequentially and in a stepwise manner. SCVs of hVISA can be selected under the long-term pressure of vancomycin *in vitro* [76, 79]; sVISA exhibits MIC of VRSA ( $\geq 16\ \mu\text{g}/\text{mL}$ ), although the phenotype is unstable. The hVISA and VISA phenotypes are attributed to, for example, the mutations of the two component regulatory systems, *graRS*, *vraSR*, and *walkR*, and the hVISA-to-VISA conversion occurs through additional roughly 20 gene mutations, suggesting a series of genetic mutation processes. Regarding vancomycin MICs, the use of MH and BHI media and incubation time of 18-24 and 48 hours (or more) causes confusion on evaluating and comparing reduced vancomycin susceptibilities (MICs) among clinical isolates.

Significant points in our current study are summarized in Fig. 5. They include i) spread of PVL-positive hVISA among HIV-infected prisoners and hospital workers, ii) unique cell structures of low-level vancomycin resistant MRSA cells, such as abnormal cell surface with accumulated cell walls along the cell separation site or the irregular, multiple cross, and thick septum, and the intercellular sticky substance, which is similar to those of SCVs, and iii) HA-MRSA-like marked *mecA* resistance to oxacillin and imipenem/meropenem (carbapenems) in CA-MRSA, alerting us to a possible new class of MRSA. Further large scale and molecular level studies are required.

## Acknowledgments

We thank Wei-Chun Hung, Wataru Higuchi, Kyoko Kuwahara, and Longzhu Cui for technical information and

encouragement. This study was supported by the institutions of the authors, including personal money obtained from lectures at universities and colleges (TY).

## Conflict of Interest Statement

The authors declare that they have no conflicts of interest.

## References

1. Klevens RM, Morrison MA, Nadle J, Petit S, Gershman K, Ray S, et al. Invasive methicillin-resistant *Staphylococcus aureus* infections in the United States. *JAMA*. 2007;298(15):1763–71. <https://doi.org/10.1001/jama.298.15.1763>
2. David MZ, Daum RS. Community-associated methicillin-resistant *Staphylococcus aureus*: epidemiology and clinical consequences of an emerging epidemic. *Clin Microbiol Rev*. 2010;23(3):616–87. <https://doi.org/10.1128/CMR.00081-09>
3. Otto M. Community-associated MRSA: what makes them special? *Int J Med Microbiol*. 2013;303(6-7):324–30. <https://doi.org/10.1016/j.ijmm.2013.02.007>
4. Lindsay JA. Hospital-associated MRSA and antibiotic resistance – What have we learned from genomics? *Int J Med Microbiol*. 2013;303(6-7):318–23. <https://doi.org/10.1016/j.ijmm.2013.02.005>
5. Lakhundi S, Zhang K. Methicillin-Resistant *Staphylococcus aureus*: Molecular Characterization, Evolution, and Epidemiology. *Clin Microbiol Rev*. 2018;31(4):e00020–18. <https://doi.org/10.1128/CMR.00020-18>
6. World Health Organization [site]. Antimicrobial resistance: global report on surveillance. Geneva: World Health Organization; 2014 [cited 2020 Dec 20]. 257 p. Available from: <https://www.who.int/drugresistance/documents/surveillance-report/en/>
7. Naimi TS, LeDell KH, Como-Sabetti K, Borchardt SM, Boxrud DJ, Etienne J, et al. Comparison of community- and health care-associated methicillin-resistant *Staphylococcus aureus* infection. *JAMA*. 2003;290(22):2976–84. <https://doi.org/10.1001/jama.290.22.2976>
8. Harinsein L, Schafer J, D'Amico F. Risk factors associated with the conversion of methicillin-resistant *Staphylococcus aureus* colonisation to healthcare-associated infection. *J Hosp Infect*. 2011;79(3):194–7. <https://doi.org/10.1016/j.jhin.2011.03.017>
9. Harris SR, Feil EJ, Holden MT, Quail MA, Nickerson EK, Chantrelita N, et al. Evolution of MRSA during hospital transmission and intercontinental spread. *Science*. 2010;327(5964):469–74. <https://doi.org/10.1126/science.1182395>
10. Kuroda M, Ohta T, Uchiyama I, Baba T, Yuzawa H, Kobayashi I, et al. Whole genome sequencing of methicillin-resistant *Staphylococcus aureus*. *Lancet*. 2001;357(9264):1225–40. [https://doi.org/10.1016/s0140-6736\(00\)04403-2](https://doi.org/10.1016/s0140-6736(00)04403-2)
11. International Working Group on the Classification of Staphylococcal Cassette Chromosome Elements (IWG-SCC). Classification of staphylococcal cassette chromosome mec (SCCmec): guidelines for reporting novel SCCmec elements. *Antimicrob Agents Chemother*. 2009;53(12):4961–7. <https://doi.org/10.1128/AAC.00579-09>
12. Centers for Disease Control and Prevention (CDC). Four pediatric deaths from community-acquired methicillin-resistant *Staphylococcus aureus* - Minnesota and North Dakota, 1997-1999. *MMWR Morb Mortal Wkly Rep*. 1999;48(32):707–10.
13. Braun T, Kahanov L. Community-associated methicillin-resistant *Staphylococcus aureus* infection rates and management among student-athletes. *Med Sci Sports Exerc*. 2018;50(9):1802–9. <https://dx.doi.org/10.1249/MSS.0000000000001649>
14. Diep BA, Otto M. The role of virulence determinants in community-associated MRSA pathogenesis. *Trends Microbiol*. 2008;16(8):361–9. <https://doi.org/10.1016/j.tim.2008.05.002>
15. Tenover FC, Goering RV. Methicillin-resistant *Staphylococcus aureus* strain USA300: origin and epidemiology. *J Antimicrob Chemother*. 2009;64(3):441–6. <https://doi.org/10.1093/jac/dkp241>
16. Centers for Disease Control and Prevention (CDC). Severe methicillin-resistant *Staphylococcus aureus* community-acquired pneumonia associated with influenza—Louisiana and Georgia, December 2006–January 2007. *Morb Mortal Wkly Rep*. 2007;56(14):325–9.
17. Diep BA, Gill SR, Chang RF, Phan TH, Chen JH, Davidson MG, et al. Complete genome sequence of USA300, an epidemic clone of community-acquired methicillin-resistant *Staphylococcus aureus*. *Lancet*. 2006;367(9512):731–9. [https://doi.org/10.1016/S0140-6736\(06\)68231-7](https://doi.org/10.1016/S0140-6736(06)68231-7)
18. Isobe H, Takano T, Nishiyama A, Hung WC, Kuniyuki S, Shibuya Y, et al. Evolution and virulence of Pantone-Valentine leukocidin-positive ST30 methicillin-resistant *Staphylococcus aureus* in the past 30 years in Japan. *Biomed Res*. 2012;33(2):97–109. <https://doi.org/10.2220/biomedres.33.97>
19. Hung WC, Takano T, Higuchi W, Iwao Y, Khokhlova O, Teng LJ, et al. Comparative genomics of community-acquired ST59 methicillin-resistant *Staphylococcus aureus* in Taiwan: novel mobile resistance structures with IS1216V. *PLoS One*. 2012;7(10):e46987. <https://doi.org/10.1371/journal.pone.0046987>

20. Fluit AC, Carpaij N, Majoor EA, Weinstein RA, Aroutcheva A, Rice TW, et al. Comparison of an ST80 MRSA strain from the USA with European ST80 strains. *J Antimicrob Chemother.* 2015;70(3):664–9. <https://doi.org/10.1093/jac/dku459>
21. Strauß L, Stegger M, Akpaka PE, Alabi A, Breurec S, Coombs G, et al. Origin, evolution, and global transmission of community-acquired *Staphylococcus aureus* ST8. *Proc Natl Acad Sci U S A.* 2017;114(49):E10596–E10604. <https://dx.doi.org/10.1073/pnas.1702472114>
22. Copin R, Sause WE, Fulmer Y, Balasubramanian D, Dyzenhaus S, Ahmed JM, et al. Sequential evolution of virulence and resistance during clonal spread of community-acquired methicillin-resistant *Staphylococcus aureus*. *Proc Natl Acad Sci U S A.* 2019;116(5):1745–54. <https://dx.doi.org/10.1073/pnas.1814265116>
23. Shallcross LJ, Fragaszy E, Johnson AM, Hayward AC. The role of the Panton-Valentine leucocidin toxin in staphylococcal disease: a systematic review and meta-analysis. *Lancet Infect Dis.* 2013;13(1):43–54. [https://doi.org/10.1016/S1473-3099\(12\)70238-4](https://doi.org/10.1016/S1473-3099(12)70238-4)
24. Yamamoto T, Hung WC, Takano T, Nishiyama A. Genetic nature and virulence of community-associated methicillin-resistant *Staphylococcus aureus*. *BioMedicine.* 2013;3:2–18.
25. Baranovich T, Potapov V, Yamamoto T. The first isolation of Panton-Valentine leukocidin (PVL) positive community-acquired methicillin-resistant *Staphylococcus aureus* (CA-MRSA) in Russia. *Euro Surveill.* 2007;12(3):E070315.070314. <https://doi.org/10.2807/esw.12.11.03157-en>
26. Nichol KA, Adam HJ, Golding GR, Lagacé-Wiens PRS, Karlowsky JA, Hoban DJ, et al. Characterization of MRSA in Canada from 2007 to 2016. *J Antimicrob Chemother.* 2019;74(Suppl 4):iv55–iv63. <https://dx.doi.org/10.1093/jac/dkz288>
27. David MZ, Daum RS. Treatment of *Staphylococcus aureus* infections. *Curr Top Microbiol Immunol.* 2017;409:325–83. [https://doi.org/10.1007/82\\_2017\\_42](https://doi.org/10.1007/82_2017_42)
28. Khan A, Wilson B, Gould IM. Current and future treatment options for community-associated MRSA infection. *Expert Opin Pharmacother.* 2018;19(5):457–70. <https://doi.org/10.1080/14656566.2018.1442826>
29. Clinical and Laboratory Standards Institute. Performance standards for antimicrobial susceptibility testing. 30th ed. CLSI supplement M100. Wayne PA, USA: Clinical and Laboratory Standards Institute; 2020. 13 p.
30. McGuinness WA, Malachowa N, DeLeo FR. Vancomycin Resistance in *Staphylococcus aureus*. *Yale J Biol Med.* 2017;90(2):269–81.
31. Howden BP, Davies JK, Johnson PDR, Stinear TP, Grayson ML. Reduced vancomycin susceptibility in *Staphylococcus aureus*, including vancomycin-intermediate and heterogeneous vancomycin-intermediate strains: resistance mechanisms, laboratory detection, and clinical implications. *Clin Microbiol Rev.* 2010;23(1):99–139. <https://doi.org/10.1128/CMR.00042-09>
32. Hiramatsu K, Kayayama Y, Matsuo M, Aiba Y, Saito M, Hishinuma T, et al. Vancomycin-intermediate resistance in *Staphylococcus aureus*. *J Glob Antimicrob Resist.* 2014;2(4):213–24. <https://dx.doi.org/10.1016/j.jgar.2014.04.006>
33. Hu Q, Peng H, Rao X. Molecular Events for Promotion of Vancomycin Resistance in Vancomycin Intermediate *Staphylococcus aureus*. *Front Microbiol.* 2016;7:1601. <https://dx.doi.org/10.3389/fmicb.2016.01601>
34. Lodise TP, Graves J, Evans A, Graffunder E, Helmecke M, Lomaestro BM, et al. Relationship between vancomycin MIC and failure among patients with methicillin-resistant *Staphylococcus aureus* bacteremia treated with vancomycin. *Antimicrob Agents Chemother.* 2008;52(9):3315–20. <https://dx.doi.org/10.1128/AAC.00113-08>
35. Mendes RE, Deshpande LM, Smyth DS, Shopsin B, Farrell DJ, Jones RN. Characterization of methicillin-resistant *Staphylococcus aureus* strains recovered from a phase IV clinical trial for linezolid versus vancomycin for treatment of nosocomial pneumonia. *J Clin Microbiol.* 2012;50(11):3694–702. <https://doi.org/10.1128/JCM.02024-12>
36. Bakthavatchalam YD, Babu P, Munusamy E, Dwarakanathan HT, Rupali P, Zervos M, et al. Genomic insights on heterogeneous resistance to vancomycin and teicoplanin in methicillin-resistant *Staphylococcus aureus*: A first report from South India. *PLoS One.* 2019;14(12):e0227009. <https://doi.org/10.1371/journal.pone.0227009>
37. Ozmen Capin BB, Tekeli A, Karahan ZC. Evaluation of the presence and characterization of vancomycin-intermediate and heterogeneous vancomycin-intermediate level resistance among bloodstream isolates of methicillin-resistant *Staphylococcus aureus*. *Microb Drug Resist.* 2020;26(3):238–44. <https://doi.org/10.1089/mdr.2019.0178>
38. Matsuo M, Cui L, Kim J, Hiramatsu K. Comprehensive identification of mutations responsible for heterogeneous vancomycin-intermediate *Staphylococcus aureus* (hVISA)-to-VISA conversion in laboratory-generated VISA strains derived from hVISA clinical strain Mu3. *Antimicrob Agents Chemother.* 2013;57(12):5843–53. <https://dx.doi.org/10.1128/AAC.00425-13>
39. Lee MY, Lee WI, Kim MH, Kang SY, Kim YJ. Etest methods for screening heterogeneous vancomycin-intermediate *Staphylococcus aureus* (hVISA) strains. *Curr Microbiol.* 2020;77(10):3158–67. <https://doi.org/10.1007/s00284-020-02123-y>
40. Liu C, Chambers HF. *Staphylococcus aureus* with heterogeneous resistance to vancomycin: epidemiology, clinical significance, and critical assessment of diagnostic methods. *Antimicrob Agents Chemother.* 2003;47(10):3040–5. <https://dx.doi.org/10.1128/aac.47.10.3040-3045.2003>
41. Chang SC, Liu TP, Chen CJ, Lin LC, Lu JJ. Detection of heterogeneous vancomycin-intermediate *Staphylococcus aureus* isolates using a combination of  $\delta$ -hemolysis assay and Etest. *Diagn Microbiol Infect Dis.* 2015;81(4):246–50. <https://doi.org/10.1016/j.diagmicrobio.2014.12.006>



42. Asakura K, Azechi T, Sasano H, Matsui H, Hanaki H, Miyazaki M, et al. Rapid and easy detection of low-level resistance to vancomycin in methicillin-resistant *Staphylococcus aureus* by matrix-assisted laser desorption ionization time-of-flight mass spectrometry. *PLoS One*. 2018;13(13):e0194212. <https://doi.org/10.1371/journal.pone.0194212>
43. Castro BE, Berrio M, Vargas ML, Carvajal LP, Millan LV, Rios R, et al. Detection of heterogeneous vancomycin intermediate resistance in MRSA isolates from Latin America. *J Antimicrob Chemother*. 2020;75(9):2424–31. <https://doi.org/10.1093/jac/dkaa221>
44. Khokhlova OE, Hung WC, Wan TW, Iwao Y, Takano T, Higuchi W, et al. Healthcare- and community-associated methicillin-resistant *Staphylococcus aureus* (MRSA) and fatal pneumonia with pediatric deaths in Krasnoyarsk, Siberian Russia: unique MRSA's multiple virulence factors, genome, and stepwise evolution. *PLoS One*. 2015;10(6):e0128017. <https://doi.org/10.1371/journal.pone.0128017>
45. Wan TW, Khokhlova OE, Iwao Y, Higuchi W, Hung WC, Reva IV, et al. Complete circular genome sequence of successful ST8/SCCmecIV community-associated methicillin-resistant *Staphylococcus aureus* (OC8) in Russia: one-megabase genomic inversion, IS256's spread, and evolution of Russia ST8-IV. *PLoS One*. 2016;11(10):e0164168. <https://doi.org/10.1371/journal.pone.0164168>
46. Hiramatsu K, Hanaki H, Ino T, Yabuta K, Oguri T, Tenover FC. Methicillin-resistant *Staphylococcus aureus* clinical strain with reduced vancomycin susceptibility. *J Antimicrob Chemother*. 1997;40(1):135–6. <https://doi.org/10.1093/jac/40.1.135>
47. Kuroda M, Ohta T, Uchiyama I, Baba T, Yuzawa H, Kobayashi I, et al. Whole genome sequencing of methicillin-resistant *Staphylococcus aureus*. *Lancet*. 2001;357(9264):1225–40. [https://doi.org/10.1016/S0140-6736\(00\)04403-2](https://doi.org/10.1016/S0140-6736(00)04403-2)
48. Jin J, Ito T, Hiramatsu K. Molecular epidemiological characterization of 46 vancomycin-intermediate *Staphylococcus aureus* strains isolated worldwide. *Juntendo Med J*. 2011;57:494–503. Japanese.
49. Khokhlova O, Tomita Y, Hung WC, Takano T, Iwao Y, Higuchi W, et al. Elderly infection in the community due to ST5/SCCmecII methicillin-resistant *Staphylococcus aureus* (the New York/Japan clone) in Japan: Pantone-Valentine leukocidin-negative necrotizing pneumonia. *J Microbiol Immunol Infect*. 2015;48(3):335–9. <https://dx.doi.org/10.1016/j.jmii.2012.09.004>
50. Hiramatsu K, Aritaka N, Hanaki H, Kawasaki S, Hosoda Y, Hori S, et al. Dissemination in Japanese hospitals of strains of *Staphylococcus aureus* heterogeneously resistant to vancomycin. *Lancet*. 1997;350(9092):1670–3. [https://doi.org/10.1016/S0140-6736\(97\)07324-8](https://doi.org/10.1016/S0140-6736(97)07324-8)
51. Katayama Y, Murakami-Kuroda H, Cui L, Hiramatsu K. Selection of heterogeneous vancomycin-intermediate *Staphylococcus aureus* by imipenem. *Antimicrob Agents Chemother*. 2009;53(8):3190–6. <https://dx.doi.org/10.1128/AAC.00834-0>
52. Dominguez TJ. It's not a spider bite, it's community-acquired methicillin-resistant *Staphylococcus aureus*. *J Am Board Fam Pract*. 2004;17(3):220–6. <https://dx.doi.org/10.3122/jabfm.17.3.220>
53. Takano T, Higuchi W, Yamamoto T. Superior in vitro activity of carbapenems over anti-methicillin-resistant *Staphylococcus aureus* (MRSA) and some related antimicrobial agents for community-acquired MRSA but not for hospital-acquired MRSA. *J Infect Chemother*. 2009;15(1):54–7. <https://doi.org/10.1007/s10156-008-0665-5>
54. Krziwanek K, Luger C, Sammer B, Stumvoll S, Stammler M, Metzgercek S, et al. PVL-positive MRSA in Austria. *Eur J Clin Microbiol Infect Dis*. 2007;26(12):931–5. <https://dx.doi.org/10.1007/s10096-007-0391-4>
55. Harbarth S, François P, Shrenzel J, Fankhauser-Rodriguez C, Hugonnet S, Koessler T, et al. Community-associated methicillin-resistant *Staphylococcus aureus*, Switzerland. *Emerg Infect Dis*. 2005;11(6):962–5. <https://dx.doi.org/10.3201/eid1106.041308>
56. Müller-Premru M, Strommenger B, Alikadic N, Witte W, Friedrich AW, Seme K, et al. New strains of community-acquired methicillin-resistant *Staphylococcus aureus* with Pantone-Valentine leukocidin causing an outbreak of severe soft tissue infection in a football team. *Eur J Clin Microbiol Infect Dis*. 2005;24(12):848–50. <https://dx.doi.org/10.1007/s10096-005-0048-0>
57. Faria NA, Oliveira DC, Westh H, Monnet DL, Larsen AR, Skov R, et al. Epidemiology of emerging methicillin-resistant *Staphylococcus aureus* (MRSA) in Denmark: a nationwide study in a country with low prevalence of MRSA infection. *J Clin Microbiol*. 2005;43(4):1836–42. <https://dx.doi.org/10.1128/JCM.43.4.1836-1842.2005>
58. Berglund C, Mölling P, Sjöberg L, Söderquist B. Multilocus sequence typing of methicillin-resistant *Staphylococcus aureus* from an area of low endemicity by real-time PCR. *J Clin Microbiol*. 2005;43(9):4448–54. <https://dx.doi.org/10.1128/JCM.43.9.4448-4454.2005>
59. Rossney AS, Shore AC, Morgan PM, Fitzgibbon MM, O'Connell B, Coleman DC. The emergence and importation of diverse genotypes of methicillin-resistant *Staphylococcus aureus* (MRSA) harboring the Pantone-Valentine leukocidin gene (*pvl*) reveal that *pvl* is a poor marker for community-acquired MRSA strains in Ireland. *J Clin Microbiol*. 2007;45(8):2554–63. <https://dx.doi.org/10.1128/JCM.00245-07>
60. Yamaguchi T, Okamura S, Miura Y, Koyama S, Yanagisawa H, Matsumoto T. Molecular Characterization of Community-Associated Methicillin-Resistant *Staphylococcus aureus* Isolated from Skin and Pus Samples of Outpatients in Japan. *Microb Drug Resist*. 2015;21(4):441–7. <https://dx.doi.org/10.1089/mdr.2014.0153>
61. Indráková A, Mašláňová I, Mrkva O, Bendíčková K, Vrbovská V, Doškař J, et al. Draft Genome Sequence of the Pantone-Valentine Leukocidin-Producing *Staphylococcus aureus* Sequence Type 154 Strain NRL 08/001, Isolated from a Fatal Case of Necrotizing

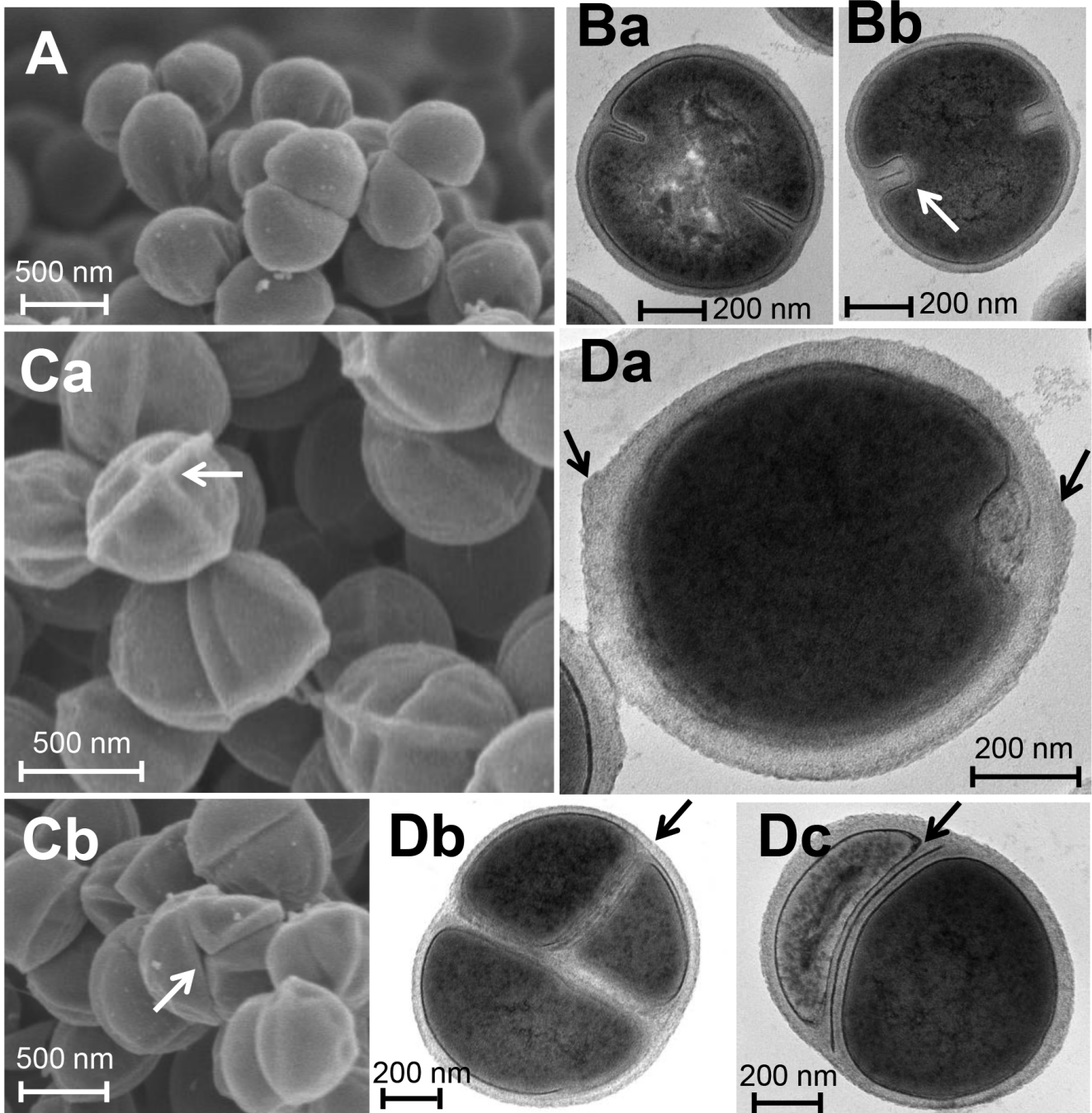
- Pneumonia. *Microbiol Resour Announc*. 2019;8(47):e01299–19. <https://dx.doi.org/10.1128/MRA.01299-19>
62. Orth D, Grif K, Erdenechimeg L, Battogtokh C, Hosbayar T, Strommenger B, et al. Characterization of methicillin-resistant *Staphylococcus aureus* from Ulaanbaatar, Mongolia. *Eur J Clin Microbiol Infect Dis*. 2006;25(2):104–7. <https://doi.org/10.1007/s10096-006-0102-6>
63. Kardén-Lilja M, Ibrahim S, Vuopio-Varkila J, Salmenlinna S, Lyytikäinen O, Siira L, et al. Panton-Valentine leukocidin genes and staphylococcal chromosomal cassette mec types amongst Finnish community-acquired methicillin-resistant *Staphylococcus aureus* strains, 1997–1999. *Eur J Clin Microbiol Infect Dis*. 2007;26(10):729–33. <https://dx.doi.org/10.1007/s10096-007-0334-0>
64. Takadama S, Nakaminami H, Aoki S, Akashi M, Wajima T, Ikeda M, et al. Prevalence of skin infections caused by Panton-Valentine leukocidin-positive methicillin-resistant *Staphylococcus aureus* in Japan, particularly in Ishigaki, Okinawa. *J Infect Chemother*. 2017;23(11):800–3. <https://doi.org/10.1016/j.jiac.2017.04.016>
65. Ikeuchi K, Adachi E, Sasaki T, Suzuki M, Lim LA, Saito M, et al. An outbreak of USA300 MRSA among people with HIV in Japan. *J Infect Dis*. 2020:jiaa651. <https://doi.org/10.1093/infdis/jiaa651>
66. Enright MC, Robinson DA, Randle G, Feil EJ, Grundmann H, Spratt BG. The evolutionary history of methicillin-resistant *Staphylococcus aureus* (MRSA). *Proc Natl Acad Sci U S A*. 2002;99(11):7687–92. <https://doi.org/10.1073/pnas.122108599>
67. Orii KO, Iwao Y, Higuchi W, Takano T, Yamamoto T. Molecular characterization of methicillin-resistant *Staphylococcus aureus* from a fatal case of necrotizing fasciitis in an extremely low-birth-weight infant. *Clin Microbiol Infect*. 2010;16(3):289–92. <https://dx.doi.org/10.1111/j.1469-0691.2009.02806.x>
68. Proctor RA, von Eiff C, Kahl BC, Becker K, McNamara P, Herrmann M, et al. Small colony variants: a pathogenic form of bacteria that facilitates persistent and recurrent infections. *Nat Rev Microbiol*. 2006;4(4):295–305. <https://dx.doi.org/10.1038/nrmicro1384>
69. Lin YT, Tsai JC, Yamamoto T, Chen HJ, Hung WC, Hsueh PR, et al. Emergence of a small colony variant of vancomycin-intermediate *Staphylococcus aureus* in a patient with septic arthritis during long-term treatment with daptomycin. *J Antimicrob Chemother*. 2016;71(7):1807–14. <https://dx.doi.org/10.1093/jac/dkw060>
70. Cao S, Huseby DL, Brandis G, Hughes D. Alternative evolutionary pathways for drug-resistant small colony variant mutants in *Staphylococcus aureus*. *mBio*. 2017;8(3):e00358–17. <https://doi.org/10.1128/mBio.00358-17>
71. Al Ahmar R, Kirby BD, Yu HD. Pyrimidine biosynthesis regulates the small-colony variant and mucoidy in *Pseudomonas aeruginosa* through sigma factor competition. *J Bacteriol*. 2018;201(1):e00575–18. <https://doi.org/10.1128/JB.00575-18>
72. Côté-Gravel J, Brouillette E, Malouin F. Vaccination with a live-attenuated small-colony variant improves the humoral and cell-mediated responses against *Staphylococcus aureus*. *PLoS One*. 2019;14(12):e0227109. <https://doi.org/10.1371/journal.pone.0227109>
73. Cui L, Ma X, Sato K, Okuma K, Tenover FC, Mamizuka EM, et al. Cell wall thickening is a common feature of vancomycin resistance in *Staphylococcus aureus*. *J Clin Microbiol*. 2003;41(1):5–14. <https://dx.doi.org/10.1128/JCM.41.1.5-14.2003>
74. Chung DR, Baek JY, Kim HA, Lim MH, Kim SH, Ko KS, et al. First report of vancomycin-intermediate resistance in sequence type 72 community genotype methicillin-resistant *Staphylococcus aureus*. *J Clin Microbiol*. 2012;50(7):2513–4. <https://dx.doi.org/10.1128/JCM.00590-12>
75. Shen P, Zhou K, Wang Y, Song J, Liu Y, Zhou Y, et al. High prevalence of a globally disseminated hypervirulent clone, *Staphylococcus aureus* CC121, with reduced vancomycin susceptibility in community settings in China. *J Antimicrob Chemother*. 2019;74(9):2537–43. <https://dx.doi.org/10.1093/jac/dkz232>
76. Saito M, Katayama Y, Hishinuma T, Iwamoto A, Aiba Y, Kuwahara-Arai K, et al. «Slow VISA,» a novel phenotype of vancomycin resistance, found in vitro in heterogeneous vancomycin-intermediate *Staphylococcus aureus* strain Mu3. *Antimicrob Agents Chemother*. 2014;58(9):5024–35. <https://doi.org/10.1128/AAC.02470-13>
77. Roch M, Clair P, Renzoni A, Reverdy M-E, Dauwalder O, Bes M, et al. Exposure of *Staphylococcus aureus* to subinhibitory concentrations of  $\beta$ -lactam antibiotics induces heterogeneous vancomycin-intermediate *Staphylococcus aureus*. *Antimicrob Agents Chemother*. 2014;58(9):5306–14. <https://doi.org/10.1128/AAC.02574-14>
78. Howden BP, Peleg AY, Stinear TP. The evolution of vancomycin intermediate *Staphylococcus aureus* (VISA) and heterogeneous-VISA. *Infect Genet Evol*. 2014;21:575–82. <https://doi.org/10.1016/j.meegid.2013.03.047>
79. Matsuo M, Hishinuma T, Katayama Y, Hiramatsu K. A mutation of RNA polymerase  $\beta'$  subunit (RpoC) converts heterogeneously vancomycin-intermediate *Staphylococcus aureus* (hVISA) into «slow VISA». *Antimicrob Agents Chemother*. 2015;59(7):4215–25. <https://doi.org/10.1128/AAC.00135-15>
80. Matsuo M, Yamamoto N, Hishinuma T, Hiramatsu K. Identification of a Novel Gene Associated with High-Level  $\beta$ -Lactam Resistance in Heterogeneous Vancomycin-Intermediate *Staphylococcus aureus* Strain Mu3 and Methicillin-Resistant *S. aureus* Strain N315. *Antimicrob Agents Chemother*. 2019;63(2):e00712–18. <https://doi.org/10.1128/AAC.00712-18>
81. Haaber J, Friberg C, McCreary M, Lin R, Cohen SN, Ingmer H. Reversible antibiotic tolerance induced in *Staphylococcus aureus* by concurrent drug exposure. *mBio*. 2015;6(1):e02268–14. <https://doi.org/10.1128/mBio.02268-14>
82. Katayama Y, Azechi T, Miyazaki M, Takata T, Sekine M, Matsui H, et al. Prevalence of slow-growth vancomycin nonsusceptibility in methicillin-resistant *Staphylococcus aureus*. *Antimicrob Agents Chemother*. 2017;61(11):e00452–17. <https://doi.org/10.1128/AAC.00452-17>



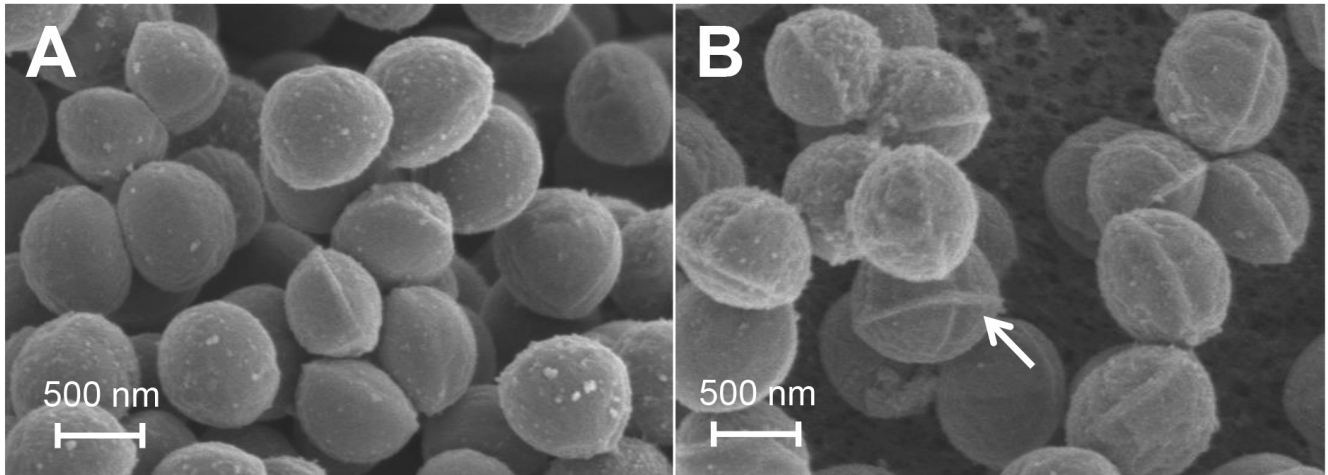
- 
83. McGuinness WA, Malachowa N, DeLeo FR. Vancomycin resistance in *Staphylococcus aureus*. *Yale J Biol Med*. 2017;90(2):269–81.
84. Lin LC, Chang SC, Ge MC, Liu TP, Lu JJ. Novel single-nucleotide variations associated with vancomycin resistance in vancomycin-intermediate *Staphylococcus aureus*. *Infect Drug Resist*. 2018;11:113–23. <https://doi.org/10.2147/IDR.S148335>
85. Xu J, Pang L, Ma XX, Hu J, Tian Y, Yang YL, et al. Phenotypic and molecular characterisation of *Staphylococcus aureus* with reduced vancomycin susceptibility derived in vitro. *Open Med (Wars)*. 2018;13:475–86. <https://doi.org/10.1515/med-2018-0071>
86. Gao C, Dai Y, Chang W, Fang C, Wang Z, Ma X. VraSR has an important role in immune evasion of *Staphylococcus aureus* with low level vancomycin resistance. *Microbes Infect*. 2019;21(8-9):361–7. <https://doi.org/10.1016/j.micinf.2019.04.003>

**Figures**

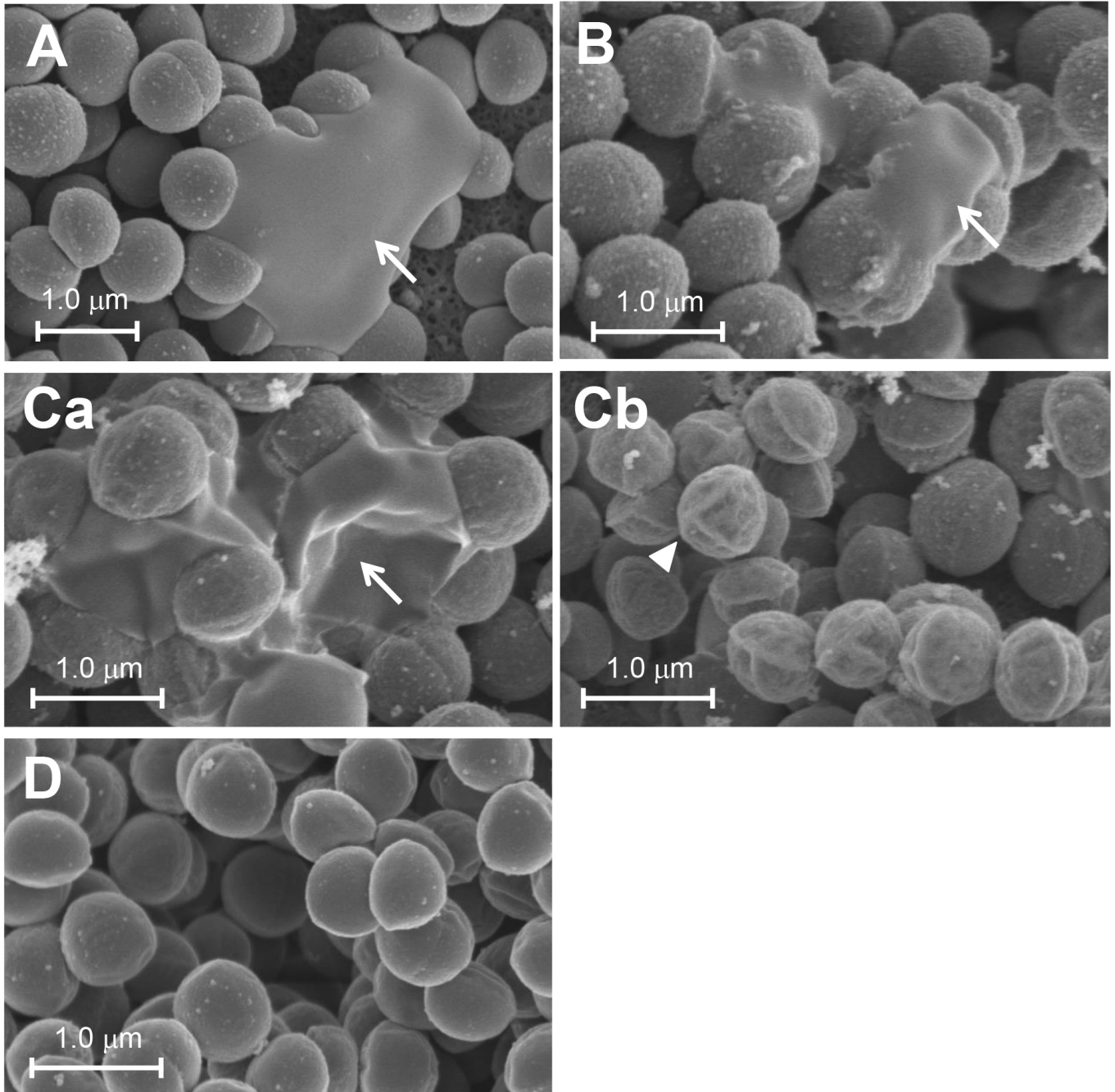
**Figure 1.** Electron micrographs showing the bacterial cell structures of PVL-positive Krasnoyarsk CA-MRSA 0409 (A, B) and its vancomycin-selected mutant 0409v (C, D). A, Ca, and Cb are scanning electron micrographs (SEM); Ba, Bb and Da to Dc are transmission electron micrographs (TEM). The arrow in Bb indicates the thick septum, which may interfere with the action of vancomycin. Arrows in C and D indicate the abnormal accumulation of cell walls along the cell separation site or the irregular, multiple cross-like structures.



**Figure 2.** Scanning electron micrographs showing the bacterial cell structures of the hVISA reference strain Mu3 (A) and its vancomycin-selected mutant Mu3v (B). The arrow indicates the abnormal accumulation of cell walls along the cell separation site or the irregular, multiple cross-like structure.



**Figure 3.** Scanning electron micrographs showing the bacterial cell structures of Russian PVL-positive CA-MRSA. Strains: A, 0380 (from Krasnoyarsk); B, 0553 (from Krasnoyarsk); C (a and b), 0579 (from Krasnoyarsk); D, RS08 (from Vladivostok). Arrows, in A, B, and Ca, indicate a sticky intercellular substance. An arrowhead, in Cb, indicates the abnormal accumulation of cell walls along the cell separation site or the irregular, multiple cross-like structures.



**Figure 4.** Sequential conversion between hVISA, VISA, and sVISA. Abbreviations: VSSA, vancomycin-susceptible *S. aureus* (MRSA); hVISA, heterogenous VISA; VISA, vancomycin-intermediate *S. aureus* (MRSA); sVISA, slow-growth VISA; SCVs, small colony variants; Van, vancomycin. hVISA consists of a major population of mother cells, which can yield VISA daughter cells, and a small population of VISA daughter cells. References are 31-33, 38,76-86.

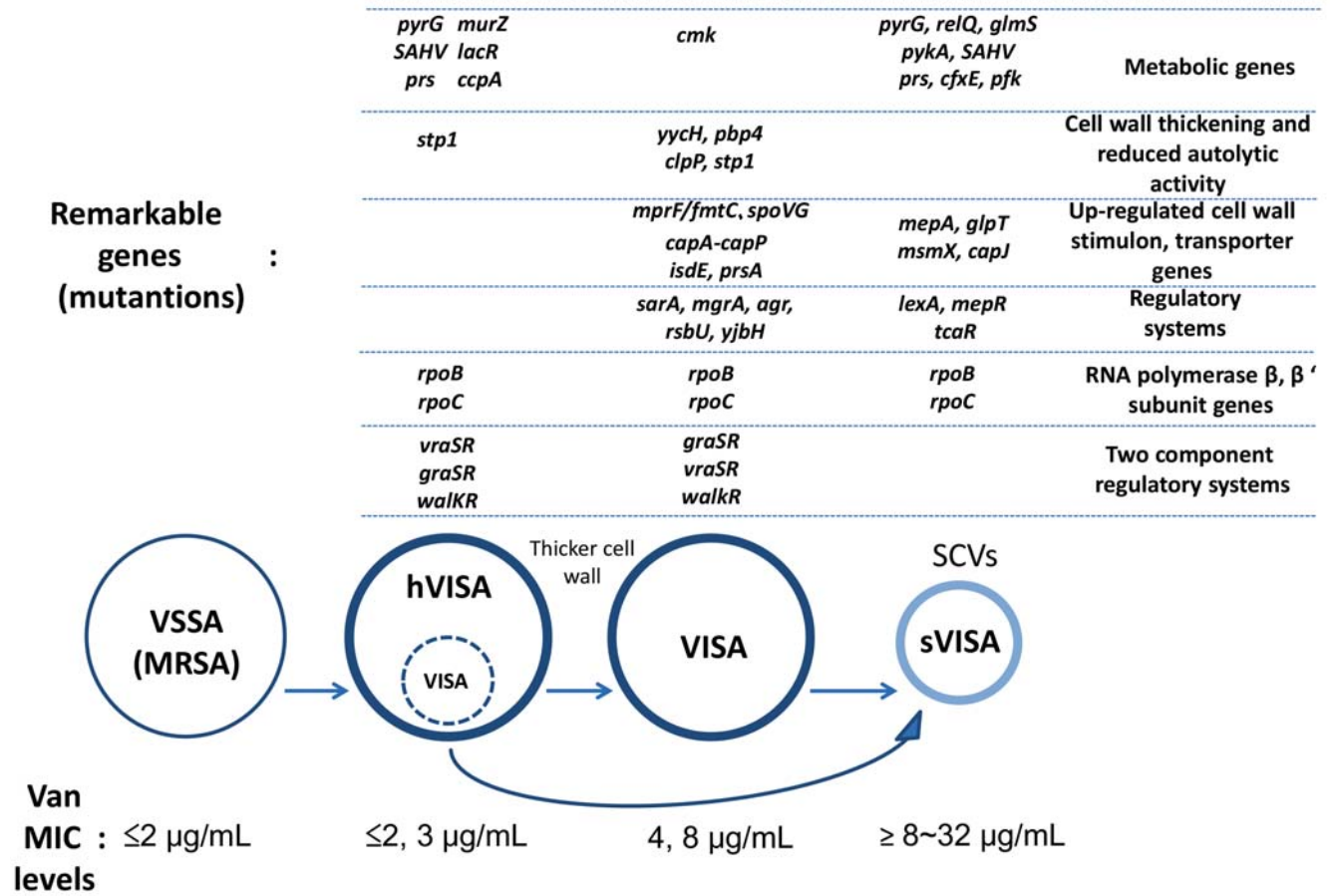
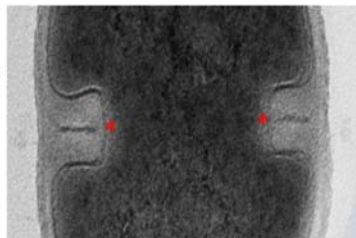




Figure 5. Highlights in this study.

### What is hVISA?

- hVISA is “susceptible” to vancomycin (MICs,  $\leq 2$   $\mu\text{g/mL}$  or slightly higher, 3  $\mu\text{g/mL}$ ) in routine susceptibility testing; however, it includes a subpopulation of VISA daughter cells, with MICs of 4-8  $\mu\text{g/mL}$ , and thus hVISA becomes VISA during the course of long-term therapy, resulting in vancomycin treatment failure.
- hVISA detection methods include, for example, macro Etest, PAP-AUC method, and micro broth dilution method. hVISA is, however, not routinely diagnosed in clinical labs.
- VISA (and a part of hVISA) has a thick cell wall, particularly thick septum, thus blocking the vancomycin’s approach to the target site\* of cell wall peptidoglycan synthesis, as shown in the TEM photo.
- The hVISA-to-VISA conversion and VISA phenotype comprise a series of genetic mutation processes.
- PVL-positive hVISA may be increasing through transmission among individuals in community settings, including cases of HIV-infected prisoners and hospital workers, as shown in our current study.



### Note/Alert

- VISA or hVISA may include slow-growth bacteria; therefore, BHI media (instead of MH media) and longer incubation time are used; however, this sometimes causes confusion.
- hVISA may have a sticky intercellular substance, similarly to small colony variants (SCVs), which also exhibit drug resistance.
- The hVISA phenotype may be transient and unstable, and may be spontaneously lost during storage.
- PVL-positive hVISA, with HA-MRSA-like marked *mecA* resistance to oxacillin and imipenem/meropenem, is emerging, alerting us to a possible new class of MRSA.



## Tables

**Table 1.** Methods of susceptibility testing used in this study

Antimicrobial Agent	Methods and details of testing for:							
	Clinical isolates				Laboratory strains (stored at -80°C)			
	Method	Concentration of antimicrobial agent	Medium	Incubation	Method	Concentration of antimicrobial agent	Medium	Incubation
Oxacillin	E-test (disk diffusion)	0,016-256 µg/disk	MH agar plus 2% NaCl	24 hours	Agar dilution	0.06 – 128 µg/mL	MH agar plus 2% NaCl	24 hours
Imipenem	—	—	—	—	Agar dilution	0.008 – 128 µg/mL	MH agar	18-20 hours
Meropenem	E-test (disk diffusion)	0,002-32 µg/disk	MH agar	18 hours	Agar dilution	0.008 – 128 µg/mL	MH agar	18-20 hours
Vancomycin	E-test (disk diffusion)	0,016-256 µg/disk	MH agar	24 hours	1) Agar dilution 2) Agar dilution 3) E-test (disk diffusion)	1) 0.13 – 128 µg/mL 2) 0.13 – 128 µg/mL 3) 0,016-256 µg/disk	1) MH agar 2) BHI agar 3) MH agar	1) 24 hours 2) 24 hours 3) 24 hours
Teicoplanin	—	—	—	—	Agar dilution	1) 0.13 – 128 µg/mL 2) 0.13 – 128 µg/mL	1) MH agar 2) BHI agar	1) 18-20 hours 2) 18-20 hours
Linezolid	—	0,016-256 µg/disk	MH agar	—	Agar dilution	0.13 – 128 µg/mL	MH agar	18-20 hours
Daptomycin	—	0,016-256 µg/disk	MH agar plus 50 µg/mL (0.34 mM) CaCl <sub>2</sub>	18-20 hours	1) Agar dilution 2) Broth microdilution	1) 0.13 – 128 µg/mL 2) 0.13 – 128 µg/mL	1) MH agar plus 50 µg/mL (0.34 mM) CaCl <sub>2</sub> 2) CAMHB plus 50 µg/mL (0.34 mM) CaCl <sub>2</sub>	1) 18-20 hours 2) 18 hours
Arbekacin	—	—	—	—	Agar dilution	0.13 – 128 µg/mL	MH agar	18-20 hours
Levofloxacin	—	—	—	—	Agar dilution	0.03 – 128 µg/mL	MH agar	18-20 hours
Fosfomycin	—	—	—	—	Agar dilution	0.13 – 128 µg/mL	MH agar Plus	18-20 hours

**Note:** The minimum inhibitory concentrations (MICs) of antimicrobial agents for the clinical isolates were analyzed immediately after bacterial isolation from clinical specimens. Susceptibility testing was performed according to the procedures described by the Clinical and Laboratory Standards Institute (CLSI) [29]. —, data not examined. Abbreviation: MH agar, Muller-Hinton agar; BHI agar, brain heart infusion agar; CAMHB, cation-adjusted Muller-Hinton broth. We got the same results among MH agar dilution and E-test (disk diffusion) for vancomycin; and we also got the same results among MH agar dilution and CAMHB microdilution for daptomycin.

**Table 2.** The relevant characteristics of MRSA strains used in this study

Strain	Genotype	PVL	VAN MIC	Initial classification	Resistance			Isolation place and year (patient's age, sex, clinical condition)	Reference
					OXA MIC	IPM or MEM MIC	Others (except VAN, OXA, IPM, MEM)		
0380	ST30/SCC <i>mecI</i> V/ <i>spa</i> t012	+	3	hVISA	1.0	MEM 0.13		Krasnoyarsk, Russia, 2016 (37Y, female, nasal carrier/healthy hospital worker)	This study
0409	ST1/SCC <i>mecI</i> V/ <i>spa</i> t3896	+	3	hVISA	≥256	MEM ≥32	TET	Krasnoyarsk, Russia, 2016 (19Y, male, nasal MRSA, HIV-infected prisoner with furunculosis)	This study
0553	ST154/SCC <i>mec</i> NT/ <i>spa</i> t667	+	3	hVISA	3.0	MEM 0.75	ERY	Krasnoyarsk, Russia, 2016 (45Y, female, nasal, carrier/healthy hospital worker)	This study
0579	ST152/SCC <i>mec</i> NT/ <i>spa</i> t1096	+	3	hVISA	1.0	MEM 0.19	GEN, TET	Krasnoyarsk, Russia, 2017 (28Y, male, pus, HIV-infected prisoner with purulent wound)	This study
RS08	ST30/SCC <i>mecI</i> Vc/ <i>spa</i> 19 (t019)	+	1	CA-MRSA	32	IPM 0.06 MEM 1.0		Vladivostok, Russia, 2006 (23Y, female, pus, badminton player with furunculosis)	25, this study
Mu3	ST5/SCC <i>mecII</i> / <i>spa</i> 2(t002)	-	2 or 3	hVISA	≥256	IPM 64	GEN, FOF,	Tokyo, Japan, 1996 (64Y, male, post-lung-cancer-operation pneumonia)	38, 47, 48, 50, 51, this study
Mu50	ST5/SCC <i>mecII</i> / <i>spa</i> 2(t002)	-	8	VISA	≥256	IPM32	GEN, TET, ERY, LVX, FOF, RIF	Tokyo, Japan, 1996 (4M, male, surgical site infection)	38, 46-50, this study
OC8	ST8/SCC <i>mecI</i> Vc/ <i>spa</i> 1(t008)	-	0.5	CA-MRSA	32	IPM 0.25 MEM 2.0	LVX, CHL	Krasnoyarsk, Russia, 2007 (1Y, male, pneumonia)	44,45
OC3	ST239/SCC <i>mec-Hg</i> (SCC <i>mecIII</i> [3A&5]) / <i>spa</i> 3(t037)	-	0.5	HA-MRSA	≥256	IPM 64 MEM 32	GEN, TET, ERY, LVX, CHL	Krasnoyarsk, Russia, 2007 (46Y, male, pneumonia, sepsis)	44,45

**Note:** Abbreviation: MRSA, methicillin-resistant *Staphylococcus aureus*; PVL, Panton-Valentine leukocidin; VAN, vancomycin; OXA, oxacillin; IPM, imipenem; MEM, meropenem; TET, tetracycline; ERY, erythromycin; GEN, gentamicin; FOF, fosfomicin; LVX, levofloxacin; RIF, rifampicin; CHL, chloramphenicol; MIC, minimum inhibitory concentration (µg/ml); VISA, van-intermediate *S. aureus*, hVISA, heterogenous VISA, HIV, human immunodeficiency virus; SCC*mec*NT, SCC*mec* nontypeable; CA-MRSA, community-associated MRSA. MICs are determined by a dilution method or E-test, using Muller-Hinton (MH) agar for strains 0380, 0409, 0553, 0579, RS08, OC8, and OC3, and using brain heart infusion (BHI) agar for strains Mu3 and Mu50.

**Table 3.** MIC values of anti-MRSA agents for PVL-positive hVISA and its vancomycin-selected mutants, compared with those for hVISA and VISA reference strains

Anti-MRSA agents	MIC ( $\mu\text{g/ml}$ ) for strains:									
	0380	0553	0579	0409	0409v	Mu3	Mu3v	Mu50	Mu50v	RS08
Vancomycin	1.0	1.0	1.0	1.0 (2.0)	2.0 (4.0)	1.0 (2.0)	2.0 (4.0)	2.0 (4.0)	4.0 (8.0)	1.0
Teicoplanin	1.0	2.0	2.0	1.0 (2.0)	4.0 (4.0)	8.0 (16.0)	8.0 (16.0)	4.0 (8.0)	8.0 (16.0)	1.0
Linezolid	2.0	2.0	2.0	2.0	2.0	1.0	1.0	1.0	1.0	2.0
Daptomycin	0.5	1.0	1.0	1.0	2.0	2.0	4.0	2.0	4.0	1.0
Arbekacin	0.5	1.0	2.0	0.5	0.5	2.0	2.0	4.0	4.0	0.5
Levofloxacin	0.13	0.13	0.13	0.13	ND	8.0	8.0	8.0	ND	0.25
Fosfomycin	1.0	0.5	1.0	1.0	ND	$\geq 256$	$\geq 256$	$\geq 256$	ND	2.0

**Note:** Strains 0380, 0409, 0553, and 0579 are PVL-positive Krasnoyarsk MRSA; all the strains were stored at  $-80^{\circ}\text{C}$  before MIC experiments. Strains 0409v, Mu3v, and Mu50v are mutants of Krasnoyarsk MRSA 0409, hVISA reference strain Mu3, and VISA reference strain Mu50, respectively; the mutants being selected on vancomycin ( $4\ \mu\text{g/ml}$ )-containing Mueller-Hinton (MH) agar. MICs were determined by a dilution method using MH agar; incubation was 18 to 24 h. *S. aureus* ATCC29213 was used as a MIC standard strain. MIC values in parentheses were obtained using brain heart infusion (BHI) agar.